

## FOREWORD

Thank you very much for purchasing our tractor. We are confident it will give you many years of reliable service.

Read this manual carefully before using the tractor. The instruction in this manual set out the correct which manner of operating, maintaining and checking the tractor to ensure long-term durability.

**Please ensure correct operation of the tractor as incorrect operation can cause substantial mechanical damage as well as cause accidents with the associated injuries.**

Please note that in some cases differences can exist between this manual and your tractor due to the manufacture's policy of constant product improvement.

In the event that you strike a problem not covered by this manual, please contact your nearest dealer who will assist you in resolving your problem.







**WARNING**

**CALIFORNIA Proposition 65 Warning**

**The Engine Exhaust from this product contains chemicals known to the State of California to cause cancer, birth defects or other reproductive harm.**

## WARNING SIGNS IN THIS MANUAL

The following warning symbols in this manual draw additional attention to items of importance for the safe and correct operation of the tractor.

SIGN	MEANING OF THE SIGN
 DANGER	Serious hazard with a very high level of risk of either serious injury or death.
 WARNING	Hazard or unsafe practice that can lead to severe injury or death.
 CAUTION	Hazard or unsafe practice that can lead in injury or death.
 IMPORTANT	Instructions for the correct operation of the machine which, if followed, will ensure that it performs at its best.

All information, illustrations and specifications in this manual are based on latest information available at the time of publication. The right is reserved to make changes at any time without notice.

**SAFETY**



1

**GENERAL INFORMATION**



2

**OPERATION**



3

**MAINTENANCE AND SERVICE**



4

**SPECIFICATION AND TIPS**



5

**INDEX**



6

## TABLE OF CONTENTS

### **SAFETY** **1**

1. SAFETY INSTRUCTIONS ..... 1-2
2. SAFE OPERATION OF THE TRACTOR ..... 1-10
3. DO'S AND DONT'S ..... 1-17
4. SAFETY SIGNS ..... 1-19
5. UNIVERSAL SYMBOLS ..... 1-22

### **GENERAL INFORMATION** **2**

1. ABOUT THIS MANUAL ..... 2-2
2. TRACTOR IDENTIFICATION ..... 2-3
3. INTRODUCTION & DESCRIPTION ..... 2-4
4. OWNER ASSISTANCE ..... 2-7
5. ROPS (Roll Over Protective Structures) ..... 2-8

### **OPERATION** **3**

1. INSTRUMENT PANEL AND CONTROLS .... 3-2
2. PRE-OPERATION CHECK ..... 3-9
3. OPERATING THE ENGINE..... 3-10
4. OPERATING THE TRACTOR ..... 3-15
5. PTO ..... 3-21
6. HYDRAULICS ..... 3-23
7. THREE-POINT HITCH AND DRAWBAR ... 3-27
8. CONNECTING AND DISCONNECTING  
IMPLEMENT ..... 3-31

### **MAINTENANCE AND SERVICE** **4**

1. MAINTENANCE AND ADJUSTMENT ..... 4-2
2. SERVICING ENGINE ..... 4-4
3. SERVICING TRANSMISSION ..... 4-12
4. SERVICING ELECTRICAL ..... 4-15
5. SERVICING ..... 4-17
6. STORAGE ..... 4-20
7. FUEL SAVING TIPS ..... 4-22
8. HOW TO USE OF JACK ..... 4-24
9. TROUBLESHOOTING ..... 4-25
10. TOWING THE TRACTOR ..... 4-28

### **SPECIFICATION AND TIPS** **5**

1. SPECIFICATION ..... 5-2
2. SPECIFICATION TABLE ..... 5-3
3. MASS AND TIRE ..... 5-4
4. NOISE LEVELS ..... 5-5
5. VIBRATION REFERRED TO THE  
OPERATOR POSITION ..... 5-6

### **INDEX** **6**

1. INDEX ..... 6-2

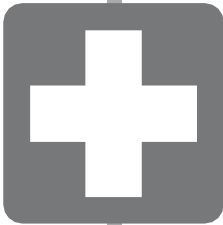

## **SAFETY**

- 1. SAFETY INSTRUCTIONS ..... 1-2**
- 2. SAFE OPERATION OF THE TRACTOR ..... 1-10**
- 3. DO'S AND DONT'S ..... 1-17**
- 4. SAFETY SIGNS ..... 1-19**
- 5. UNIVERSAL SYMBOLS ..... 1-22**

**1. SAFETY INSTRUCTIONS**

**RECOGNIZE SAFETY INFORMATION**

This symbol means **ATTENTION! YOUR SAFETY IS INVOLVED**. The message that follows the symbol contains important information about safety. Carefully read the message.



**SIGNAL WORDS.**

A signal word—**DANGER, WARNING OR CAUTION**—is used with safety alert symbol. **DANGER** identifies the most serious hazards. Safety signs with signal Word —**DANGER OR WARNING**—are typically near specific hazards. General precautions are listed on **CAUTION** safety signs.

**DANGER**



**WARNING**



**CAUTION**



**READ SAFETY INSTRUCTION**

Carefully read all safety instructions given in this manual for your safety. Tempering with any of the safety devices can cause serious injuries or death. Keep all safety signs in good condition. Replace missing or damaged safety signs.

Keep your tractor in proper condition and do not allow any unauthorized modifications to be carried out on the Tractor, which may impair the function/safety and affect Tractor life.

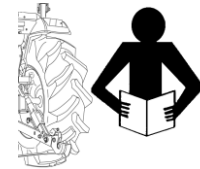

**PROTECTION CHILDREN**

Keep children and others away from the Tractor while operating.

**BEFORE YOU REVERSE**

- Look behind Tractor for children.
- Do not let children to ride on Tractor or any implement.



**USE OF ROPS AND SEAT BELT**

The Roll Over Protective Structure(ROPS) has been certified to industry and/or government standards. Any damage or alternation to the ROPS, mounting hard-ware, or seat belt voids the certification and will reduce or eliminate protection for the operator in the event of a roll-over. The ROPS, mounting hardware, and seat belt should be checked after the first 100 hours of Tractor and every 500 hours thereafter for any evidence of damage, wear or cracks. In the event of damage or alteration, the ROPS must be replaced prior to further operation of the Tractor.

The seat belt must be worn during machine operation when the machine is equipped with a certified ROPS.

Failure to do so will reduce or eliminate protection for the operator in the event of a roll over.

**PRECAUTION TO AVOID TIPPING**

Do not drive where the Tractor could slip or tip.

Stay alert for holes and rocks in the terrain, and other hidden hazards.

Slow down before you make a sharp turn.

Driving forward out of a ditch or mired condition could cause Tractor to tip over backward. Back out of these situations if possible.

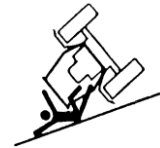
**PARK TRACTOR SAFELY**

Before leaving on the Tractor ;

Lower all equipment to the ground.

Stop the engine and remove the key.

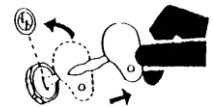
**KEEP RIDERS OFF TRACTOR**

Do not allow riders on the tractor.

Riders on Tractor are subject to injury such as being stuck by foreign objects and being thrown off of the tractor.



**HANDLE FUEL SAFELY-AVOID FIRES**

Handle fuel with care; it is highly flammable. Do not refuel the Tractor while smoking or near open flame or sparks. Always stop engine before refueling tractors.  
Always keep your tractor clean of accumulated grease, and debris. Always clean up spilled fuel.



**STAY CLEAR OF ROTATING SHAFTS**

Entanglement in rotating shaft can cause serious injury or death.  
Keep PTO shield in place at all times. Wear close fitting clothing. Stop the engine and be sure PTO drive is stopped before making adjustments, connections, or cleaning out PTO driven equipment.



**ALWAYS USE SAFETY LIGHTS AND DEVICES**

Use of hazard warning lights and turn signals are recommended when towing equipment on public roads unless prohibited by state or local regulations.  
Use slow moving vehicle (SMV) sign when driving on public road during both day & night time, unless prohibited by law.

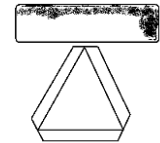

**PRACTICE SAFE MAINTENANCE**

- Understand service procedure before doing work.
- Keep the surrounding area of the Tractor clean and dry.
- Do not attempt to service Tractor when it is in motion.
- Keep body and clothing away from rotating shafts.
- Always lower equipment to the ground. Stop the engine.
- Remove the key. Allow Tractor to cool before any work repair is caused on it.
- Securely support any Tractor elements that must be raised for service work.
- Keep all parts in good condition and properly installed.
- Replace worn or broken parts. Replace damage/missing decals.
- Remove any buildup of grease or oil from the tractor.
- Disconnect battery ground cable(-) before making adjustments on electrical systems or welding on tractor.





**AVOID HIGH-PRESSURE FLUIDS**

Escaping fluid under pressure can penetrate the skin causing serious injury. Keep hands and body away from pinholes and nozzles, which eject fluids under high pressure. If ANY fluid is injected into the skin. Consult your doctor immediately.

**PREVENT BATTERY EXPLOSIONS**

Keep sparks, lighted matches, and open flame away from the top of battery. Battery gas can explode. Never check battery charge by placing a metal object across the poles.

**PREVENT ACID BURNS**

Sulfuric acid in battery electrolyte is poisonous. It is strong enough to burn skin, cause holes in clothing and cause blindness if found entry into eyes.

For adequate safety always;

1. Fill batteries in a well-ventilated area.
2. Wear eye protection and acid proof hand gloves
3. Avoid breathing direct fumes when electrolyte is added.
4. Do not add water to electrolyte as it may splash off causing severe burns.

If you spill acid on yourself;

1. Flush your skin with water.
2. Flush your eyes with water for 10-15 minutes.
3. Get medical attention immediately.

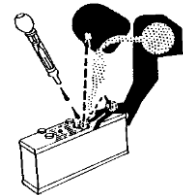
**BATTERY DISCONNECT**

1. When working with your tractors electrical components you must first disconnect the battery cables.
2. To ensure that there are no accidents from sparks you must first disconnect the negative battery cable.

**SERVICE TRACTOR SAFELY**

Do not wear a necktie, scarf or loose clothing when you work near moving parts. If these items were to get caught, severe injury could result.

Remove rings and other jeweler to prevent electrical shorts and entanglement in moving parts.



**WORK IN VENTILATED AREA**

Do not start the Tractor in an enclosed building unless the doors & windows are open for proper ventilation, as tractor fumes can cause sickness or death. If it is necessary to run an engine in an enclosed area remove the exhaust fumes by connecting exhaust pipe extension.



**TRACTOR RUNAWAY**

The tractor can start even if the transmission is engaged position causing Tractor to runaway and serious injury to the people standing nearby the tractor.  
For additional safety keep the transmission in neutral position, Foot brake engaged and PTO lever in disengaged position while attending to Safety Starter Switch or any other work on tractor.



To avoid injury, always engage park brake, ensure HST is in neutral position and PTO switch is off when starting or running the engine.

**SAFETY PRECAUTIONS WHEN USING THE LOADER**

Never let anyone get in the loader and use the loader as a workbench.  
Otherwise, it may lead to a fatal injury or even death.



**SAFETY PRECAUTIONS WHEN USING THE LOADER**

Do not stand under the lifted loader or get close to it. Also, lower the loader arm onto the ground before leaving the tractor.  
Otherwise, it may lead to a fatal injury or even death.



**SAFETY PRECAUTIONS WHEN USING THE LOADER**

When attaching or detaching the loader, fix all parts which are connected to the bucket and boom.  
The bucket or boom can be accidentally dropped down, leading to an injury or even death.

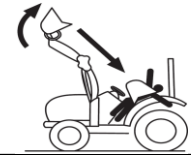
**IMPORTANT****SAFETY PRECAUTIONS WHEN USING THE LOADER**

ROPS (Roll Over Protective Structure), sun canopy or cabin are not a FOPS (Falling Object Protective Structure).

It never can protect the riders against falling objects. Avoid driving the vehicle into a dangerous area such as falling rocks zone.

**SAFETY PRECAUTIONS WHEN USING THE LOADER**

Do not allow loader arms or attachment to contact electrical power lines.  
Electrocution will cause serious injury or death.

**SAFETY PRECAUTIONS WHEN USING THE LOADER**

Never carry a big object with the loader unless a proper implement is attached. Keep a carried object low during driving.  
Otherwise, it may lead to an injury or even death.

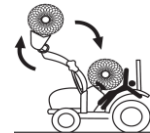
**SAFETY PRECAUTIONS WHEN USING THE LOADER**

When attaching or detaching the loader, fix all parts which are connected to the bucket and boom.  
The bucket or boom can be accidentally dropped down, leading to an injury or even death.



### TOWING SAFELY

For the maximum towable loads, refer to the paragraph " Maximum towable loads in the Technical Data Section.

- Maintain a suitable speed taking into account the weight of the trailed load and the gradient, remembering that braking distances will be greater than with just the tractor.

Trailed loads with or without brakes that are too heavy for the tractor or that towed at too high speed may cause the operator to loose of control of the tractor.

- Always take into consideration the total weight of the implements and their loads.

- When trailers are hitched to the tractor, before you leave the operator seat remember to put all the controls in neutral, apply the handbrake, switch off the engine, engage first gear (with mechanical transmissions) and remove the ignition key.

ALWAYS chock both the tractor and the trailer wheels. The best way to transport a tractor that has broken down is to transport it on a low loader. Always secure the tractor to the loader bed with chains.

Before transporting the tractor on a low loader or on a railway wagon, make sure that the engine hood, doors, open able roof (if present) and windows are all closed and securely fastened.

Never tow the tractor at speeds in excess of 10 kph. An operator must stay in the operator position to steer and brake the tractor.



#### CAUTION

When a trailers is hitched to the tractor, before you leave the driving seat remember to put all the controls in neutral, apply the handbrake, switch off the engine, engage first gear (if the tractor has a mechanical transmission) and remove the key from the starter switch.

If the tractor is not parked on level ground, ALWAYS place chocks under the wheels of both the tractor and the trailer.

For further information on safe working procedures, refer to the chapter "Parking the tractor" in the safe section of this manual.

### OPERATOR PROTECTIVE STRUCTURE(OPS)

The term OPS refers to a protective structure installed on a tractor in order to minimize risk of operator injury caused by objects penetrating into the operator position area.



DANGER

This tractor is not equipped with an OPS. If work must be performed in areas subject to the risk of the penetration of objects into the operator position, consult your dealer before starting work so that the tractor can be equipped with an appropriate protective structure.

### USE OF HAZARDOUS SUBSTANCES

**The classification category, as stipulated by ISO 14269-5, of the cab installed on this range of tractors is given below:**

- the engine operating at nominal speed.
- the maximum quantity of air drawn from outside the cab (recirculation closed).
- with fan at maximum speed.

The manufacturer of your tractor has made every effort to make it as safe as is humanly possible.

Beyond this point it is the responsibility of the operator to avoid accidents and we ask that you read and implement our suggestions for your safety.

Ensure that only trained and competent operators use this tractor and ensure that they are fully conversant with the machine and aware of all its control and safety features.

Operators should not operate the tractor or associated machinery while tired or untrained. To avoid accidents please ensure that the operator wears clothing which will not get entangled in the moving parts of the tractor or machine and protect him or her from the elements.

When spraying or using chemicals, please ensure that clothing and protective equipment is worn which prevents respiratory or skin problems.

For full details consult the manufacturer of the chemicals.

To avoid lengthy exposure to noise ensure that ear protection is worn.

If adjustment to the tractor or machinery need to be made ensure the tractor or machine are turned off beforehand.

Use of certified Roll Over Protection Structure (ROPS) is a must while operating a tractor.

Use of seat belt is a must while operating a tractor.

In summary, ensure at all times that the safety of the operator and any other worker is paramount.

Ensure no one is between the tractor and a towed vehicle (trailer or implement).

## 2. SAFE OPERATION OF THE TRACTOR

The manufacturer of your tractor has made every effort to make it as safe as is humanly possible.

Beyond this point it is the responsibility of the operator to avoid accidents and we ask that you read and implement our suggestions for your safety.

**Ensure that only trained and competent operators use this tractor and ensure that they are fully conversant with the machine and aware of all its control and safety features.**

Operators should not operate the tractor or associated machinery while tired or untrained.

To avoid accidents please ensure that the operator wears clothing which will not get entangled in the moving parts of the tractor or machine and protect him or her from the elements.

When spraying or using chemicals, please ensure that clothing and protective equipment is worn which prevents respiratory or skin problems.

For full details consult the manufacturer of the chemicals.

To avoid lengthy exposure to noise ensure that ear protection is worn.

If adjustment to the tractor or machinery need to be made ensure the tractor or machine are turned off beforehand.

Use of certified Roll Over Protection Structure (ROPS) is a must while operating a tractor.

Use of seat belt is a must while operating a tractor.

In summary, ensure at all times that the safety of the operator and any other worker is paramount.

### **SAFETY TIPS DURING MAINTENANCE**

1. At least on a daily basis check all oil levels.  
Water level in the radiator and electrolyte level in the battery and perform services according to the service schedule.
2. Ensure tire pressure are even and the correct pressure for the job being done is maintained.
3. Check to ensure that the all controls and preventative mechanisms of the Tractor and implement work correctly and effectively.
4. Ensure that an adequate set of the correct tools is available for maintenance and minor repairs.
5. Ensure that all service work and repairs are carried out on a flat area with a concrete or similar floor.  
Do not carry out service work on a tractor until it is switched off, and the parking brake applied and wheels chocked.  
Where a tractor is started in a confined area, ensure that the area is well ventilated as exhaust gases are very harmful, and can cause death.
6. Do not work under raised implements.
7. When changing wheels or tires ensure that a suitable wheel stand is placed under the axle prior to removing the wheel and the wheels are chocked.
8. Where guards or shields need to be removed to perform a service or repair, ensure that the guard or shield is correctly reinstalled before starting the Tractor.
9. Never refuel near a naked flame or with an overheated engine. Ensure to turn off Engine before refueling.
10. The cooling system operates under pressure, take care when removing the Radiator cap on a hot engine to prevent being scalded by steam or hot water.  
Do not add water in the radiator when the engine is hot.  
Add water to the radiator only after the engine cools down completely.
11. To prevent fires keep the tractor including the engine clean and free from inflammable material and well away from fuels and other inflammable material.



### **MOUNTING AND DEMOUNTING IMPLEMENTS**

- 1) Ensure that all mounting and removal of implements is done on safe flat ground.  
Ensure no one is between the Tractor and implement and do not get under the implement to avoid accidental injuries.
- 2) After mounting the implement, ensure that all sway chains are correctly adjusted and, where PTO shafts are used that the shaft is fitted and secured correctly.
- 3) Where heavy implements are used, ensure that the combination is well balanced or use proper ballast to achieve balance.
- 4) Before leaving the tractor at any time, lower the implement, stop the PTO shaft where applicable, set the parking brake and switch off the engine.
- 5) While operating the implements with the PTO keep all bystanders away from any moving parts and do not attempt to make adjustments while the machine is running.
- 6) Only the driver should ride on the Tractor with the ROPS frame fitted and with the seat belt properly fastened.
- 7) Where young children are present, particular care should be taken and the tractor should not be moved until the whereabouts of all children is known.
- 8) Only trained operators should operate the Tractor and so taking care to ensure that other workers are not injured. In particular they should take care during dusty operations, which will reduce visibility substantially.
- 9) Never start the tractor unless the transmission is out of gear, the operator is in the seat and all round safety has been checked.
- 10) Only operate the tractor seated in the drivers seat and never turn or brake suddenly at high speed as this can cause a roll-over and serious injury or death.
- 11) When traveling on a public road ensure that the tractor and driver both meet all laws relating to safety and licensing. When traveling with wide implements use red flags on the extremities and observe all legal including escort requirements.
- 12) When operating under adverse conditions, hilly terrain or on bad ground adjust the speed of the tractor to suit the conditions, safety comes first. Never drive down hill at high speed or with the transmission in neutral. Use of the braking capacity of the engine as well as the service brakes. Do not try to change gear going up or down a steep slope, select the correct gear before starting.
- 13) Take care when traveling uphill with a heavy implement to ensure that it does not overbalance and tip up the front end.
- 14) Never remove or modify the seat belt.
- 15) Never remove, modify or repair the ROPS frame.

**PLEASE REMEMBER THAT A LITTLE BIT OF EXTRA CARE CAN PREVENT SERIOUS INJURY OR TEATH AND AVOID DAMAGE TO YOUR TRACTOR.**



## **THE PRECAUTION TO HELP PREVENT ACCIDENTS**

**A careful operator is the best operator.**

**Most accidents can be avoided by observing certain precautions.**

**Read and take the following precautions before operating the Tractor to prevent accidents.**

**Tractor should be operated only by those who are responsible and properly trained to do so.**

### **■ The Tractor**

1. Read the operator's manual carefully before using the tractor. Lack of operating knowledge can lead to accidents.
2. Use an approved rollover bar and seat belt for safe operation. Overturning of a tractor without a rollover bar can result in death or injury.
3. **Do not remove ROPS (Roll Over Protective Structure).** Always use the seat belt.
4. Fiberglass canopy does not give any protection.
5. To prevent falls, keep steps and platform clear of mud and oil.
6. Do not permit anyone but the operator to ride on the Tractor. There is no safety place for extra riders.
7. Replace all missing, illegible or damaged safety signs.

### **8. Keep safety signs clean of dirt and grease.**

### **■ Servicing the Tractor**

1. Keep the tractor in good operating condition for your safety. An improperly maintained Tractor can be hazardous.
2. Stop the engine before performing any service on the tractor.
3. The cooling system operates under pressure, which is controlled by the radiator cap.

**It is dangerous to remove the cap while the system is hot.**

First turn the cap slowly to stop and allow the pressure to escape before removing the cap entirely.



## SAFETY

---

4. **Do not smoke while the refueling the tractor. Keep away any type of open flame.**
5. The fuel in the injection system is under high pressure and can penetrate the skin. Unqualified persons should not remove or attempt to adjust a pump, injector, nozzle or any part of the fuel injection system. Failure to follow these instructions can result in serious injury.
6. **Keep open flame away from battery or cold weather starting aids to prevent fire or explosions.**
7. **Do not modify or alter or permit anyone else to modify or alter this tractor or any of its components or any tractor functions.**

### ■ Operating the tractor

1. Before starting the tractor apply the parking brake, place the PTO (Power Take Off) lever in the "OFF" position, the hydraulic control levers in the downward position, the remote control valve levers in the neutral position if fitted) and the transmission in neutral.
2. Do not start the engine or controls while standing besides the tractor. Always sit on the tractor seat when the engine or operating controls.
3. Safety starter switch.

**In order to prevent the accidental starting of the tractor, a safety switch has been provided.** The starting system of the tractor is connected through this switch, which becomes operative only when the break pedal is depressed.

All models SUB shifter lever and PTO button should also be in neutral position for completing the starting circuit.

### **Do not bypass the safety starter switch.**

Consult your TYM Tractor Dealer/Distributor if safety- starting switch malfunctions.

4. Avoid accidental contact with the gear shifter lever while the engine is running. Unexpected Tractor movement can result from such contact.
5. Do not get off or climb the tractor while it is in motion.
6. Shut off the engine, remove the key and apply the parking brake before getting off the tractor.
7. Do not operate the tractor in an enclosed building without adequate ventilation. Exhaust fumes can cause death.

8. Do not park the tractor on a steep slope.
9. **If power steering or Engine seizes to operate, stop the tractor immediately.**
10. Pull only from the swinging draw bar or the lower link drawbar in the down position. Use only a drawbar pin that locks in place. Pulling from the tractor rear axle carriers or any point above the rear axle may cause the Tractor's front end to lift.
8. If the front end of the tractor tends to rise when heavy implements are attached to the three-point linkage, install front end or front wheel weights. Do not operate the tractor with a light front end.
8. Always use hydraulic position control lever when attaching equipments/implement and when transporting equipment. Be sure that the hydraulic couplers are properly mounted and will disconnect safely in case of accidental detachment of implement.
8. Do not leave equipment/implement in the raised position.
9. Use the flasher/ Turn signal lights and Slow Moving Vehicle (SMV) signs when driving on public roads during both day and night time, unless prohibited by law.
8. Dim tractor lights when meeting a vehicle at night.  
Be sure the lights are adjusted to prevent the blinding on the eyes of coming vehicle operator.

#### ■ Driving the tractor

1. Watch where you are going especially at row ends, on roads, around trees and low hanging obstacles.
2. To avoid upsets, drive the tractor with care and at speeds compatible with safety, especially when operating over rough ground, crossing ditches or slopes, and when turning at corners.
3. Lock the tractor brake pedals together when transporting on roads to provide proper wheel braking.
4. Keep the tractor in the same gear when going downhill as used when going uphill. Do not coast or free wheel down hills.
5. Any towed vehicle and/or trailer whose total weight exceeds that of the towing Tractor, must be equipped with its own brakes for safe operation.
6. When the tractor is stuck or tires are frozen to the ground, back out to prevent upset.
7. Always check overhead clearance, especially when transporting the tractor.



### ■ Operating the PTO (Power Take Off)

1. When operating PTO driven equipment, shut off the engine and wait until the PTO stops before getting off the tractor and disconnecting the equipment.
2. Do not wear loose clothing when operating the power take-off or near rotating equipment.
3. When operating stationary PTO driven equipment, always apply the tractor parking brake and block the rear wheels from front and rear side.
4. To avoid injury, always move down flip part of PTO. Do not clean, adjust or service PTO driven equipment when the tractor engine is running.
5. Make sure the PTO master shield is installed at all times and always replace the PTO shield cap When the PTO is not in use.

### ■ Diesel Fuel

1. Keep the equipment clean and properly maintained.
2. Under no circumstances should gasoline, alcohol or blended fuels be added to diesel fire or explosive hazard. Such blends are more explosive than pure gasoline. In a closed container, such as a fuel tank. **DO NOT USE THESE BLENDS.**
3. Never remove the fuel cap or refuel the tractor with the engine running.
4. Do not smoke while refueling or when standing near fuel.
5. Maintain control of the fuel filler pipe when filling the tank.
6. Do not fill the fuel tank to capacity. Allow room for expansion.
7. Wipe up spilled fuel immediately.
8. Always tighten the fuel cap securely.
9. If the original fuel tank cap is lost, replace it with genuine cap. A none approved cap may not be safe.
10. Do not drive equipment near open fire.
11. Never use fuel for cleaning purpose.
12. Arrange fuel purchases so that winter grade fuel are not held over and used in the spring.

**N.B: It is suggested that after repairs if any of the safety decal/sign is peeled/defaced, the same may be replaced immediately in interest of your safety.**

### 3. DO'S AND DON'T'S

#### DO'S-For Better performance



- DO** – Ensure that safety shields are in place and in good condition.
- DO** – Read all operating instructions before commencing to operate Tractor.
- DO** – Carry out all maintenance tasks without fail.
- DO** – Keep the air cleaner clean.
- DO** – Ensure that the correct grade of lubricating oils is used and that they are replenished and changed at the recommended intervals.
- DO** – Fit new sealing rings when the filter elements are changed.
- DO** – Watch the oil pressure gauge or warning light and investigate any abnormality immediately.
- DO** – Keep the radiator filled with clean water and in cold weather use anti-freeze mixture. Drain the system only in an emergency and fill before starting the engine.
- DO** – Ensure that the transmission is in neutral before starting the engine.
- DO** – Keep all fuel in clean storage and use a filter when filling the tank.
- DO** – Attend to minor adjustments and repairs as soon as necessity is apparent.
- DO** – Allow the engine to cool before removing the radiator filler cap and adding water, remove the radiator cap slowly.
- DO** – Shift into low gear when driving down steep hills.
- DO** – Latch the brake pedals together when driving on a highway.
- DO** – Keep draft control lever fully down when not in use.

**DON'Ts-For safe operation**

- DON'T** – Run the engine with the air cleaner disconnected.
- DON'T** – Start the tractor in an enclosed building unless the doors and windows are open for proper ventilation.
- DON'T** – Operate the tractor or engine while lubricating or cleaning.
- DON'T** – Allow the tractor to run out of diesel fuel otherwise it will be necessary to vent the system.
- DON'T** – Temper the fuel injection pump, If seal is broken the warranty becomes void.
- DON'T** – Allow the engine to run idle for a long period.
- DON'T** – Run the engine if it is not firing on all cylinders.
- DON'T** – Ride the brake pedal. This will result in excessive wear of the brake lining.
- DON'T** – Use the independent brakes for making turns on the highway or at high speeds.
- DON'T** – Refuel the tractor with the engine running.
- DON'T** – Mount or dismount from the right side of the tractor.
- DON'T** – Temper the hydraulic control levers' upper limit stops.
- DON'T** – Use draft control lever for lifting of implements.
- DON'T** – Start the engine with the PTO engaged.
- DON'T** – Use the governor Control Lever (Hand throttle) while driving on roads.
- DON'T** – Move the hydraulic levers rearward.

## 4. SAFETY SIGNS

### GENERAL SAFETY INFORMATION



**IMPORTANT**

This “General safety Information” should be kept with the machine at all times as reference data.



**CAUTION**

This symbol means ATTENTION! YOUR SAFETY IS INVOLVED.

The message that follows the symbol contains important information about safety. Follow recommended precautions and safe operating practice.

### DECALS MOUNTING LOCATION

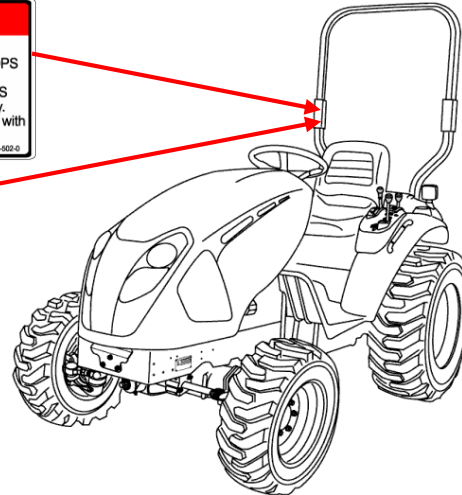

**DECALS MOUNTING LOCATION**

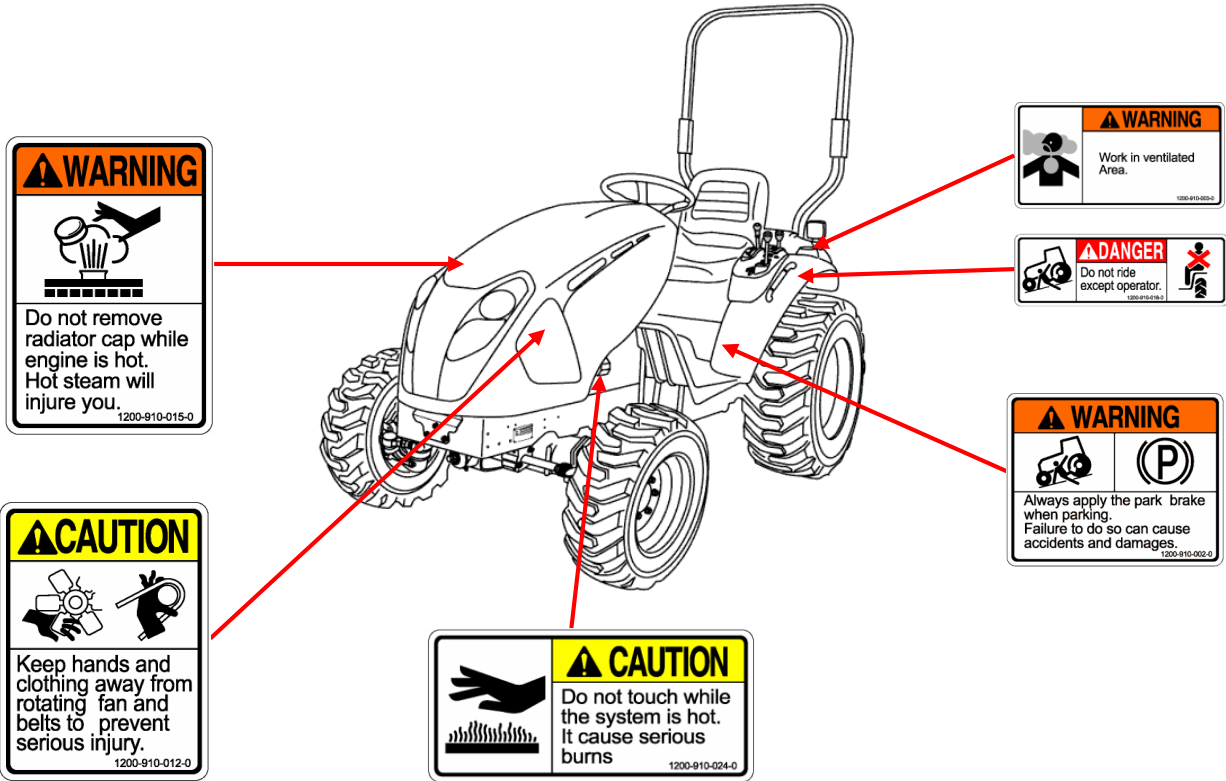



**DECALS MOUNTING LOCATION**

**PARKING BRAKE**

Press down the master brake pedal and lock the parking lever at the same time

1472-904-013-0

**WARNING**



Never use the diff lock at high speed or on the road as this can cause rollover and injury.

1200-910-006-0



1768-020-005-0

**WARNING**



Always set the knob to lock when

- 1.Travelling on the road.
- 2.Replacing blades on an implement
- 3.Making adjustment to an implement

Sudden dropping of an implement can cause serious injury or death.

1200-910-004-0

**WARNING**



Do not refuel the tractor while smoking or near naked flame or sparks, always stop engine before refueling tractors.

1200-910-005-0

**WARNING**



Brake pedals must always be locked together when travelling on the highway. This will ensure uniform braking and provide maximum stopping ability sharp turns must only be made at slow speeds.

1200-910-007-0

**WARNING**



Attach implements and trailers to the tractor only using the prescribed drawbar or hitch.

1200-910-014-0

**ANGER**



Rotating driveline contact can cause death. KEEP AWAY! Keep all drive line. Tractor and equipment shields in place during operation.

1200-910-002-0

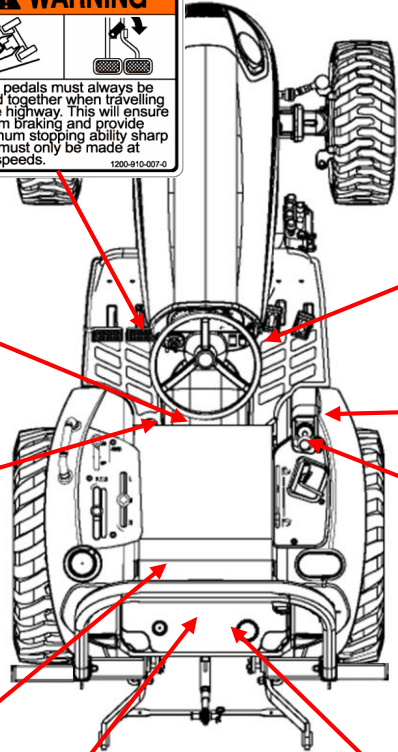

**WARNING**



Operator's manual

1200-910-023-0

**WARNING**



Always fasten your seat belt.

1200-910-019-0

**WARNING**



















1768-910-017-0

This ROPS frame was tested in accordance with OECD Standard (Code 7) (Equivalent to AS 1636.2) for use on Tong-Yang(TYM) tractor models T233, T273 and T293 with a maximum weight(GVM) of 900kg. Manufactured by HAN-SUNG Co, KOREA Test station : NATIONAL INSTITUTE OF AGRICULTURAL ENGINEERING, KOREA

1815-910-002-0

## 5. UNIVERSAL SYMBOLS

Some of the universal symbols have been shown below with an indication of their meaning

Engine speed (rev/minX100)		Pressured-open slowly		Corrosive substance	
Hours, recorded		Continuous variable		Slow or minimum Setting	
Engine coolant temperature		Warning		fast or maximum setting	
Fuel level		Hazard warning		Transmission oil pressure	
Engine Stop control		Neutral		Turn signal	
Lights		Fan		Transmission oil temperature	
Horn		Power take off engaged		Parking brake	
Engine oil pressure		Power take off disengaged		Head lamp	
Air filter		Lift arm/raise		Differential lock	
Battery charge		Lift arm/lower		See operator's manual	



## **GENERAL INFORMATION**

- 1. ABOUT THIS MANUAL ..... 2-2**
- 2. TRACTOR IDENTIFICATION ..... 2-3**
- 3. INTRODUCTION & DESCRIPTION ..... 2-4**
- 4. OWNER ASSISTANCE ..... 2-7**
- 5. ROPS (Roll Over Protective Structures) ..... 2-8**



### 1. ABOUT THIS MANUAL

This manual has been prepared to assist you in following/adopting the correct procedure for running-in operation and maintenance of your new TYM Tractor.

Your Tractor has been designed and built to give maximum performance, with good fuel economy and ease of operation under a wide variety of operating conditions.

Prior to delivery, The tractor was carefully inspected, both at the factory and by your TYM Dealer/Distributor, to ensure that it reaches you in optimum conditions.

To maintain this condition and ensure trouble free performance.

It is important that the routine services, as specified in this manual, are carried out at the recommended intervals.

Read this Manual carefully and keep it in a convenient place for future reference.

If at any time you require advice concerning your Tractor, do not hesitate to contact your Authorized TYM dealer/Distributor.

He has trained personnel, genuine parts and necessary equipment to undertake all your service requirements.

TYM.CO., LTD. Policy is one of continuous improvement, and the right to change prices, specifications or equipment at any time without notice is reserved.

All data given in this book is subject to production variations.

Dimensions & weight are approximate only and the illustrations do not necessarily show Tractors in standard condition.

For exact information about any particular Tractor, please consult your TYM dealer/Distributor.



## 2. TRACTOR IDENTIFICATION

The tractor serial number is shown on the left hand side of the tractor as shown in the picture.

The engine number is stamped on the top of the engine block.

Engine type and number on the top of Engine body

Manufacturer's tractor Sr. No.  
Stamped on plate on the L.H.S  
of axle bracket

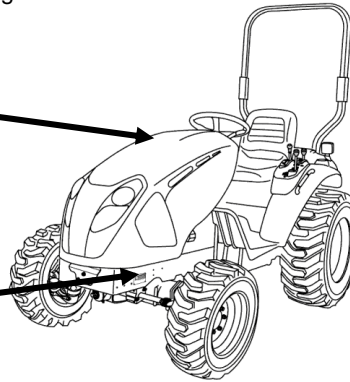

### **WARRANTY OF THE PRODUCT**

The manufacturer warrants this product and full details of the warranty are provided on a separate warranty schedule.

### **SERVICE**

Service is available from any TYM dealer in the country.

### **PARTS**

To obtain spare parts please contact your nearest dealer and give him the details listed below.

Tractor model

Tractor serial number

Tractor engine number

Part number and description

Quantity required.



### 3. INTRODUCTION & DESCRIPTION

#### TRACTOR AN INTRODUCTION

The word, 'Tractor' has been derived from 'Traction' which means pulling.

A Tractor is required to pull or haul an equipment, implement or trolley which are coupled to the Tractor body through suitable linkage.

A Tractor can also be used as a prime mover as it has a power outlet source which is also called Power Take or PTO shaft.

In this book the operating, maintenance and storage instructions for all models of TYM Diesel Tractors has been compiled.

This material has been prepared in detail to help you in the better understanding of maintenance and efficient operation of the machine.

If you need any information not given in this manual, or require the services of a trained mechanic, please get in touch with the TYM Dealer/Distributor in your locality.

Dealer/Distributors are kept informed of the latest methods of servicing Tractors.

They stock genuine spare parts and are backed by the company's full support.

Through this manual.

The use of the terms **LEFT, RIGHT, FRONT and REAR** must be understood, to avoid any confusion when following the introductions.

The **LEFT** and **RIGHT** means left and right sides of the Tractor when facing forward in the driver's seat, Reference to the **FRONT** indicates the radiator end of the Tractor, while the **REAR**, indicates the drawbar end (Illustration E)

When spare parts are required, always specify the Tractor and engine serial number when ordering these parts.

This will facilitate faster delivery and help ensure that the correct parts for your particular Tractor is received.

The tractor serial number is punched on a plate attached to the left hand side of the engine body, For easy reference, we suggest you to write the number in the space provided in the owner's personal data.

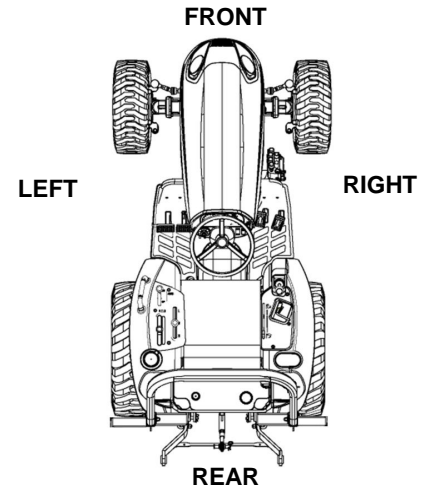

**Illustration E**  
( Front, Rear, Left, Right Position)



## **DESCRIPTION**

### **■ General construction**

The transmission case, Engine and Front Axle Support are bolted together to form a rigid unit.

### **■ Front Axle & Wheels**

The 4WD front axle is a center-pivot, reverse Eliot type.

The front wheel drive mechanism is incorporated as a part of the axle.

The front wheel drive power is taken off the rear transmission and transmitted to the differential in the front axle where the power is divided into right and left and to the respective final cases.

In the final cases, the transmitted revolution is reduced by the level gears to drive the front wheel.

The 4WD mechanism with level gears provides wider steering and greater durability.

### **■ Engine**

The tractors are fitted with vertical, Water-cooled 4-cycle.

### **■ Transmission with HST(Hydrostatic Transmission)**

The tractor is fitted HST with two range and can be selected speed range by HIGH- LOW selector lever. The tractor has two pedals for forward/reverse control.

Tractor with Independent Power Take Off is fitted with electro-hydraulic clutch assy.

The Rear PTO and Mid PTO can be operated both or separately by a lever.

### **■ Brakes**

TYM tractors are provided with independent disc brakes operated by two road travel.

A foot brake lever is fitted for parking.



## GENERAL INFORMATION

---

### ■ Rear axle & Wheels

This is mounted on ball bearings and is enclosed in removable housing which are bolted to the transmission case.

The rim & Disc fitted with Rear tires are bolted to the outer flange of Rear Axle.

### ■ Hydraulic system & Linkages.

TYM Tractors are fitted with Live (i.e. system is in operation.) independent, very touch of hydraulic system.

Three point Linkages can be used for category 1 type of implements.

### ■ Steering

It consists of Hydrostatic Power steering system, which has a hydraulic cylinder and single type hydraulic pump.

### ■ Electrical System

A 12 Volt Lead Acid Propylene Battery is used to activate the Engine through the Starter Motor and the Electrical system comprising Horn, Head Lamp.

Side indicator Lamps, Plough Lamp, Brake Light, Gauge lamp, Hazard Lamp. Generator or Alternator, Fuse box also from part of the Electrical system.





### 3. OWNER ASSISTANCE

We at TYM.CO.,LTD. and TYM Dealer/Distributor wants you to be completely satisfied with your investment.

Normally any problems with your equipment will be handled by your Dealer/Distributor's Service Departments, however, misunderstanding can occur.

If you feel that your problem has not been handled to your satisfaction, we suggest the following.

Contact the owner or General Manager of the Dealership, explain the problem, and request assistance. When additional assistance is needed, Your Dealer/Distributor has direct access to your office.

If you cannot obtain satisfaction by doing this, contact the TYM CO.,LTD. Office and provide them with;

- **Your name, address and telephone number**
- **Model and Tractor serial number**
- **Dealer/Distributor Name & Address**
- **Machine purchase date and Hours used**
- **Nature of problem**

Before contacting TYM.CO.,LTD. office, be aware that your problem will likely to be resolved in the Dealership using the Dealer's/Distributor's facilities, equipment and personnel.

So it is important that your initial contact be with the Dealer/Distributor.



### 4. ROPS (Roll Over Protective Structures)

TYM CO.,LTD tractors are fitted with a frame for the protection of operators of tractors to minimize the possibility of serious operator injury result from accidental upset.

These are called as ROPS and are characterized by providing space for the clearance zone inside the envelope of the structure or within a space bounded by a series of straight lines from the outer edge of the tractor to any part of the Tractor that might come in contact with flat ground and is capable of supporting the Tractor in that position if the Tractor overturns.

The mounting structure and fasteners forming the mounting connection with the Tractor are part of the ROPS.



**CAUTION**

Loosen and release the knob slowly and cautiously to fold down the ROPS.

If Tractor is operated with ROPS folded (E.g. to enter a low building) Drive with extreme caution and do not use seat belt. Fold the ROPS up again before the Tractor is operated under normal conditions.

Please note that in no condition. The tractor is to be operated without ROPS. Operating the tractor without ROPS, with folded.

**ROPS with damaged ROPS or hardware can lead to fatal injuries.**

#### **ROPS MAINTENANCE AND INSPECTION**

The ROPS has been certified to industry and/or government standards.

Any damage or alteration to the ROPS, mounting hardware or seat belt voids the certification and will reduce or eliminate protection for the operator, in the event of a roll-over.

The ROPS, mounting hardware and seat belt should be checked after the first 100 hrs. of machine operation and every 500 hrs thereafter for any evidence of damage wear or cracks.

In the event of damage or alteration the ROPS must be replaced prior to further operation of the machine.

The seat belt must be worn during machine operation when it is equipped with a certified ROPS.

Failure to do so will reduce or eliminate protection of the operate in the event of a roll-over.

Substitution of mounting hardware, seat belt etc. with components not equal to or superior to the original certified components will void the certification and will reduce or eliminate protection for the operator in the event of a roll-over.



**DAMAGE OF THE ROPS**



If the tractor has rolled over or the ROPS has damaged (such as striking an overhead object during transport), It must be replaced to provide the original protection.

After an accident, check for damages to the 1. ROPS, 2. Seat, 3. seat belt & seat mountings.

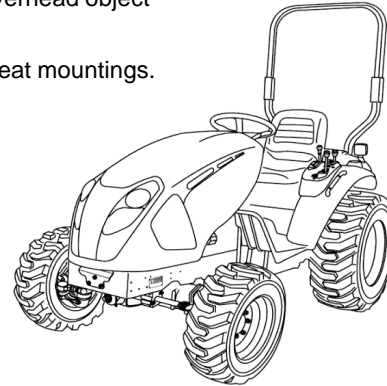
Before you operate a Tractor, replace all damaged parts.



**DO NOT WELD, DRILL OR STRAIGHTEN THE ROPS**

 WARNING	Never attach chains, ropes to the ROPS for pulling purposes; this will cause the Tractor to tip backwards. Always pull from the Tractor drawbar. Be careful when driving through door opening or under low overhead objects. Make sure there is sufficient overhead clearance for the ROPS fatal injuries.
 WARNING	If the ROPS is removed or replaced, make certain that the proper hardware is used to replace the ROPS and the recommended torque values are applied to the attaching bolts.
 WARNING	Always wear your seat belt if the tractor is equipped with ROPS.



## GENERAL INFORMATION

### FOR SLIDING SEAT

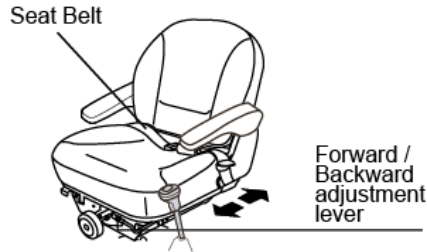

#### **NOTE**

Do not use solvents to clean the seat. Use warm water with a little detergent added. Before operating a Tractor it is important to adjust the seat to the most comfortable position & check whether it is properly locked in its position.

Figure 1 identifies the seat fitted to your Tractor.

 <b>CAUTION</b>	<p>Do not put a hand between the seat and the slides when adjusting the seat position. You can get injured unexpectedly.</p>
---	--

To select Seat position, move Adjusting lever and slide Seat closer to or away from Dash panel and controls.

 <b>DANGER</b>	<p>Check whether the seat properly locked in its position before driving the tractor.</p>
--	---

 <b>DANGER</b>	<p>Always use the seat belt when the ROPS is installed.          Do not use the seat belt if a foldable ROPS is down or there is no ROPS.          Check the seat belt regularly and replace if frayed or damaged.</p>
--	--



## CUSHION STRENGTH ADJUSTMENT

2

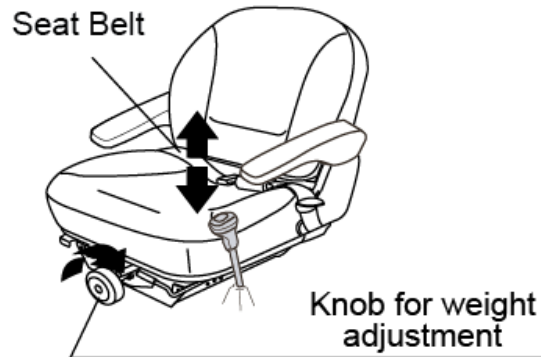

The seat cushion can be adjusted according to the weight of the driver. Turning the cushion adjustment lever counterclockwise to the 50kg position makes the cushion lighter, and turning the lever clockwise to the 130kg position makes the cushion heavier.



## GENERAL INFORMATION

---

### MEMO

A series of horizontal dotted lines for writing a memo.

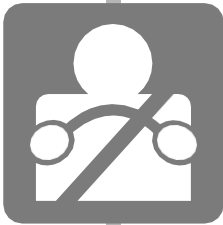

## **OPERATION**

- 1. INSTRUMENT PANEL AND CONTROLS .... 3-2**
- 2. PRE OPERATION CHECK ..... 3-9**
- 3. OPERATING THE ENGINE ..... 3-10**
- 4. OPERATING THE TRACTOR ..... 3-15**
- 5. PTO ..... 3-21**
- 6. HYDRAULICS ..... 3-23**
- 7. THREE-POINT HITCH AND DRAWBAR .... 3-27**
- 8. CONNECTING AND DISCONNECTING  
IMPLEMENT SYMBOLS ..... 3-31**

## 1. INSTRUMENT PANEL AND CONTROLS

### SWITCHES AND GAUGES

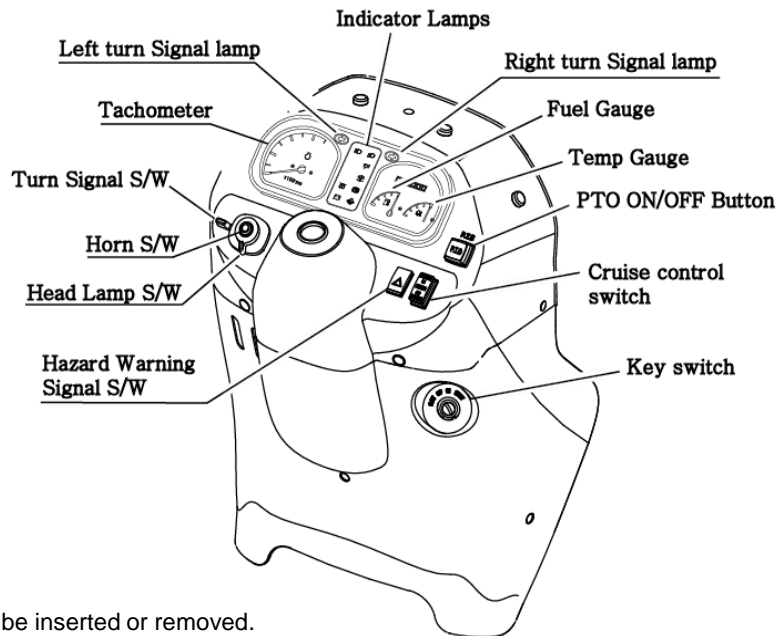

#### ① KEY SWITCH

- 『OFF』 — The key can be inserted or removed.
- 『ON』 — The electric circuit is on.
- 『GLOW』 — Glow plugs pre-heat the combustion chamber.
- 『START』 — The starter motor is engaged.

When the key is released it will automatically return to the 『ON』 position.

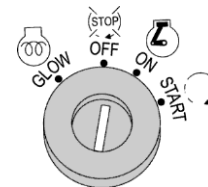





## ② COOLANT TEMPERATURE GAUGE

The gauge shows the coolant temperature with the key switch ON.

C is low to normal temperature and H is high temperature.

If the pointer is in the red H segment, the engine is overheating.

Refer this book to rectify the problem.

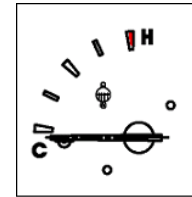

## ③ TACHO METER

This meter shows the revolutions of the engine and the PTO shafts as well as the travel speed in top gear.

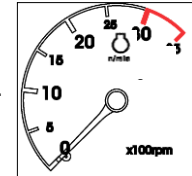

## ④ HOUR METER

The hour meter consists of digits with the last digit indicating 1/10th of an hour.

It shows hours the tractor has been used.

The lamp at bottom of hour meter should twinkle during operation.



## ⑤ FUEL GAUGE

Shows the amount of fuel in the fuel tank when the key switch is ON.

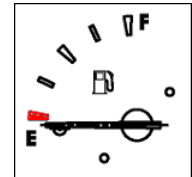

## ⑥ LIGHT SWITCH, INDICATORS AND HORN

Head lamp is operated on the main switch.

When indicator is pulled down, left turn signal turns ON and flash.

When indicator is pushed up, right turn signal turns ON and flash.

When the horn button is pressed, the horn will sound.

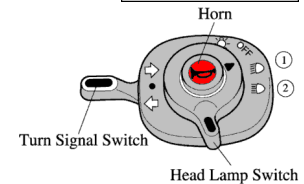

### ⑦ HAZARD WARNING LIGHT SWITCH

When the switch is pushed once, the hazard warning lights(left and right turn signal) are ON and flash.

When the switch is pushed again, the hazard lights are OFF.

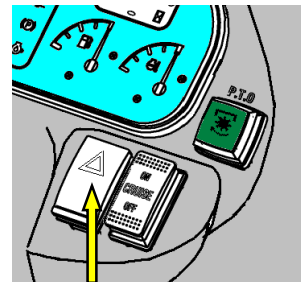

**HAZARD WARNING LIGHT SWITCH**

### ⑧ CRUISE CONTROL SWITCH

When the switch is pushed ON Position, the cruise control is engaged and the switch light and indicator lamp on instrument panel are ON.

When the switch is pushed OFF Position or brake pedal is depressed, the cruise control and the lights are OFF.

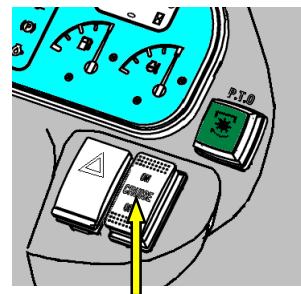

**CRUISE CONTROL SWITCH**

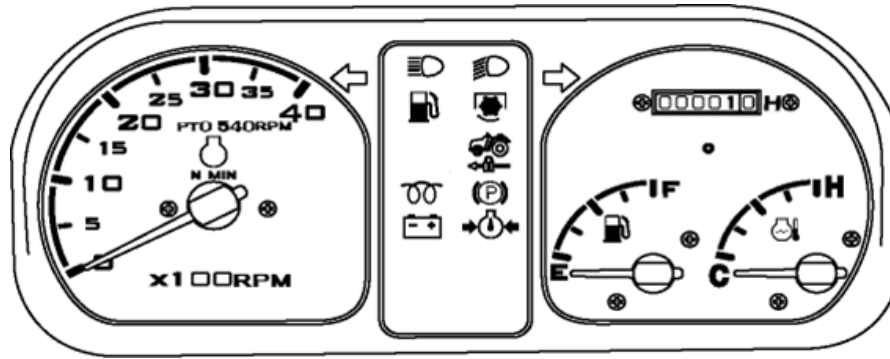
**INDICATOR LAMPS**

## ① High beam lamp

This lamp is operated on the combination switch .



## ② Low beam lamp

This lamp is operated on the combination switch



## ③ PTO Monitor Lamp

This lamp will turn on when PTO is engaged.



## ④ Cruise Control Lamp

This lamp will turn on when cruise control is engaged.



## ⑤ Fuel Empty Warning Lamp

This lamp shows warning that the fuel in fuel tank goes empty.

If this lamp comes on, Fill the tank with fuel.



⑥ Charge lamp

This lamp will go off as soon as the engine starts to run to indicate that the alternator is charging (Please note, as broken fan belt can cause the light to come on, please stop the engine as overheating can occur if not rectified immediately).



⑦ Glow signal Lamp

This lamp indicates pre-heating.



⑧ Turn Signal Lamp

These lamps are used to indicate operator's turn direction.

When indicator is pulled down, left turn signal turns ON and flashes.

When indicator is pushed up, right turn signal turns ON and flashes.

These lamps will turn on and flash when hazard warning switch is pushed.



⑤ Oil pressure lamp

This lamp will go out as soon as the engine starts if the oil pressure is correct.

If it comes on while the engine is running, stop the engine and get expert advice.



⑨ Coolant temperature warning lamp

This comes on when engine is overheated.



⑩ Parking brake lamp

This comes on when parking brake is engaged.



## **INDEPENDENT PTO**

### **■ PTO Monitor Lamp**

On the dash panel indicates the state of the PTO shaft.

1. If the monitor glows: The PTO is On.
2. If the monitor is off: The PTO is off.



PTO Monitor Lamp

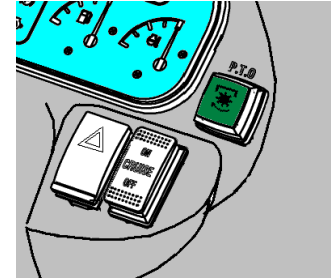

### **■ PTO ON/OFF Switch**

PTO ON/OFF switch is situated on the right hand side on the instrument panel and can be identified easily with its built in green colored indicator.

When the switch is pushed down to start the PTO indicator glows to indicate that the switch and the PTO are in ON position.

If the switch is pushed down again the indicator goes off signaling that the PTO is OFF.

**The PTO shaft will not rotate if switch is in OFF position.**

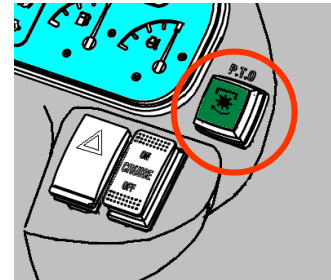

PTO ON/OFF Switch

**TRACTOR CONTROLS**

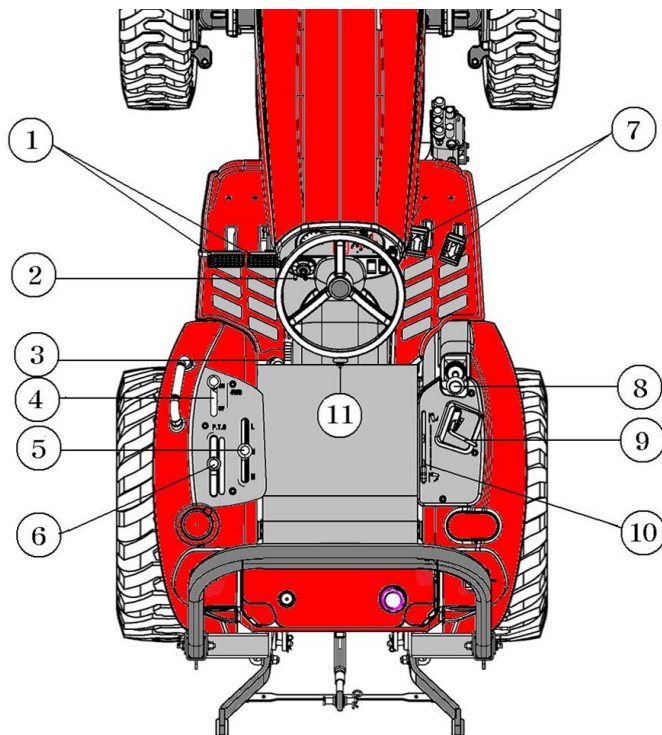

- ① Turn Brake Pedals
- ④ Front Wheel Drive(4WD) Lever
- ⑦ Speed Control Pedals
- ⑩ Position Control Lever

- ② Parking Brake Lever
- ⑤ Range Shift Lever
- ⑧ Joy stick Lever
- ⑪ Lowering Speed Control knob

- ③ Differential Lock Pedal
- ⑥ PTO Lever
- ⑨ Hand Throttle Lever



## 2. PRE-OPERATION CHECK

To avoid problems, it is recommended that a range of checks be carried out daily before starting the tractor.

For details of the items and period, please refer to the maintenance table.

1. Check all shields and guards. Be sure they are in place.
2. Check the engine coolant level. Add if required.
3. Check the engine oil level. Add if required.
4. Check the transmission oil level. Add if required.
5. Check the tire pressure. Adjust if required.
6. Check the fuel level with key switch ON position. Refuel if required.
7. Check the operation of all gauges, switches, lights, indicators and horn.
8. Check the brake pedals. Adjust if required.
9. Check the speed control pedals.
10. Check the seat belt and ROPS.



CAUTION

To avoid injury, always ensure that the tractor is on level place with the engine stop and the parking brake is engaged before check.

### 3. OPERATING THE ENGINE

#### STARTING THE ENGINE

1. Sit on the operator seat. Adjust seat and seat belt.

##### ■ Adjusting Operator Seat

It is important to adjust the seat to the most comfortable position.

- ① Lift the adjust lever at the front of the seat.
- ② Slide the seat forward or backward to desired position.
- ③ Release the lever. Then the seat will lock automatically in position.

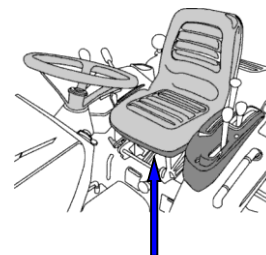

**Seat Adjusting Lever**



CAUTION

To avoid injury, always use the seat belt when the tractor is equipped with ROPS.  
Do not use the seat belt if the ROPS is removed.



CAUTION

To avoid injury, ensure that the steering wheel is locked before operating the tractor.

2. Make sure that all levers are in their neutral position - the range shift lever, the rear PTO lever, mid PTO lever and front wheel drive lever.

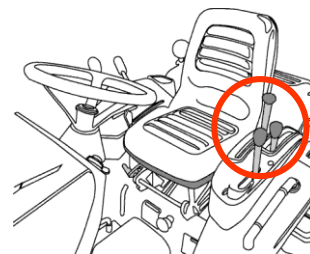





3. Push the hydraulic lever in the down position.
4. Pull the hand throttle lever to about 1/3-1/2 way.

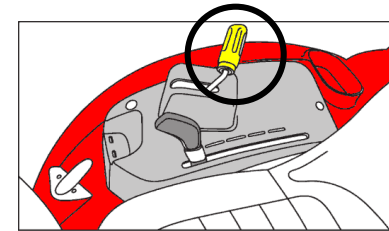
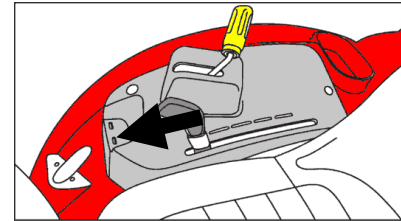

■ Hand Throttle Lever

The hand throttle lever is used to change engine speed.

Pushing the throttle lever toward the operator decreases engine speed.

Pulling it away from the operator increases engine speed.

5. Insert the key. Turn the key “ON” position. Do not start engine.
6. Make sure that the PTO switch is off.  
It is allowable that either of PTO is off.  
Refer to above independent PTO.

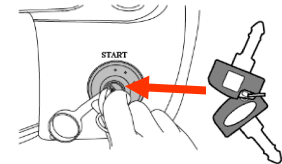

7. Ensure that the warning lights are working.

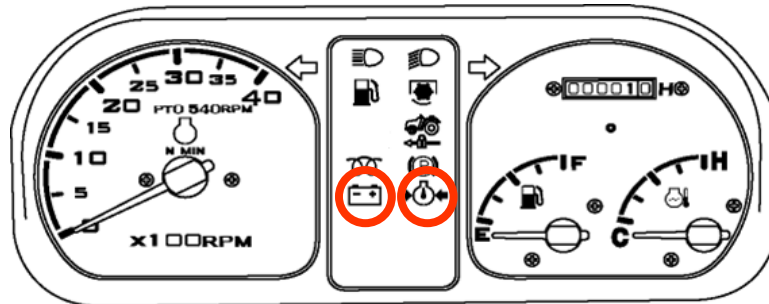



**IMPORTANT**

### ■ Safety Start Conditions

Engine will start only under conditions as follows;

- ① PTO switch is OFF.
- ② Brake is depressed or parking brake is engaged.
- ③ Transmission be in neutral position.

8. Depress the master brake pedal fully or make sure the parking brake is engaged.

### ■ Engaging Parking Brake

- ① Depress the brake fully.
  - ② Pull up the parking brake lever to engage.
  - ③ Depress the brake again to release the parking brake.
9. Turn the key to “START” position and release when the engine starts.
10. Ensure that all warning lights are off with the engine running.

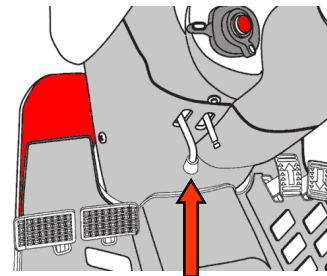

**IMPORTANT**

Never turn the key to the start position while the engine is running as this can cause serious damage to the starter and engine flywheel.

Only engage the starter for a period of not more than 10 seconds.

If Engine does not start, rest the starter for about 20 seconds and try again for a maximum of 10 seconds.

If the engine does not start after repeated attempts, refer to the troubleshooting guide.



**IMPORTANT**

Especially in cold weather, always allow the tractor to idle for a while to warm up and build up sufficient oil pressure to ensure normal operating temperature for longer engine life.



## **COLD WEATHER STARTING**

When the ambient temperature is below 23°F, the following step is to be used instead of step 10.

Turn the key to left to glow position for a moment and release it.

The automatic heater will start working as will be indicated by a light on the instrument panel.

As the lamp goes off, turn the key to the start position to start the engine.

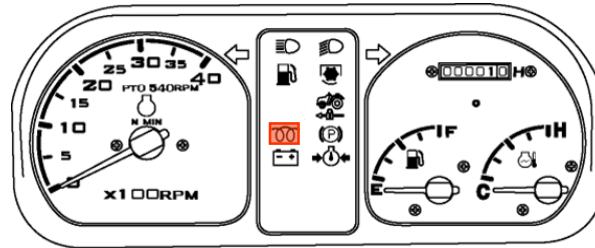

## **STOPPING THE ENGINE**

1. Let the engine idle for approximately 2 minutes and turn key switch to off position.
2. The engine stops when the key is turned off.
3. Remove key.



IMPORTANT

After long or heavy work allow the engine to idle for 5- 10 minutes and turn the key off.



IMPORTANT

If the engine does not stop by key, consult immediately your Dealer/Distributor.

### **WARMING UP**

When starting the engine allow it to warm up to operating temperature by allowing it to idle 5-10 minutes to ensure full lubrication and operating temperature.

Failure to do so can shorten engine life substantially.

#### **■ Warming up in Cold Weather**

Cold weather will change the viscosity of the oil, resulting in a reduced oil pumping capacity, which can cause damage to the engine if it is not warmed up correctly. It also causes problems with the hydraulic system and the synchromesh in the transmission.

Correct times for warming up are:

Temperature	Time for warming up
Above 50°F	5~10 min.
50°F ~ 32°F	10~20 min.
32°F ~ 14°F	20~30 min.
14°F ~ -4°F	30~40 min.
Below -4°F	Over 40 min.



**IMPORTANT**

Ensure the parking brake is on during the warming period.



## 4. OPERATING THE TRACTOR

When the engine warm up correctly, the tractor is prepared for operating.

### DRIVING

1. Make sure that all condition is ready.

Adjustments of the operator seat, the seat belt, and the steering wheel.

- Sufficient engine warm up.
- Fasten seat belt.

2. Raise the implement using the position control lever.

3. Select speed range with the range shift lever.

#### ■ Range Shift Lever

The range shift lever is used to select the speed range of tractor.

The lever can be shifted only when the tractor stops completely.

The lever is linear and has three positions, a neutral and two range gears.

A neutral is located between L and H range gear.

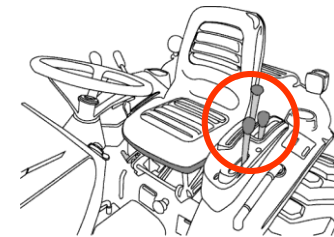
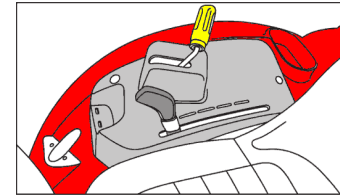

IMPORTANT

Do not operate the range shift lever without stopping the tractor.

4. Increase the engine speed with hand throttle.

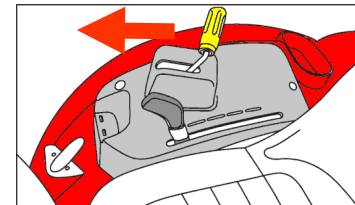



## OPERATION

5. Release the parking brake by depressing the brake.
6. Select the driving direction and depress speed control pedal.

### ■ Speed Control Pedals

Depress the forward speed control pedal to move forward.

Depress the reverse control pedal to move backward.

The speed control pedal will return in neutral position and the tractor will stop when the speed control pedal is released.

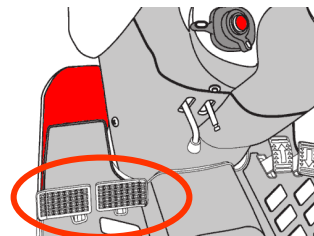

**Brake Pedals**

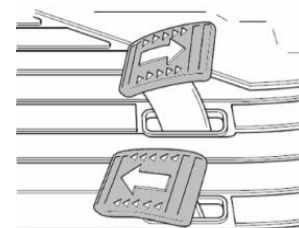

**Speed Control Pedals**



**IMPORTANT**

Do not change from forward to backward or backward to forward suddenly in high range. Sudden change may result in damage of mechanism and place the operator at risk of injury.

### **STOPPING AND PARKING**

1. Release speed control pedals.  
Depress the brake pedal to stop the tractor, if necessary.
2. Decrease the engine speed using hand throttle.
3. Move the range shift lever to neutral position.
4. Lower any implement to the ground.
5. Apply the parking brake.
6. Turn the key to OFF position to stop the engine.
7. Remove the key.



**CAUTION**

Always apply the parking brake when parking. Failure to do so can cause accidents and damage. As an extra precaution when parking on a slope, chock the rear wheels.



## CONTROLLING

### ■ Cruise Control

The cruise control function is provided for comfortable and efficient operation. When the cruise control is engaged, the cruise control lamp on instrument panel will turn on.

#### 1. Engaging the cruise control.

- ① Depress the forward speed control pedal till getting desired speed.
- ② Push the cruise control switch to engage cruise control.
- ③ Release the speed control pedal.

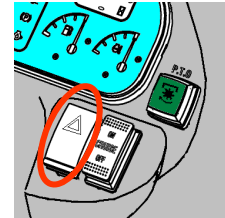

#### 2. Disengaging the cruise control

There are two methods to disengage the cruise control.

- ① Push cruise control switch "OFF" or,
- ② Depress the brake pedal.

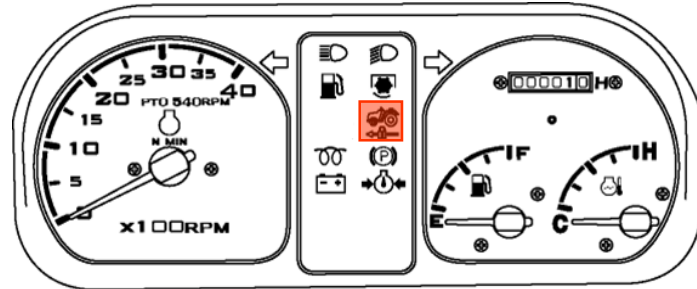

IMPORTANT

To avoid damage of mechanism, do not depress both of the speed control pedals when the cruise control is engaged.



CAUTION

To avoid personnel injury, do not use the cruise control in reverse.

■ **Diff-lock Pedal**

In case of wheel slippage ,use the diff-lock by pushing down on the diff lock pedal.

To release it remove the foot from the pedal.

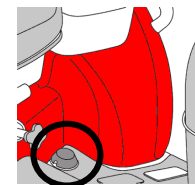

 DANGER	Tractor will be difficult to turn if the Diff-lock is engaged, ensure the lock is disengaged before turning the steering wheel.
---	---

 IMPORTANT	Do not use high engine speed when engaging differential lock. If the differential lock does not release after removing the foot from the differential lock pedal alternatively brake with the left and right turn brake until it gets released.
--	--

 CAUTION	Never use the differential lock at high speed or on the road as this can cause roll over and injury.
--	--

■ **Front Wheel Drive(4WD)**

The front wheel drive is used to increase traction performance greatly by engaging the front wheel.

The front wheel drive can be engaged when the tractor is stopped.

**In the ON position of the front wheel drive lever, the front wheels are engaged and in the OFF position, they are disengaged.**

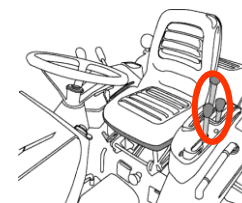

 CAUTION	Do not use front wheel drive at high speed or on the road as premature wear of components will result.
--	--





### ■ Light Turns in the Field

To make a tight turn at low speed, use both the steering wheel and the turn brake pedal at the same time. For left turn, use the left turn brake pedal and for right turn, use the right turn brake pedal.

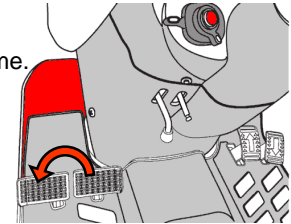

CAUTION

Perform tight turns only at a slow safe speed.

Doing so at a high speed can cause rollovers and very serious injury or death.



WARNING

Do not use the turn brake pedals for high speed or road use.

In the interest of safety always use it on the road or at high speed as using one side only can cause rollovers.

**When servicing the tractor ensure that the adjustment on both sides is the same.**

### ■ Uphill Start on a Steep Slope

1. Depress the brake pedal.
2. Set the range shift lever to Low and the hand throttle to medium engine speed.
3. Release the brake pedal.
4. Depress the speed control pedal slowly.
5. Adjust the hand throttle to the desired speed .

### ■ Driving Downhill

Use the engine's ability to brake when traveling downhill.

Never rely on the brakes only and never travel downhill with the gears in neutral.



CAUTION

When operating in hilly terrain the risk of the rollover is increased substantially, please drive with extra care.

When towing trailers in hilly terrain ensure that they are equipped with brakes, use a lower gear to get maximum engine braking and do not change gears on a down hill run.

### **CHECK DURING DRIVING**

Constantly monitor the warning lamps on the instrument panel and if any comes on stop the tractor to determine the cause.

If the oil pressure lamp turns on, check the oil level first of all.

If the oil level is OK ask a qualified dealer to check the reason for the light coming on.

If the charge lamp turns on, check all connections and ensure that the fan belt is not broken.

If all connections and the fan belt are intact, consult your dealer to determine the cause of the problem.

#### ■ **Fuel Gauge**

To avoid excessive condensation in the fuel tank, refill at the end of each day's work and ensure during the day that it does not drop to a low level where the fuel system will require bleeding to expel air in the system after refilling the tank.



#### ■ **Engine Coolant Warning Lamp**

If the gauge indicates that the engine is running hot, stop the tractor and check the coolant in the radiator.



 <b>DANGER</b>	<p>Allow the engine to cool down before opening radiator cap as serious burns may result due to hot steam &amp; boiling water.</p>
--	--

Also check to ensure that the fins in the radiator core are not clogged or that the tractor has a broken or stretched fan belt.

 <b>CAUTION</b>	<p>When traveling on public or farm roads connect both brake pedals and allow for the weight of any mounted implement to ensure that the unit is not unbalanced.</p> <p>Also allow for the width when passing other road users.</p> <p>Where fitted use the hazard lights provided.</p> <p>Strictly follow the local traffic regulations.</p>
---	---

 <b>CAUTION</b>	<p>When operating near others with an implement attached take particular care to allow for the width of the implement and avoid accidents.</p>
---	--



## 5. PTO (Power Take Off)

Both of the rear and mid PTO are provided for variable utility.

They can be engaged simultaneously or separately at same time.

The engine will not start if PTO switch is ON position.



CAUTION

**To avoid damage of transmission and implement, do not engage PTO with the engine running at high speed.**

3

### REAR PTO

The tractor has one speed PTO(560rpm). Use the PTO lever to engage.

The PTO switch must be OFF before PTO is engaged.

1. Decrease engine speed to near idle.
2. Make sure that PTO switch is OFF.
3. Engage rear PTO using the PTO lever.
4. Turn on the PTO switch.
5. Increase engine speed to desired speed.

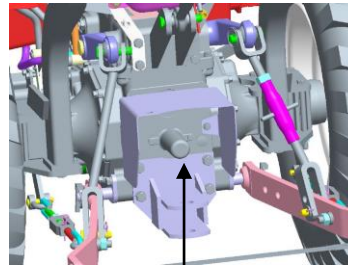

PTO safety cover

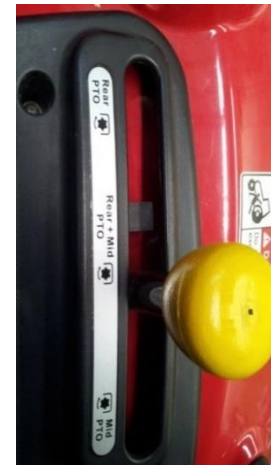

## OPERATION

### **MID PTO(OPTIONAL)**

The speed of mid PTO is 2,110rpm. Use the PTO lever to engage.

The PTO switch must be OFF before PTO is engaged.

1. Decrease engine speed to near idle.
2. Make sure that PTO switch is OFF.
3. Engage mid PTO using the PTO lever.
4. If rear PTO is needed to engage, shift the PTO lever to correct position.
5. Turn on the PTO switch.
6. Increase engine speed to desired speed.

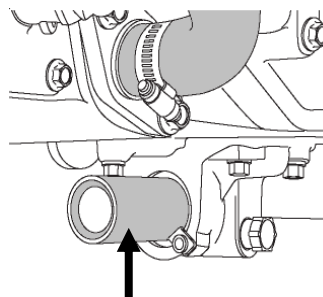

**Mid PTO safety  
cover**



**Mid**

**Mid +  
Rear**

**Rear**



**IMPORTANT**

If operator turns off PTO switch, rear PTO and mid PTO are off at once.



**CAUTION**

Do not operate any implement at a high speed than is specified for it.  
When making adjustments to the implement stop the engine to avoid serious injury.  
When leaving the tractor stop the engine, and remove the key.  
Set the parking brake.



## 6. HYDRAULICS

The hydraulics are powered with an engine driven hydraulic pump and controlled with a position control lever mounted beside the driver.

### **POSITION CONTROL**

Implements can be raised and lowered with the hydraulic position control lever and can be stopped at any position by stopping the lever.

To ensure a consistent working depth the adjustable stop can be set to ensure that the implement returns to the same depth every time.

To raise the implement : Pull the lever back

To lower the implement : Push the lever forward

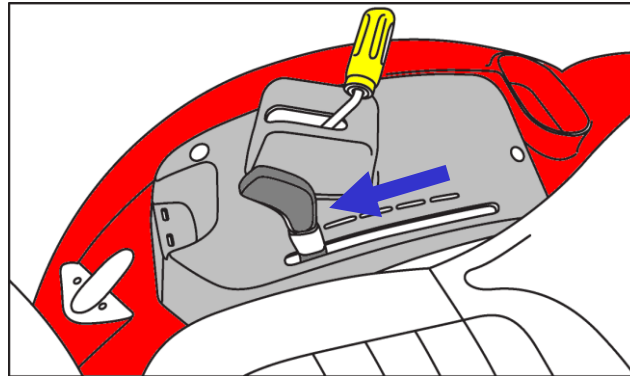

CAUTION

After finishing the work, always lower the implement to the ground and switch off the engine. Set the parking brake to avoid injuries and accidents.



CAUTION

When working with the 3-point linkage, keep well clear of the operating radius of the lift arms and any attached implement.

This is to avoid the risk of injury in the case of incorrect maneuvers.

### LOWERING SPEED CONTROL

To adjust the lowering speed for three point hitch, use the lowering speed control knob.

The knob controls the downward speed of the hydraulics three point hitch and is positioned at the front of the operator seat.

To slow the downward speed- Turn the knob clockwise

To increase the downward speed, turn the knob anticlockwise.

To lock, turn the knob clockwise.

Do not over tighten the knob.

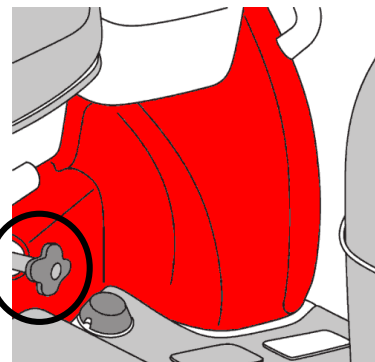
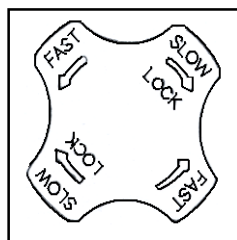

**CAUTION**

Always set the knob to lock when

1. Traveling on the road.
2. Replacing tires or blades on an implement.
3. Making adjustments to an implement.

Sudden dropping of an implement due to hydraulic problems can cause serious injury or death.



## HYDRAULIC OUTLET

The tractor is equipped the hydraulic outlet for attaching the hydraulically driven implement such as front end loader. The hydraulic outlet is located on right hand side of transmission.

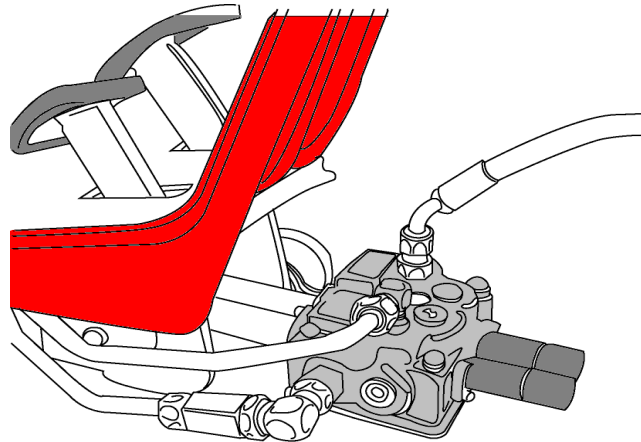

### ■ Installing the Loader

1. Connect the front end loader hoses to ports of loader control valve(A1, B1, A2, and B2).
2. A1 and B1 ports are used for lift/lowering/floating functions (inner side).
3. A2 and B2 ports are used for bucket/regenerative functions (outer side).

### ■ Detaching the Loader

1. Lock the joystick lever with the lever front of joystick.
2. Detach the hydraulic hoses of loader.
3. Assemble the steel cap (PF-3/8) on valve.

### HYDRAULIC REMOTE CONTROL VALVE (OPTIONAL)

The hydraulic remote control valve can be equipped as option.

The valve is used when attaching the implement operated by hydraulic cylinder.

The outlets have male threaded .

Use the remote control lever to operate implement. Move the lever up or down to control implement.

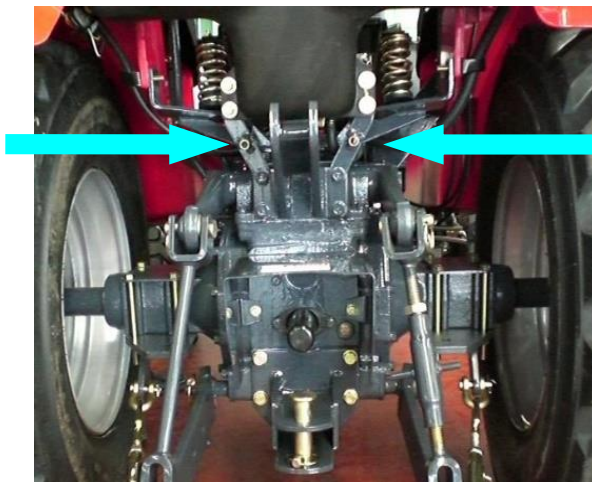

**CAUTION**

Make sure that Remote Control Valve Lever should be in neutral position.

In that case, do not use the remote control valve.

Failure to follow this instruction can result in serious damage of hydraulic components and engine.





## 7. THREE-POINT HITCH AND DRAWBAR

### OPERATING 3-POINT LINKAGE

TOP LINK

LOWER LINK

PTO SHAFT

CHECK  
CHAIN

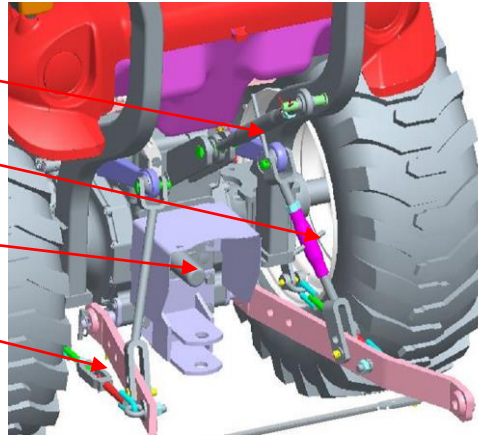

#### ► ADJUSTING THE TOP LINK

To adjust the check chain, turn the turnbuckle to lengthen or shorten the chain and tighten the lock nut when the correct adjustment is achieved.

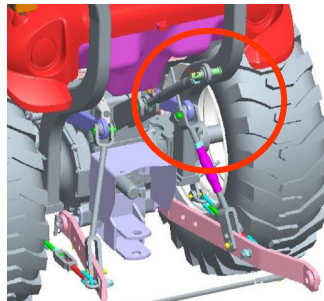

#### ► ADJUSTMENT OF THE CHECK CHAIN

Lengthening or shortening the top link will change the angle of the implement.

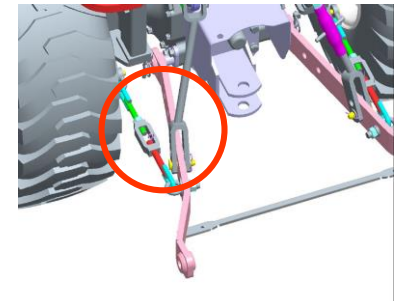

### ■ Adjustment of the Lower Link

The adjustment is done with the adjusting handle on the right hand yoke rod.

To shorten or lengthen the yoke rod turn the adjusting handle.

When adjusted correctly tighten the lock nut securely.

### ■ Adjustment of the Yoke Rod on the Lower Link

For different applications change the position of the yoke rod on the lower link holes as shown and insert the pin in the direction of the arrow

### ■ Use of the Retention Rubber

When not using implements on the three point linkage use the rubber as shown to prevent tire damage.

### ■ Mounting Implement

If the PTO is used, remove the safety cover off the PTO shaft.

Adjust the yoke rod on the lower links to suit the implement in use.

Attach the left lower link, then attach the right lower link using the adjusting handle on the leveling box if required.

Attach the top link.

Attach the PTO shaft to the tractor if used, making sure that it is locked in place.

Adjust the check chains to suit the implement and tighten the locknuts.

To remove an implement reverses the procedure.

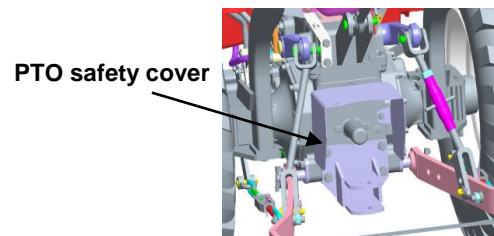
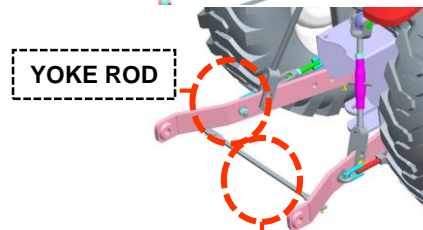
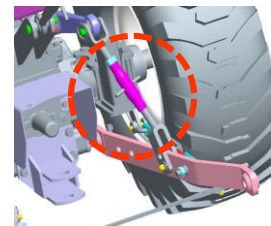

Do not attach a PTO shaft with the engine running and ensure all safety shields are in place.



## TOWING DEVICES



DANGER

Only use trailer hitch to tow and keep the 3 point linkage in raised position when towing with the drawbar. Position can create unbalance causing the Tractor to roll-over & Result the death or serious injury.



WARNING

All the implements mounted on the tractor must be secured firmly and in accordance with the manufacturer's instructions; see attachment holes diagram. Use permitted devices only.

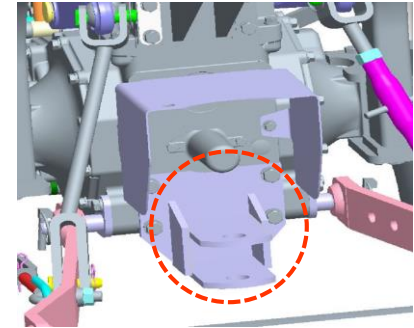

WARNING

The front towing hitch should be used for emergency trailer towing or for towing the tractor in the yard or in an authorized service center.



CAUTION

Never tow semi-mounted implements, trailers or agricultural machines by attaching them to the top link of the three-point linkage. This could cause the tractor to rear up or overturn backwards.



WARNING

When towing, always secure the hitch pin with a suitable lock pin with safety clip to prevent the hitch pin coming out the hitch. The lock pin must always be secured to the hitch.

## OPERATION

 <b>WARNING</b>	<p>The maximum permissible hitch load (horizontal and vertical), the maximum Permissible hitch height for road.</p> <p>Use and the maximum trailed load are indicated in the tractor registration document.</p>
---	---

 <b>CAUTION</b>	<p>Do not allow anyone to ride on the drawbar or the lower links when the tractor is in motion.</p>
---	---

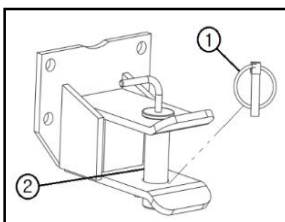

### Implement hitching and unhitching

To hitch an implement to the drawbar, proceed as follows

- Remove lock pin ①
- Remove pin ②
- Reverse the tractor slowly up to the implement
- Insert pin ②
- Insert lock pin ①

Drawbar Type	Maximum Horizontal load	Maximum Vertical load	Rear Tire
T-CC1	6613 lbs.	661 lbs.	9.5-20, 8PR (Ag) 36x13.5-15, 4PR(Turf) 12-16.5, 6PR(Ind)

### Technically permissible towable masses

Unbraked towable mass	1102 lbs.
Inertia-braked towable mass	6613 lbs.
Towable mass when fitted with hydraulic or pneumatic braking	N/A

### Tractor identification plate

The tractor serial number is stamped on aluminum plate locates on the LH side of the axle frame.



## 8. CONNECTING AND DISCONNECTING IMPLEMENT

### **CONNECTION**

- 1) Make sure to stop the engine before connecting it.
- 2) Move the double acting valve lever forward and backward for 4 to 5 times to release the pressure in the hydraulic line of the tractor. Otherwise, it is hard to connect the couplers, and hydraulic fluid can be sprayed from the line and get in to your eyes while connecting them.
- 3) Remove any foreign material around the male and female couplers. If foreign material enters the hydraulic components, it can lead to malfunction of the system.
- 4) Open the dust-proof cover of the female coupler of the tractor and insert the male coupler of the implement. A clicking sound is heard when the couplers are engaged.
- 5) Pull the hydraulic hose of the implement to check that the couplers are properly connected.
- 6) Start the engine and check the operating status and leakage.

### **DISCONNECTION**

- 1) Make sure to stop the engine before disconnecting it.
- 2) Release any residual pressure in the hydraulic hoses of the implement and tractor by operating the double acting valve lever 4 to 5 times.
- 3) Remove any foreign material around the couplers.
- 4) Keep the implement balanced by removing any load applied (lowering it onto the ground, for example). If disconnecting the hose while outer load is applied to the implement, it is hard to connect the implement in the future.
- 5) Remove the male coupler by pushing the female coupler boss of the tractor backward.
- 6) Close the dust-proof cover of the female coupler of the tractor. Wrap the male coupler of the implement with a plastic bag to prevent contamination.



**WARNING**

- Never connect or disconnect the implement hydraulic hose while the pressure in it is not released or the engine is running. It is hard to connect and disconnect the hose and hydraulic fluid can be sprayed from the hose, and get into your eyes or skin.
- Stop the engine and wear protective glasses and gloves before work.



## OPERATION

### MOUNTING IMPLEMENT

If the PTO is used, remove the safety cover off the PTO shaft.

Adjust the yoke rod on the lower links to suit the implement in use.

Attach the left lower link, then attach the right lower link using the adjusting handle on the leveling box if required.

Attach the top link.

Attach the PTO shaft to the tractor if used, making sure that it is locked in place.

Adjust the check chains to suit the implement and tighten the locknuts.

To remove an implement reverses the procedure.

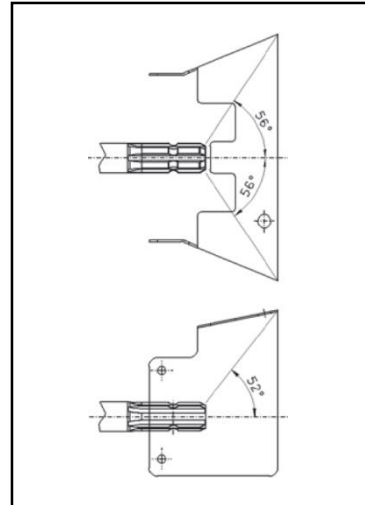
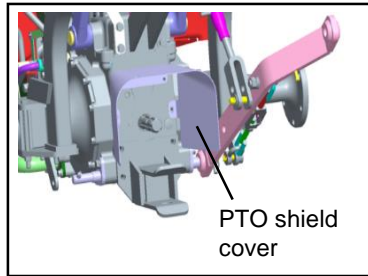

CAUTION

Do not attach a PTO shaft with the engine running and ensure all safety shields are in place.



## **MAINTENANCE AND SERVICE**

- 1. MAINTENANCE AND ADJUSTMENT ..... 4-2**
- 2. SERVICING ENGINE ..... 4-4**
- 3. SERVICING TRANSMISSION ..... 4-12**
- 4. SERVICING ELECTRICAL ..... 4-15**
- 5. SERVICING MISCELLANEOUS ..... 4-17**
- 6. STORAGE ..... 4-20**
- 7. FUEL SAVING ..... 4-22**
- 8. HOW TO USE OF JACKS ..... 4-24**
- 9. TROUBLESHOOTING ..... 4-25**
- 10. TOWING THE TRACTOR ..... 4-28**



# MAINTENANCE AND SERVICE

## 1. MAINTENANCE AND ADJUSTMENT

### PERIODICAL CHECK AND SERVICE TABLE

○Check, Top-up or adjust ●Replacement △Clean or wash ★First Replacement

Division	Item	Daily	Service interval(hour meter, mark)														Comment
			50	100	150	200	250	300	350	400	450	500	550	600	1 Year	2 Year	
Engine	Engine oil & Cartridge	○	★					●					●		●		Every 250 hours or 12 months after 1 <sup>st</sup> 50 hours
	Air cleaner					○						●					
	Radiator coolant	○														●	
	Fuel	○															Fill tank
	Fuel filter	○										●					
	Fan belt	○															
	Battery			○													
	Loose nuts and bolts	○															Tighten
	Radiator hose clamp	○															Tighten if required
Chassis	Transmission oil & HST Oil Filter		★					●					●		●		Every 250 hours or 12 months after 1 <sup>st</sup> 50 hours
	Front axle oil		★					●					●		●		
	Strainer		△						△								
	State of both brake pedals	○															
	Operation of each lever	○															Smooth operation
	Free play of steering wheel	○															About 50mm(1.97in) of wheel circumference
	Toe-in							○							○		





Division	Item	Daily	Service interval(hour meter,mark)														Comment
			50	100	150	200	250	300	350	400	450	500	550	600	1 Year	2 Year	
Chassis	Grease in front wheel hub							○									
	Check the steering wheel joint							○						○			
	Wheel nut fastening torque	○															
	Loose bolts and nuts	○															Tighten to proper torque
	Operation of the instrument	○															
	Grease each nipple		○	○	○	○	○	○	○	○	○	○	○	○			
	Oil of the 4WD front axle		★					○						●		●	
	Check the electric wiring	○															Loose or broken terminals, missing wiring. Check correctly clamped
	Hydraulic hoses & pipes							○									

## LUBRICATION CHART

No.	Filling point	Fillings	Capacity (US gal.)
1	RADIATOR	Fresh clean Water(L.L.C)	1.48
2	ENGINE	API : CF or CH-4 grades , Above:25°C...SAE30 or 10W-30 0°C to 25°C...SAE20 or 10W30 , Below 0°C...SAE 10W or 10W30	1.14
3	TRANSMISSION CASE	Tractor Hydraulic Fluids - API GL-4 Grade - Below -20°C ISO VG 32, Above -20°C ISO VG 46	5.81
4	FRONT AXLE	Gear Oils - API GL-4 Grade, SAE 80W/90	1.19
5	FUEL TANK	Diesel fuel	6.6

### \* Recommended Transmission Oil

- ① RPM Tractor Hydraulic Fluid or Textron TDH Premium (CALTEX) ② TDH Oil or TDH Oil special (TEXACO) ③ Chevron 1000THF (CHEVRON)



## 2. SERVICING ENGINE

### OPENING METHOD OF EACH COVER

#### ■ Opening Hood

Opening	Closing
1. Pull in the hood lock pin to unlock. 2. Use the key to pull.	1. Lift the hood slightly to release the latch. 2. Lower the hood until locked.

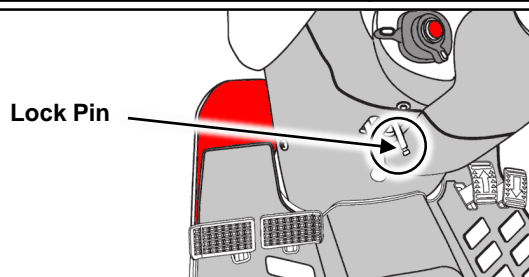

Opening

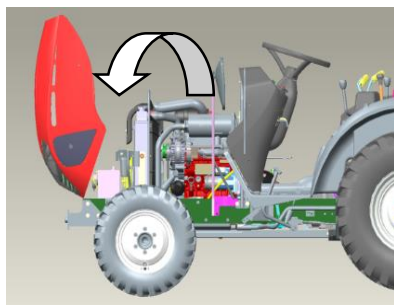

Closing

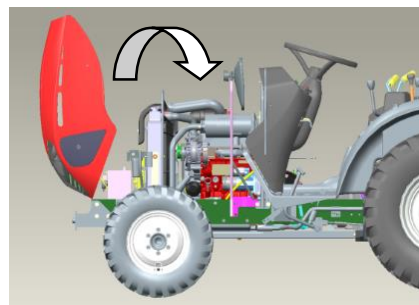



**ENGINE OIL**

**■ Checking Engine Oil**

1. Park tractor on level surface.
2. Check the engine oil when engine is cool enough.
3. Pull out the dipstick, wipe it clean and dip in the oil sump.
4. Ensure that oil level is near the upper mark between the upper and lower mark.
5. If too low, add oil through the oil filler cap, but never exceed 100 hours of service interval.

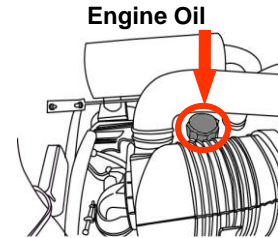

**■ Changing Engine Oil**

1. Park tractor on level surface, shut-off engine
2. Open the hood.
3. Remove the drain plug from the bottom of the oil pan and allow the oil to drain.
4. Replace and install the sump plug.
5. Fill the engine oil to the correct level on the dipstick (approximately 1.14 gal.).
6. The grade of oil to be used will depend on the ambient temperature.

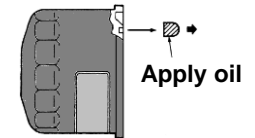
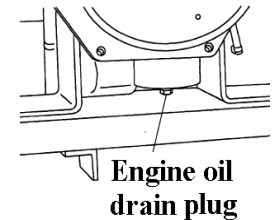

Shipped from factory : 10W/30  
 Temperature over 77°F : SAE 30  
 32 °C ~ 77 °C : SAE20 or 10W/30, below 32 °C : SAE 10W

**■ Changing Engine Oil Filter**

1. Remove the oil filter using a filter wrench.
2. Smear lightly the rubber seal on the new filter with oil to ensure.
3. Turn the filter clockwise until the seal contacts the base and then turn it another 2/3 turn to tighten it.

**Installing New Oil Filter**



**IMPORTANT**

When changing the oil always change the filter.  
 Always use the same oil, as using different oils or specifications can cause damage.  
 Dispose off the old oil as per local regulations.



## MAINTENANCE AND SERVICE

### AIR CLEANER

#### ■ Squeezing Dust

To remove the dust from the evacuator valve squeeze it between thumb and fingers to let excess dust out and wipe around the valve to keep it clean from outside.

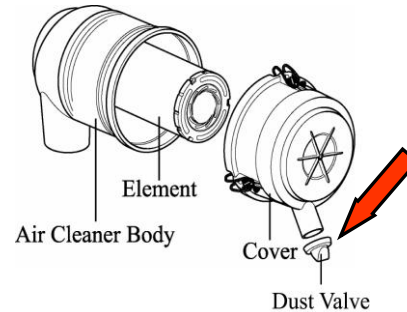

#### ■ Cleaning the Element

1. Open the hood.
2. Remove the element by unlocking the clamp.
3. Remove dust by blowing it out of the element with compressed air.
4. Check the element to ensure it is not damaged.
5. Reassemble the element.



- ▶ Replace the element after cleaning it 5 times or it is damaged.



IMPORTANT

Never beat the element on a stone or concrete floor/wall to clean it. Check all connections and hoses especially on the clean side of the air cleaner to ensure no dusty air can enter the engine.

Check the element for flaws by putting a light inside the element.

When reassembling make sure all surfaces seal correctly to keep dust out.

When working in dusty conditions increase the service frequency.

**ENGINE COOLANT**



**■ Checking Coolant**

1. Park tractor on level surface.
2. Check the coolant when engine is cool enough.
3. Open the hood.
4. Remove the radiator cap.
5. Ensure that the coolant is up to the filler neck and that it is clean with the correct anti-freeze or anti corrosion inhibitor in it.
6. If low, add coolant.

**■ Changing the Coolant**

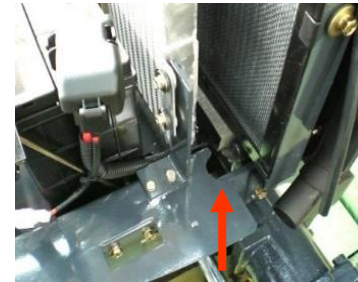
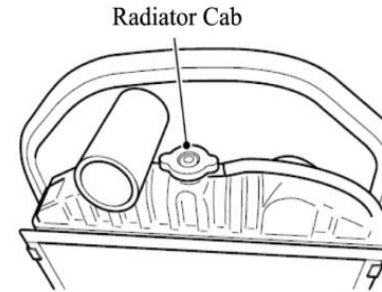
1. Park tractor on level surface.
  2. Shutoff engine. Allow engine to cool enough.
  3. Open the hood.
  4. Open the drain cock in front of the Radiator to drain the coolant.
  5. Open the radiator cap at the same time.
  6. To give a thorough clean run a hose into the radiator and flush it out.
  7. Close the cock.
  8. Fill the radiator with a coolant mixture of water and corrosion inhibitor or anti freeze.
  9. Close the radiator cap.
  10. Start the engine and allow it to run for approx. 5minutes.
- Check the water level again and top up if required.



 CAUTION	Do not remove the radiator cap on a hot engine. Allow the engine to cool down and then turn the cap slowly to ensure, that there is no excessive pressure in the radiator.
 DANGER	Serious burns, can result from the contents of pressurized, hot radiators. Allow the engine to cool down completely before opening radiator cap.



## MAINTENANCE AND SERVICE

### ■ Cleaning the Radiator and Cover

Insects, grass straw and dust can all block the radiator and reduce its efficiency.

1. Park tractor on level surface, shut-off engine
2. Open the hood.
3. Remove the radiator cover (pull upward) and clean it.
4. Clean the radiator between the fins and tube by using low pressure compressed air or clean water.

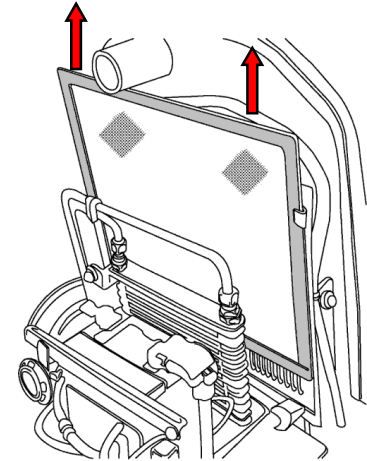

### ■ Anti Freeze

Frozen cooling water can damage the engine.

Before replacing the anti freeze solution flush the radiator.

Mix the anti freeze solution in accordance with the instructions applicable to the brand of anti freeze and the locals climate.

Replace the solution in the radiator.

In case of loss of solution due to evaporation or overflow, replace with the original mixture ratio.

**FUEL**

Use clean diesel fuel only.

■ **Checking and Refueling**

1. Turn key switch ON.
2. Check the fuel level with the fuel gauge on instrument panel.  
If fuel is near to empty, the empty warning lamp turns on.
3. Fill the fuel tank, if too low.
4. It is a good practice to refill the tank immediately after use to avoid condensation.

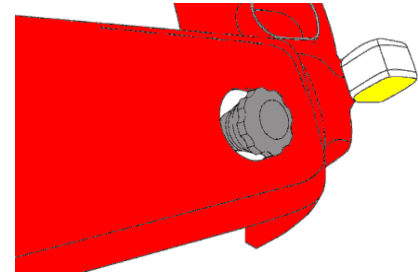

 <b>IMPORTANT</b>	<p>As diesel fuel equipment is susceptible to contamination by dust or water, Ensure that all dust and water is kept well away from the fuel tank.</p>
---	--

■ **Cleaning the Fuel Filter**

This is the primary filter and removes water and coarse dirt from the fuel.

1. Close the fuel cock.
2. Remove the filter.
3. Wash it or replace the filter element.
4. Bleed the air from the filter.

①

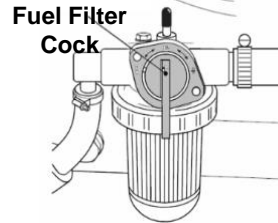

②

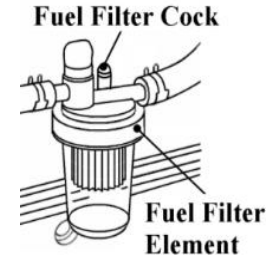

 <b>IMPORTANT</b>	<p>Never use petrol (gasoline) thinner or similar inflammable material to wash the primary fuel filter. After replacing the filter always bleed the system.</p>
---	---



## MAINTENANCE AND SERVICE

### ■ Bleeding the Fuel System

The fuel system is to be bled whenever the tractor has run out of fuel or when filters, pipes or other components have been replaced.

1. Fill the tank with fuel.
2. Open Fuel filter cock.
3. Turn the key "ON" position for a while.
4. Start the engine and allow it to run for a while.
5. Stop the engine.
6. The bleeding of the system is now finished.

### FAN BELT

Check the fan belt tension regularly and adjust if required.

The correct tension is if the center of the belt is pushed.

With a finger it moves in approx. 10 to 12 mm

(0.4 to 0.5 in) under 10Kgf [98N] as shown in the picture.

To adjust the fan belt loosen the top bolt on the alternator, Move the alternator to the desired position and tighten the bolt.

Also ensure that the bolts at the bottom of the alternator are tight.

### CHECKING HOSES AND CLAMPS

The fuel lines, radiator hoses, hydraulic and rubber hoses are consumables, which deteriorate by age and use. Check them regularly and replace if faulty.

#### ■ Checking the Fuel Hoses

1. Park tractor on level surface.
2. Shutoff engine. Allow engine to cool enough.
3. Open the hood.
4. Check the fuel hoses for damage and leakage
5. Replace if required.
6. Tighten clamps.

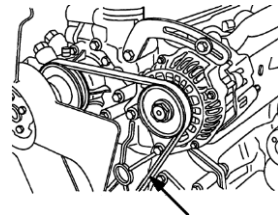

10 to 12 mm under 10Kgf[98N]

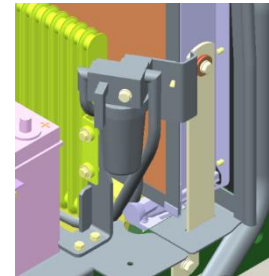



■ **The Air Intake Hoses and Clamps**

1. Park tractor on level surface.
2. Shutoff engine. Allow engine to cool enough.
3. Open the hood.
4. Check the air intake hoses for damage.
5. Tighten clamps.

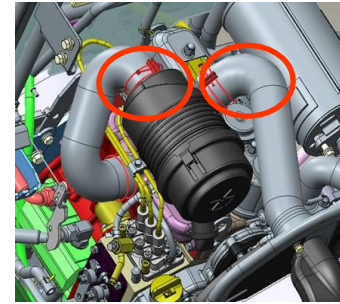
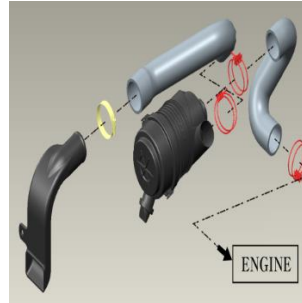

■ **The Radiator Hoses and Clamps**

1. Park tractor on level surface.
2. Shutoff engine. Allow engine to cool enough.
3. Open the hood.
4. Check the radiator hoses for damage and leakage.
5. Replace if required.
6. Tighten clamps.

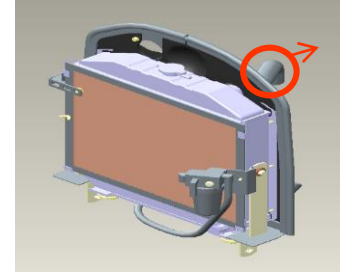

 <b>CAUTION</b>	<p>Damaged fuel lines leak and cause fires.                  Damaged radiator hoses can cause hot water burns and in severe cases seize the engine.</p>
---	---

 <b>IMPORTANT</b>	<p>Incorrect wiring or fuses can cause fires to both the tractor and surrounding area so get the dealer to check it annually.                  Likewise fuel pipes and wiring age with use.                  Ask your dealer to check it at least once every 2 years and replace as required.</p>
---	---



## 3. SERVICING TRANSMISSION

### TRANSMISSION OIL

The transmission oil is used to lubricate and used as hydraulic fluid.

It is important to use the proper oil.

Using the recommendation oil is preferred for better performance.

Consult authorized dealer/distributor for details.

**Transmission Oil Capacity : 4.5 gal.**

#### ■ Checking Transmission Oil

1. Park tractor on level surface
2. Lower the implements to ground.
3. Shutoff engine.  
Allow transmission oil to cool enough.
4. Check the level with the sight window on rear side of the transmission in rear of the seat.

If the level is low add oil through the filler hole.

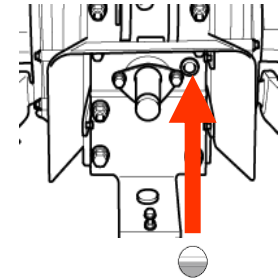

Oil level Window



CAUTION

Always ensure that you use the correct oil for topping up or oil changes.



IMPORTANT

Always use the same grade and specified oil as replacements.  
Dispose off the old oil as per local regulations .



## ■ Changing Transmission Oil and Filter and Cleaning Strainer

1. Park tractor on level surface.
2. Lower the implements and shutoff engine.
3. Remove the drain plug at the bottom of the transmission case (and drain plug at the side of mid PTO case, if mid PTO kit is assembled).
4. Drain the oil completely into container.
5. Loosen the hose clamp and detach the hose from the strainer.
6. Remove the bolt and remove the strainer.
7. Clean the strainer.
8. Reinstall the strainer, bolt and hose.
  
9. Remove the HST filter at the front of the HST unit with filter wrench.
10. Smear lightly the rubber seal on the new filter with oil to ensure.
11. Tighten the filter until the seal contacts the base and then turn it another 2/3 turn to tighten it.
12. Remove the transmission oil cap at the top of hydraulic cylinder case.
13. Fill the transmission oil to the correct level on the sight window.
14. After filling, install the cap.
15. Run engine for a few minutes and stop it.
16. Check the oil level. Add if required.

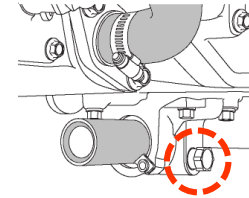

Drain plug of MID PTO

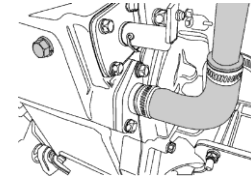

Drain plug of transmission case

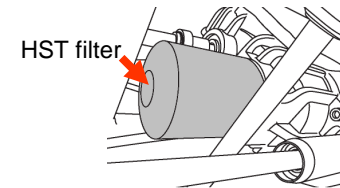

HST filter

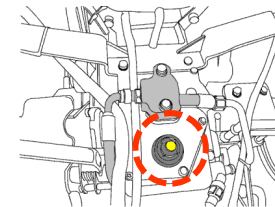



## MAINTENANCE AND SERVICE

### FRONT AXLE OIL

Use SAE 80 or SAE 90 gear oil for the front axle oil. Do not mix different grades.

**Front Axle Oil Capacity : 1.14 gal.**

#### ■ Checking Front Axle Oil

1. Park tractor on level surface.
2. Lower the implements and shutoff engine.
3. Remove the oil cap.
4. Wipe the dipstick on oil cap. Dip and screw the oil cap into the front axle.
5. Unscrew oil cap and pull out.
6. Check the level with the dipstick. If the level is low add oil through the filler hole.

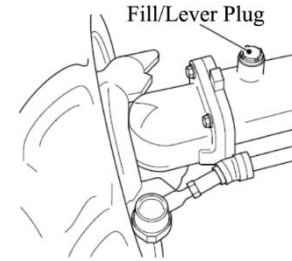

CAUTION

Always ensure that you use the correct oil for topping up or oil changes.

#### ■ Changing Front Axle Oil

1. Park tractor on level surface.
2. Lower the implements and shutoff engine.
3. Remove the front axle oil cap.
4. Remove the drain plug at the bottom of the front axle case and the drain plugs at the front of the both spindles.
5. Drain the oil completely into container.
6. Install the drain plugs correctly.
7. Fill with new oil to the correct level in the filler hole.
8. Reinstall the oil cap.

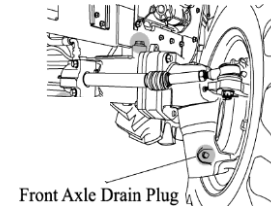



## 4. SERVICING ELECTRICAL

### BATTERY

The original battery is maintenance free. But the water in the electrolyte can evaporate during use. So it needs to service for longer life.

#### ■ CHECKING THE BATTERY

The electrolyte level of the battery can evaporate during use thus lowering the level.

Where it does so replace it with distilled water.

Where a spillage has reduced the level, replace it with electrolyte.

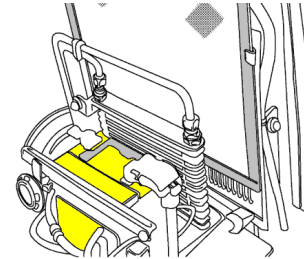

IMPORTANT

**Low electrolyte levels can cause premature battery failure and corrosion.**



CAUTION

Electrolyte contains acid and can cause serious burns.  
Any spillage on skin should be washed off by running water immediately.

#### ■ Battery Maintenance

Low temperatures will affect the performance of batteries so take particular care of it in winter.

For long-term storage of the tractor, remove the battery and keep it in a cool dry room.

If it is on the tractor while stored, disconnect the negative terminal.

Batteries will self discharge if left for a period of without use time.

To keep them in good condition charge them once a month in summer and every second month in winter.

When replacing the original battery, ensure that the replacement battery is the same size.

Failure to do so can cause problems with the electrical circuit.



## MAINTENANCE AND SERVICE

### **CHECKING THE WIRING HARNESS AND FUSES**

Loose wires make inferior connections and damaged wires can cause short circuits, fires burnt wiring or reduce efficiency of components. Replace or repair any faulty wiring or insulation.

**If a fuse burns out again after it has been replaced, do not replace it with wire or a high capacity fuse, find the cause and rectify it or get an auto electrician to do so.**

Where insulation is chafed or peeled off, recover the area with a good quality insulation tape.

Where wiring comes out of it's fitting replace it correctly with the standard fitting.



**IMPORTANT**

Incorrect wiring or fuses can cause fires to both the tractor and surrounding area so get the dealer to check it annually.

Likewise fuel pipes and wiring age with use.

Ask your dealer to check it at least once every 2 years and replace as required.

### **■ REPLACING FUSES**

The circuit has blade type fuses in its wiring circuit.

When a fuse has blown replace it with one of the same value.

Using a large capacity fuse or wire burn out the wiring system.

Use fuse tongs to replace fuses.

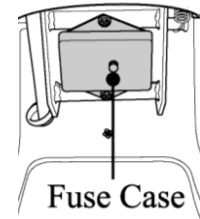
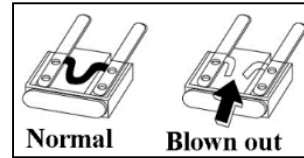

### **■ MAIN FUSES**

The wiring harness is equipped with main fuses who's function is to preserve the wiring.

However when a main fuse blows the entire circuit is dead.

Always check the reason & rectify before replacing the fuse of the same value.

To indicate that the fuse is blown it will be discolored.



**IMPORTANT**

Always check the reason for a blown fuse otherwise the new fuse is also likely to blow.

**NEVER EVER USE WIRE** in place of correct grade fuse.

## 5. SERVICING MISCELLANEOUS

### GREASING THE TRACTOR

Grease the tractor according to the service schedule.

Ensure that grease nipples are cleaned well before any attempt is made to grease them.

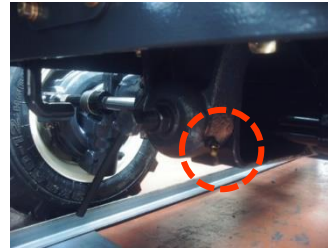
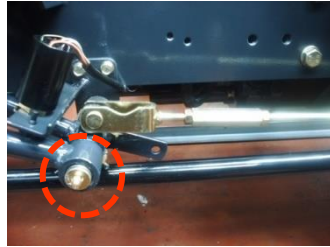
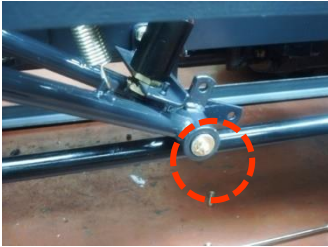

4

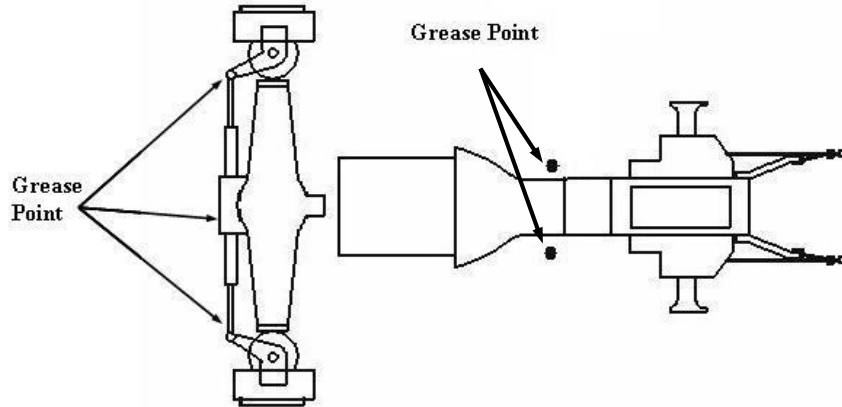



### GAP ADJUSTMENT ON THE FRONT AXLE

Lift the front with a hydraulic jack to get the wheels off the ground.

Then loosen the nut and tighten the bolt fully and turn the bolt ½ to loosen again in order to roll the center pivot metal freely and tighten the nut again.

While the wheels are still off the ground, move the axle on the center pivot as a final check that the gap is set correctly on the top of the pivot metal.



### ADJUSTING THE BRAKES

Use of the brakes will change the pedal free play and the balance between the right and left pedal.

**The correct pedal free play is 1.18 ~ 1.57in.**

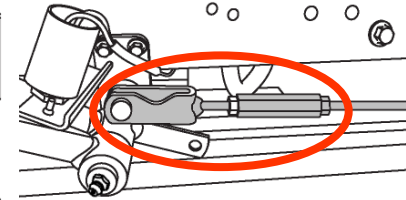
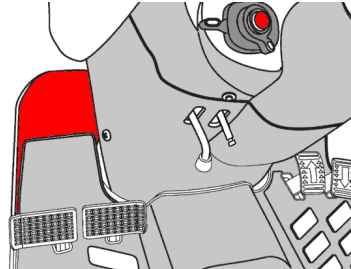

#### ■ Adjustment Method

Loosen the locknuts at each end and turn the rod to adjust the brake.

Turning it anticlockwise increases the free play, clockwise decreases it.

Tighten the locknuts.

Check that the free play is correct and the same on both pedals to ensure even braking.



CAUTION

Uneven adjustment of the left and right pedal will result in one sided braking when the pedals are connected and can cause serious accidents, especially at high speeds.

**Double check to ensure free play is the same on both pedals.**



**ADJUSTING THE THROTTLE LEVER**

If this lever is either loose or difficult to move please consult your dealer for rectification of the problem.

**ADJUSTING TOE-IN**

If the toe-in adjustment is incorrect it can cause severe shaking of both the steering wheel and the entire tractor.  
The correct toe-in is **0.08 ~ 0.24 in.** We recommend that the adjustment is made by the dealer.

**TIRE PRESSURE**

The air pressure used in the tires has a direct bearing on the life of the tire and its performance in the field.

Ensure that the tire pressures are correct and in accordance with the table.

To make a visual judgment see the drawing on the right.



**Excess   Standard   Lack**

 IMPORTANT	It is strongly recommended that tire pressures are checked with a proper gauge only & visual inspections are relied upon.
--	---

 DANGER	Excess tire pressure can cause accidents!
---	---



### 6. STORAGE

#### SERVICE PRIOR TO DAILY AND SHORT TERMS STORAGE

Wash the tractor and keep it clean.

Fill the tank to avoid condensation and rust.

Lower any attached implement to the ground before parking the tractor.

For long-term storage consult your dealer.

#### FOR DAILY OR SHORT TERM STORAGE

Clean the tractor and remove all dirt from field work.

Fill the fuel tank to avoid condensation and rust.

Lower the implement to the ground.

Keep it in a machinery shed or, if not available cover the unit if left outside.

In very cold conditions it is advisable to remove the battery and keep it inside in a warm environment.

This will ensure effective starting when the tractor is required.

When the outside temperature is below 32°F, replace the Antifreeze completely or drain the coolant to protect the engine from damage from frozen coolant.



#### IMPORTANT

When washing the tractor ensure that the water does not get near electrical components or the oil filter points.  
To prevent short circuits remove the ignition key.  
Do not wash the tractor when the engine is running.

**LONG-TERM STORAGE.**

When the tractor will not be used for a long time carry out the cleaning as for short term storage.

Drain the oil and replace with new oil.

Run the engine for approx. 5 min. to ensure that it has new oil throughout the engine.

Drain the coolant from the radiator and remove the ignition key.

Attach a tag both the key and the steering wheel saying " No coolant".

Lubricate all grease and oil points on the tractor.

Check the pressures and add a small amount of extra pressure.

Lower any implement to the ground or store in a shady dry place.

Place a piece of wood under each tire to preserve the tire.



IMPORTANT

After refilling the engine with the coolant run the engine for approx. 5-10 min. at 1500-2000rpm every month as a corrosion prevention measure.

Either removes the battery or the negative terminal as mouse damage to wiring can cause short circuits and fires.

Remove the ignition key and store in a safe place.

**RE-USE AFTER LONG TERM STORAGE**

Carry out a full check of all oils and coolant.

Refit the battery and run the engine at idle for 30 min. to ensure optimum engine life.



### 7. FUEL SAVING TIPS

To save fuel & oil in your tractor, following things should always be kept in mind.

#### AIR CLEANING SYSTEM

1. Clean the air cleaner regularly so that dust does not settle down.
2. For every 50 hours & everyday in sandy/dusty conditions.
  - Clean the air cleaner filter element with compressed air.
  - If the rubber ring is cut or expanded then change it with an appropriate one.  
Fix the rubber at the proper location & check for leakages if any.
  - If air is leaking through the hose connection, check & rectify other leakages, too.

#### -NOTE

If air cleaning system is not properly maintained, it will lead to early wear of piston rings & sleeves. This will lead to problems like loss of engine power, excessive oil consumption fuel consumption.

#### ENGINE

1. Put the engine oil on load after the engine is heated & the water temperature gauge indicates the needle to be in the green zone.
2. If excessive black smoke is visible, then the paper element of air cleaner, Fuel injection pump or nozzles should be checked.
3. Do not run the engine without load for more than 2 minutes.  
It is better to stop the engine rather than run it idle. This will help in saving of fuel.

#### BRAKES

1. If the tractor has to be stopped for a long period, it is advisable to bring the transmission in neutral position.
3. Do not over ride the brake pedals.
4. While coming down from a slope, reduce the engine throttle & use low gear.  
Do not depend only on the brakes for stoppage.

**FUEL SYSTEM**

1. Always use filtered diesel for the fuel system.
2. At the end of the day's working, it is preferable to fill the diesel tank so that it may prevent condensation.
3. Change the filter, if the system gets choked.  
Do not change both the filters at the same time.  
If the above directives are not adhered to, the fuel injection pump & injection nozzle will lose its life early.  
Also, it will lead to excessive black smoke & excessive diesel consumption.

**OIL SYSTEM**

1. Always use recommended grade of oil.
2. Everyday before starting the engine, check the oil level with a dipstick & refill between the minimum & maximum level.
3. Change the engine oil. Replace filter & "O" ring, as & when required.

**COOLING SYSTEM**

1. Check the fan belt tension regularly. Adjust, If required.
2. Check the coolant level in the radiator fins always clean.
3. Replace the radiator cap with a genuine cap only, if required.
4. Do not remove the thermostat but replace with a new one, if required.
5. Do not change the radiator water often.

**-NOTE**

- 1) Always stop any fuel or oil leakages.
- 2) Carry out the regular maintenance failure to do so might increase the fuel consumption by 25%.
- 3) Carry out the torque of cylinder head bolt & adjustment of valve clearance regularly.  
Consult your dealer for this.
- 4) Check the tire pressure & inflate, as recommended.

**-NOTE**

- 1) Always buy genuine spares from the authorized Dealer/Distributor.
- 2) Always carry out the service of the tractor by your authorized Dealer/Distributor.

※ For any other information, contact your nearest Authorized Dealer/Distributor.



## 8. HOW TO USE OF JACKS

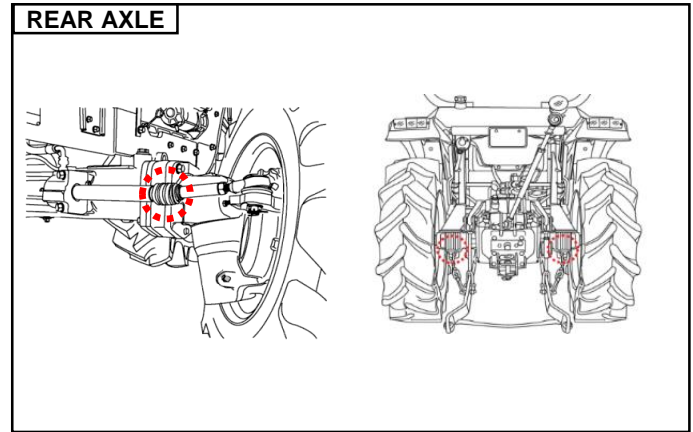
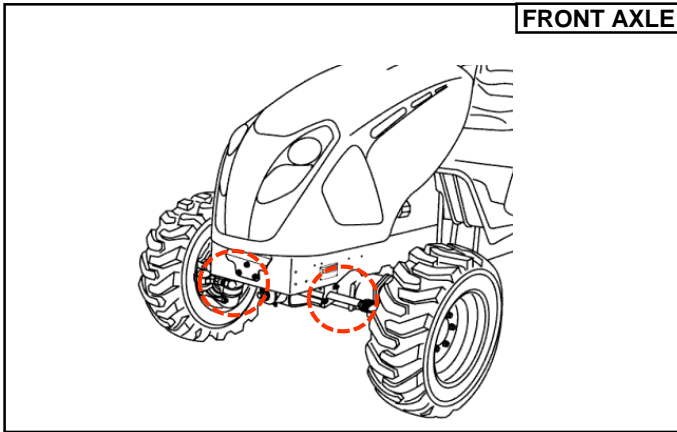

- If the tractor must be lifted for servicing, take it to a suitably equipped workshop.
- Carry out the following operations before any operation about the tractor.
  - Engage the four-wheel drive, the first gear and the parking brake and put chocks to the wheels touching the ground.
- Before lifting the tractor, avoid its swinging by means of wooden wedges applied to the front axle
- Use jack lifts of suitable capacity and apply them at the center of the front and rear axles and paying due attention to weight distribution.
- No decals for the lifting point are applied on the tractor, as they would be, too difficult to apply in the available spaces and would be all too easily removed or effaced during normal operation of the tractor.

**-NOTE**

Apply the jack lift to the lifting points according to the type of operation and following the safety procedures given before.

**9. TROUBLESHOOTING**

	SYMPTOM	CAUSE	REMEDY
Engine	Turning the master brake, switch will not operate the starter	Battery flat Switch faulty	Charge or replace the battery Dealer to repair or replace Contact dealer for repair or replace
	Starter operates but not enough to turn the engine	Low battery Bad earth Thick oil	Charge the battery Clean the earth lead and tighten Drain and replace with correct oil
	Starter operates OK but does not start the engine	Air in fuel system Clogged fuel filter No fuel being supplied Glow plug disconnected or not working	Bleed the system Clean or replace both filters Fill tank or turn tap on Contact dealer for repair.
	Engine revolutions are irregular	Air in the fuel system Faulty injector Fuel pipe leak	Bleed the system Contact dealer for repair. Contact dealer for repair
	The engine stops at low revolution	Poor fuel injection Faulty injection pump Wrong valve clearance Wrong idle setting Faulty injector	Contact dealer for repair Contact dealer for repair Contact dealer for repair Contact dealer for repair Contact dealer for repair
	The engine revs. is too high	Faulty governor	Contact dealer for repair
	The engine stops suddenly	Lack of fuel  Faulty injectors Seized engine due to lack of oil, the wrong oil or lack of coolant Sensitivity of safety device is too high	Fill the tank and bleed the fuel system Contact dealer for repair Contact dealer for repair  Check safety device or Contact dealer for repair



## MAINTENANCE AND SERVICE

	SYMPTOM	CAUSE	REMEDY
Engine	The engine overheats	Lack of coolant Broken or misadjusted fan belt Clogged air filter element Clogged radiator Low oil	Refill with coolant Adjust or replace Clean or replace air filter Clean the core Replace the oil to correct grade
	Reduced performance of the engine	The injectors are clogged, carbon coated and sticking Low compression Leaking valve seat Incorrect valve gap Faulty timing Fuel shortage Clogged air cleaner	Contact dealer for repair  Contact dealer for repair Contact dealer for repair Contact dealer for repair Fill the tank and check fuel quality Clean the element
	Oil warning light comes on with the engine running	Low oil level Wrong oil Faulty light or switch Clogged oil filter	Low oil level Wrong oil Faulty light or switch Clogged oil filter
	Alternator light comes on with the engine running	Wiring fault Faulty alternator Low water level or faulty battery Broken or loose fan belt	Contact dealer for repair Contact dealer for repair Top up or replace Replace or adjust
Brake	Brake not working	Incorrect free play Worm or burnt lining Left and right gap different	Adjust to correct free play Contact dealer for repair Equalize
	Brake pedal not returning	Faulty return spring	Replace spring
Steering Wheel	Steering wheel shaking	Wrong toe in Unequal tire pressure Loose components	Adjust toe in Inflate both to correct pressure Tighten or replace if worn
	Excessive play in the steering	Worn steering shaft Worn components	Contact dealer for repair Contact dealer for repair





SYMPTOM		CAUSE	REMEDY
Hydraulic system	Hydraulics are not lifting	Engine revs. too low Lack of transmission oil Air leaking in from a pipe  Clogged suction filter Faulty pump Faulty hydraulic valve Faulty cylinder	Increase engine revs. Top up the oil to the correct level Repair or replace pipe or replace O ring on joint and tighten Clean and change oil Contact dealer for repair Contact dealer for repair Contact dealer for repair Contact dealer for repair
	Oil leak from pipe	Loose pipe joint Cracked pipe	Tighten joint Replace or repair pipe
	When lifting relief valve whistles	The stopper has slipped down	Adjust the stopper
For any other hydraulic problems, please consult your dealer who has the correct equipment to diagnose and repair the system.			
Electrical System	Flat battery	Faulty wiring Faulty alternator Faulty regulator Broken or loose fan belt	Repair, reconnect or tighten as needed. Contact dealer for repair Contact dealer for repair Replace or adjust
	Before anything else, check the electrolyte level of the battery and the connections. Top up if required and clean and retighten the terminals		
	Dim headlights	Low battery Faulty wiring	Charge or replace Repair or replace as needed
	Headlights not working	Blown bulb Blown fuse Faulty contact	Replace bulb Replace fuse Repair or replace and check the earth
	Horn not working	Faulty horn button Faulty wiring Faulty horn	Replace button Repair or replace Replace
Indicator not working	Blown bulb Faulty flasher unit Faulty wiring	Replace bulb Replace unit Repair or replace	



**10. TOWING THE TRACTOR**

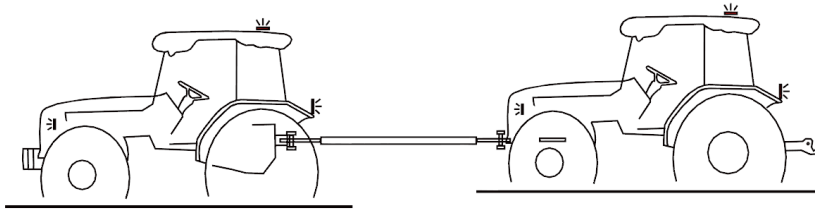

The tractor can be towed only for short distances, such as, for example, from inside to outside a building. A broken down tractor should be towed for the minimum indispensable distance to remove it from potentially dangerous conditions.

Observe all legal provisions as envisaged in the highway code relative to national legislation regarding towing maneuvers.



**CAUTION**

We recommend transporting the tractor on a low loader in the case of longer transport distances.  
Comply with the maximum width and height regulations for road transport.  
Check that the loader is suitable for the weight of the tractor to be transported.



**CAUTION**

An operator must always be at the tractor's controls when the tractor is being towed.



**DANGER**

**NEVER** permit other persons to access the tractor operator position during towing.

**TOWING WITH THE ENGINE RUNNING**

Towing with the engine running can be performed if forced gearbox lubrication is ensured:

- Engine speed between 1200 - 1300 rpm.
- Maximum towing speed 5 mile/h
- Maximum towing distance 0.6 mile

For towing the tractor use only a standard bar applied to the front towing hitch approved by the manufacturer.

Make sure to use the correct pin for the towing hitch and that it is secured with its locking pin.

Clean all lights required for road use, front and rear, and make sure they are in working order

Before starting towing check the following conditions:

- Unhitch any implement from the tractor;
- Lock the two brake pedals together with the connecting latch;
  - Disengage the power take-off and differential locks;
  - Set the shuttle control lever and gear lever to neutral;
  - Move the range lever to the "fast" position;
- Move the creeper lever to neutral;
- Display the SMV (Slow Moving Vehicle) sign and turn on the rotating beacon and hazard lights



DANGER

Switch on the hazard warning lights and revolving warning lights.

Affix suitable notices indicating that the tractor is being towed.

Observe and follow the relevant national regulations.

Observe local safety regulations.



## MAINTENANCE AND SERVICE

---

During road transfers observe the following instructions:

- Wait until traffic thins before joining the road.  
Exert caution in the proximity of unregulated intersections.
- Slow down until you have a clear view in both directions.

- Keep in your lane and drive as close as possible to the curb.

If a tailback builds up behind you pull into a lay-by as soon as possible to allow the traffic to pass

- When stopping the tractor (in any circumstances) apply the parking brake.

- Travel speed must ALWAYS be such as to allow complete control and stability of the tractor  
in all conditions.



DANGER

Never attempt to tow the tractor with ropes (including steel ropes) because rope  
Breakage can cause serious injury.

### TOWING WITH THE ENGINE OFF



IMPORTANT

With engine stopped and with forced gearbox lubrication system inoperative the  
Tractor can be transferred to a service center only when loaded onto a  
transporter.

With engine stopped and with forced gearbox lubrication system inoperative the tractor should not  
be towed except when safety is at risk.

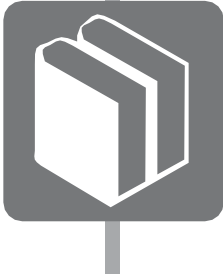

## **SPECIFICATION AND TIPS**

<b>1. SPECIFICATION .....</b>	<b>5-2</b>
<b>2. SPECIFICATION TABLE .....</b>	<b>5-3</b>
<b>3. MASS AND TIRE .....</b>	<b>5-4</b>
<b>4. NOISE LEVELS .....</b>	<b>5-5</b>
<b>5. VIBRATION REFERRED TO THE OPERATOR POSITION .....</b>	<b>5-6</b>



### 1. SPECIFICATION

The specifications on the following pages are given for your information and guidance.

For further information concerning your Tractor and equipment, consult your Authorized TYM Dealer/Distributor.

TYM CO.,LTD policy is one of continuous improvement and the right to change prices, specifications or equipment at any time without notice is reserved.

All data given in this book is subject to production variations.

Dimensions and weights are approximate only and the illustrations do not necessary show Tractors in standard condition.

For exact information about any particular Tractor, please consult your TYM Authorized Dealer/Distributor.



2. SPECIFICATION TABLE

Model		T264NH	
Engine	Manufacturer	KM	
	Model	KM A1100N2	
	Type	Natural Aspiration	
	Number of Cylinders	3	
	Total Displacement (cu.in) cm <sup>3</sup>	80.4 (1,175)	
	Gross Power kW (HP)	18 (24.5)	
	Rated Speed rpm	2,600	
	Maximum Torque N-m (lbf-ft) @ rpm	76.3(56.3) @2,00	
Electrical System	Battery	12V, 50AH	
	Alternator	12V50A	
Drive Train	Transmission Type	HST	
	Number of Speeds	Infinite / 2 Range	
	Brakes	Wet Disc	
	Steering	Hydrostatic	
	Clutch	N/A	
3 Point Hitch	Pump Capacity (Main) gpm (L/min)	16.6	
	Pump Capacity (Power Steering) gpm (L/min)	8.8	
	Number of standard remote valves	1	
3 Point Hitch	Type	I	
	Lift Capacity	Lift Points (lbs.)	1,534
		25-in. Behind Lift Points (lbs.)	1,102
	Lift Control Type	Position	
PTO	Type	Independent	
	Control	Electric/Hydro	
	Mid (Option) rpm	2,000	
	Rear rpm	540	
	Shaft Diameter (mm)	35, 6 Splines	
Fluid Capacities	Fuel Tank (gal.)	6.6	
	Cooling System (qt.)	5.9	
	Crankcase (with filter) (qt.)	4.5	
	Transmission & Hydraulic System (gal.)	5.8	
	Front Axle (qt.)	4.7	
Dimensions	Overall length with 3-Point Hitch (inch)	107.8	
	Overall width (inch)	52.8	
	Overall Height (inch)	89.9	
	Wheelbase (inch)	58.3	
	Min. Ground Clearance (inch)	7.71	
	Min. Turning Radius without brakes (inch)	105.5	
Weight with ROPS or Cab (lbs.)		1907	
Tire	Front	R1 / R3 / R4 6-12 / 25x8.5-14 / 23x8.5-12	
	Rear	R1 / R3 / R4 9.5-20 / 36x12.5-15 / 12x16.5	

### 3. MASS AND TIRE

		Axle no.1						
		Load capacity(x2)						
		1334	1306	650	1490	1014		
		Tyres (dimensions)						
		Combination	Permissible maximum Mass on rear axle	23x8.5-12, 4PR	23x8.5-12, 6PR	6-14 4PR	25x8.50-14 6PR	25x8.5-14,4PR
		Permissible maximum Mass on front axle		1000	1000	650	1000	1000
Axle no.2	Load capacity(x2)	3830	Tyres (dimensions)	12-16.5, 6PR	2000	2500		
		2092		33x12.50-16.5 4PR	2000		2500	
		1942		9.5-20 8PR	1940			2500
		2360		36x13.5-15 4PR	2000			2500
		3460		14-17.5, 10PR	2000			

(\*) According to the tyre specification.

(\*\*) Load transmitted to the reference centre of the coupling under static conditions, irrespective of the coupling device; if the maximum permissible vertical load on the coupling point depending on the coupling is indicated in this table, expand the table at the right side and indicate the identification of the coupling device in the header of the column; for R- or S-category vehicles this column(s) concerns the rear coupling devices if there is such a device.

(\*\*\*) Value to be provided only if the maximum permissible vertical load on the coupling point is lower than indicated in entries 38.3 and 38.4.

#### MAX TRAVELING SPEED

(mile/h)

Range shift		Model	
		T264NH	
R1	L	4.1	
	H	9.63	
R3 &R4	L	4.1	
	H	9.63	

※ The specifications are subject to change for improvement without notice.





## 4. NOISE LEVELS

The tractor is approved in accordance with the applicable EC Directives.

### To avoid increased noise levels proceed as follows:

- After maintenance operations or repairs refit all the sound-deadening panels and materials correctly
- Do not make changes to the tractor that may lead to an increase in noise emissions.
- Beware of any anomalous noise or vibration if you notice anomalous noise or vibration, park the tractor in a safe position and perform the stopping procedure. Inform maintenance personnel of the situation. Avoid prolonged operation.

### Reference standards for the measurement of noise levels:

- The maximum driver-perceived noise level, with the engine at normal operating temperature and measured in accordance with the test method described in the European Directive 2009/76EC.

Model	NOISE LEVELS
	ROPS Driver-perceived sound level[dB(A)]
T264NH	84.9

- The maximum noise level measured with the tractor in motion and the tractor stationary, measured in accordance with the method described in European directive 2009/63/EC.

Model	NOISE LEVELS	
	Maximum external noise level With tractor moving, db(A)	Maximum external noise level With tractor stationary, db(A)
T264NH	76.0	75.5



### 5. VIBRATION REFERRED TO THE OPERATOR POSITION

**In order to minimize the vibration transmitted to the whole-body the following best practice rules should be observed**

- Use the most suitable implement for the tractor and the task in hand
- Adjust the seat to suit your weight and stature
- Periodically check the condition of the cab suspensions and renew them if damaged
- Check tire inflation pressure
- Use front axle suspensions, if fitted
- During transfers, adjust tractor speed in order to minimize the vibration level.

The seat vibration values, as obtained from the seat approval in compliance with 78/764/EEC (amended by 1999/57/EC) are shown in the following table.

#### Technical data

Input vibration : Category A, Class I ,II and III

Ambient temperature : 73.4°F

Seat type			Corrected vibration level on seat
W10SSS	Light driver	59kg	1.24m/sec <sup>2</sup>
	Heavy driver	98kg	1.12m/sec <sup>2</sup>



# INDEX

1. INDEX ..... 6-2

<b>A</b>	
ABOUT THIS MANUAL .....	2-2
ADJUSTING OF THE CHECK CHAIN .....	3-27
ADJUSTING OF THE LOWER LINK .....	3-28
ADJUSTING OPERATOR SEAT.....	3-10
ADJUSTING THE BRAKES .....	4-18
ADJUSTING THE THROTTLE LEVER .....	4-19
ADJUSTING THE TOP LINK .....	3-27
ADJUSTING TOE-IN .....	4-19
ADJUSTMENT OF THE YOKE ROD ON THE LOWER LINK ...	3-28
AIR CLEANER.....	4-4
ANTI FREEZE .....	4-8
<b>B</b>	
BATTERY .....	4-15
BATTERY MAINTENANCE .....	4-15
BLEEDING THE FUEL SYSTEM.....	4-10
<b>C</b>	
CHANGE TRANSMISSION OIL AND FILTER AND CLEANING STRAINER .....	4-13
CHANGING ENGINE OIL .....	4-5
CHANGING ENGINE OIL FILTER .....	4-5
CHANGING FRONT AXLE OIL .....	4-14
CHANGING THE COOLANT.....	4-7
CHARGE LAMP .....	3-6
CHECKING AND REFUELING .....	4-9
CHECKING COOLANT .....	4-7
CHECK DURING DRIVING .....	3-20
CHECKING ENGINE OIL.....	4-5
CHECKING FRONT AXLE OIL.....	4-14
CHECKING HOSES AND CLAMPS.....	4-10
CHECKING THE BATTERY.....	4-15
CHECKING THE FUEL HOSES.....	4-10
CHECKING THE WIRING HARNESS AND FUSES .....	4-16
CHECKING TRANSMISSION OIL .....	4-12
CLEANING THE ELEMENT.....	4-6
CLEANING THE FUEL FILTER.....	4-9
CLEANING THE RADIATOR AND COVER .....	4-8
COLD WEATHER STARTING.....	3-13
CONNECTING AND DISCONNECTING IMPLEMENT.....	3-31
COOLANT TEMPERATURE GAUGE .....	3-3
COOLANT TEMPERATURE WARNING LAMP .....	3-6
CRUISE CONTROL .....	3-17
CRUISE CONTROL LAMP.....	3-5
CRUISE CONTROL SWITCH .....	3-4
<b>D</b>	
DECALS MOUNTING LOCATION.....	1-19
DETACHING THE LOADER .....	3-25
DIFF-LOCK PEDAL.....	3-18
DRIVING.....	3-15
DRIVING DOWNHILL.....	3-19
<b>E</b>	
ENGAGING PARKING BRAKE .....	3-12



<b>F</b>			
FANBELT.....	4-10		
FRONT AXLE OIL .....	4-14		
FRONT WHEEL DRIVE(4WD) .....	3-18		
FUEL EMPTY WARNING LAMP.....	3-5		
FUEL GAUGE .....	3-3		
FUEL SAVING TIPS .....	4-22		
<b>G</b>			
GAP ADJUSTMENT ON THE FRONT AXLE .....	4-18		
GENERAL SAFETY INFORMATION .....	1-19		
GLOW SIGNAL LAMP.....	3-6		
GREASING THE TRACTOR .....	4-17		
<b>H</b>			
HAND THROTTLE LEVER .....	3-11		
HAZARD WARNING LIGHT SWITCH .....	3-4		
HIGH BEAM LAMP.....	3-5		
HOUR METER .....	3-3		
HOW TO USE OF JACK .....	4-24		
HYDRAULIC OUTLET.....	3-25		
HYDRAULIC REMOTE CONTROL VALVE .....	3-26		
HYDRAULICS .....	3-23		
<b>I</b>			
INDEPENDENT PTO .....	3-7		
INDICATOR LAMPS .....	3-5		
INSTALLING THE LOADER .....	3-25		
INSTRUMENT PANEL AND CONTROLS .....	3-2		
INTRODUCTION & DESCRIPTOIN .....	2-4		
<b>K</b>			
KEY SWITCH .....	3-2		
<b>L</b>			
LIGHT SWITCH, INDICATORS AND HORN .....	3-3		
LIGHT TURNS IN THE FIELD.....	3-19		
LOW BEAM LAMP .....	3-5		
LOWERING SPEED CONTROL .....	3-24		
LUBRICATION CHART.....	4-3		
<b>M</b>			
MAIN FUSES .....	4-16		
MAINTENANCE AND ADJUSTMENT.....	4-2		
MASS AND TIRE .....	5-4		
MAX TRAVELING SPEED .....	5-4		
MID PTO .....	3-22		
MOUNTING AND DEMOUNTING IMPLEMENTS .....	1-12		
MOUNTING IMPLEMENT.....	3-28, 3-32		
<b>N</b>			
NOISE LEVELS .....	5-5		
<b>O</b>			
OIL PRESSURE LAMP.....	3-6		
ONE SIDE BRAKE .....	3-6		
OPENING HOOD .....	4-4		
OPERATING 3-POINT LINKAGE .....	3-27		
OPERATING THE ENGINE.....	3-10		
OPERATING THE TRACTOR .....	3-15		
OWNER ASSISTANCE .....	2-7		

<b>P</b>	
PARKING BRAKE LAMP .....	3-6
PERIODICAL CHECK AND SERVICE TABLE .....	4-2
POSITION CONTROL .....	3-23
PRE-OPERATION CHECK .....	3-9
PTO .....	3-21
PTO MONITOR LAMP .....	3-5
PTO ON/OFF SWITCH .....	3-7
<b>R</b>	
RANGE SHIFT LEVER .....	3-15
REAR PTO .....	3-21
REPLACING FUSES .....	4-16
ROPS .....	2-8
<b>S</b>	
SAFE OPERATION OF THE TRACTOR .....	1-10
SAFETY INSTRUCTIONS .....	1-2
SAFETY TIPS DURING MAINTENANCE .....	1-11
SERVICING ELECTRICAL .....	4-15
SERVICING MISCELLANEOUS .....	4-17
SERVICING TRANSMISSION .....	4-12
SERVICING ENGINE .....	4-4
SPECIFICATION TABLE .....	5-3
SPEED CONTROL PEDALS .....	3-16
SQUEEZING DUST .....	4-6
STARTING THE ENGINE .....	3-10
STOPPING AND PARKING .....	3-16
STOPPING THE ENGINE .....	3-13
STORAGE .....	4-20
SWITCHES AND GAUGES .....	3-2
<b>T</b>	
TACHO METER .....	3-3
THE AIR INTAKE HOSES AND CLAMPS .....	4-11
THE PRECAUTION TO HELP PREVENT ACCIDENTS ...	1-13
THE RADIATOR HOSES AND CLAMPS .....	4-11
THREE-POINT HITCH AND DRAWBAR .....	3-27
TIRE PRESSURE .....	4-19
TOWING DEVICES .....	3-29
TOWING THE TRACTOR .....	4-28
TRACTOR IDENTIFICATION .....	2-3
TRANSMISSION OIL .....	4-12
TROUBLESHOOTING .....	4-25
TURN SIGNAL LAMP .....	3-6
<b>U</b>	
UNIVERSAL SYMBOLS .....	1-22
UPHILL START ON A STEEP SLOPE .....	3-19
USE OF THE RETENTION RUBBER .....	3-28
<b>V</b>	
VIBRATION REFERRED TO THE OPERATOR POSITION ...	5-6
<b>W</b>	
WARMING UP .....	3-14

**TRACTOR HISTORY CARD**

<b>DATE</b>	<b>JOB CARD NO.</b>	<b>NATURE OF DEFECT</b>	<b>PARTS REPLACEMENT</b>	<b>W/CLAIM NO. AND DATE</b>	<b>REMARKS</b>

**SERVICE RECORD**

<b>DATE</b>	<b>TRACTOR HOURS</b>	<b>NATURE/TYPE OF REPAIR/SERVICE CARRIED OUT</b>



**DAILY OPERATION LOG**

<b>DATE</b>	<b>JOB DONE</b>	<b>MACHINE HOURS</b>		<b>FUEL CONSUMPTION</b>	<b>ENGINE OIL TOPPED UP</b>	<b>EMARKS</b>
		<b>START</b>	<b>END</b>			

**PART REPLACEMENT RECORD**

<b>DATE</b>	<b>PART DESCRIPTION</b>	<b>QTY</b>	<b>COST</b>	<b>DATE</b>	<b>PART DESCRIPTION</b>	<b>QTY</b>	<b>COST</b>

**T264NH**

OPERATOR'S MANUAL FOR TRACTORS

CODE NO.

1363-912-002-0

Printed on April 2020

1st EDITION