





FOREWORD

- █ Thank you very much for purchasing our tractor which will give you many years of reliable service.
- █ The introduction in this manual sets out the correct manner of operating, maintaining and checking the tractor to ensure long-term durability.
- █ Please ensure correct operation of the tractor as incorrect can cause substantial mechanical damage as well as cause accidents with the associated injuries.
- █ Please note that in some cases differences can exist between this manual and your tractor due to the manufacture's policy of constant product improvement.
- █ In the event that you encounter a problem not covered by this manual, please contact your nearest dealer who will assist you in resolving your problem.



WARNING SIGNS

The following warning signs in this manual draw additional attention to items of importance for the safe and correct operation of the tractor.

SIGNS	MEANING OF THE SIGN
	This indicates that a condition may result in harm, serious injury or death to you or other persons if the warning is not heeded. Follow the advice provided with the warning signs.
	Hazard or unsafe practice that can lead to severe injury or death.
	Hazard or unsafe practice that can lead in injury or death.
	Instructions for the correct operation of the machine which, if followed, will ensure that it performs at its best.

All information, illustrations and specifications in this manual are based on latest information available at the time of publication. The right is reserved to make change at any time without a notice.

TABLE OF CONTENTS

A. GENERAL INFORMATION

A

B. SAFETY PRECAUTIONS

B

C. TRACTOR INSTRUMENTS

C

D. OPERATION

D

E. MAINTENANCE

E

F. TROUBLESHOOTING

F

G. STANDARD FOR FARMWORK

G

H. APPENDIX

H

I. INDEX

I

TABLE OF CONTENTS

A GENERAL INFORMATION

1. EXTERIOR VIEW A – 2
2. TRACTOR IDENTIFICATION A – 5
3. ABOUT THIS MANUAL A – 6
4. INTRODUCTION & DESCRIPTION A – 7
5. OWNER ASSISTANCE A – 9
6. ROPS (ROLL OVER PROTECTIVE STRUCTURES) A – 10
7. SEAT ADJUSTMENT A – 12

B SAFETY PRECAUTIONS

1. SAFETY INSTRUCTIONS B – 2
2. SAFE OPERATION OF TRACTOR B – 15
3. DOs & DON'Ts B – 22
4. SAFETY DECALS B – 24
5. UNIVERSAL SYMBOLS B – 29

C TRACTOR INSTRUMENTS

1. SWITCHES C – 2
2. MONITOR PANEL & GAUGES C – 5
3. CONTROL INSTRUMENTS C – 10
4. THREE POINT LINKAGE C – 16

D OPERATION

1. START & STOP OF ENGINE D – 2
2. OPERATING THE TRACTOR D – 4
3. OPERATION OF PTO D – 7
4. IMPLEMENTS D – 9
5. TOWING THE TRACTOR D – 10
6. CHECKS DURING DRIVING D – 12
7. WORK PROCEDURES D – 14
8. OPERATION TIPS D – 18

E**MAINTENANCE**

1. MAINTENANCE SCHEDULE····· E – 2
2. OPENING COVERS ····· E – 4
3. CHECKS & SERVICING EACH PART····· E – 5
4. GREASING EACH PART····· E – 15
5. STORING THE TRACTOR····· E – 16

F**TROUBLESHOOTING**

1. ENGINE TROUBLESHOOTING ····· F – 2
2. BRAKE TROUBLESHOOTING ····· F – 5
3. STEERING WHEEL TROUBLESHOOTING · F – 6
4. HYDRAULIC SYSTEM
TROUBLESHOOTING ····· F – 6
5. ELECTRIC INSTRUMENTS
TROUBLESHOOTING ····· F – 7

G**STANDARD FOR FARMWORK**

1. STANDARD FOR FARMWORK····· G – 2

H**APPENDIX**

1. SPECIFICATIONS ····· H – 2
2. MASS AND TIRE····· H – 4
3. NOISE LEVEL ····· H – 5
4. VIBRATION REFERRED TO THE OPERATOR
POSITION ····· H – 6
5. LAMPS AND FUSE····· H – 7
6. ENGINE EMISSION WARRANTY····· H – 8

TABLE OF CONTENTS

I INDEX

1. INDEX.....	- 2
---------------	-----



A. GENERAL INFORMATION

1. EXTERIOR VIEW ······ A – 2
2. TRACTOR IDENTIFICATION ······ A – 5
3. ABOUT THIS MANUAL ······ A – 6
4. INTRODUCTION & DESCRIPTION ······ A – 7
5. OWNER ASSISTANCE ······ A – 9
6. ROPS (ROLL OVER PROTECTIVE
STRUCTURES) ······ A – 10
7. SEAT ADJUSTMENT ······ A – 12

1. EXTERIOR VIEW

▶ RIGHT SIDE OF THE TRACTOR

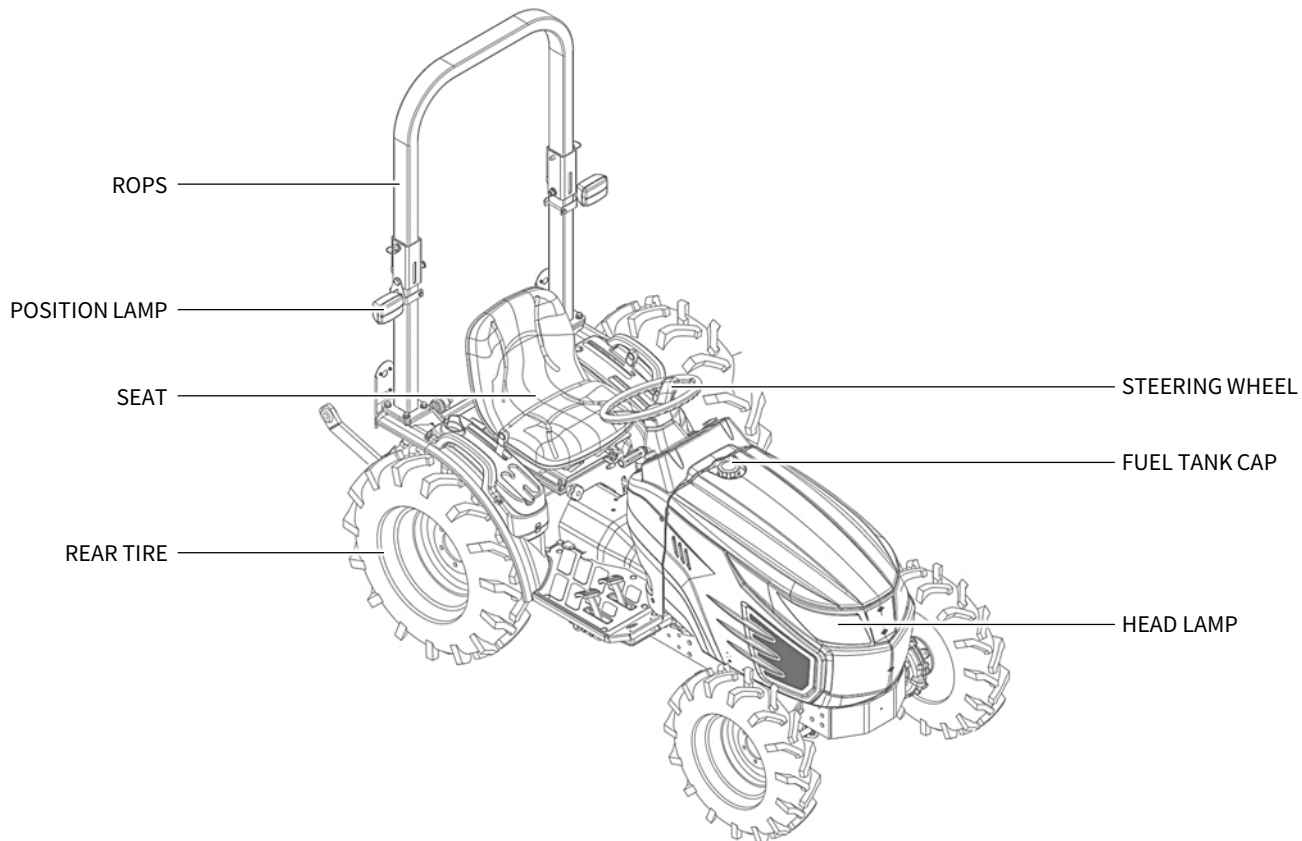

▶ LEFT SIDE OF THE TRACTOR

A

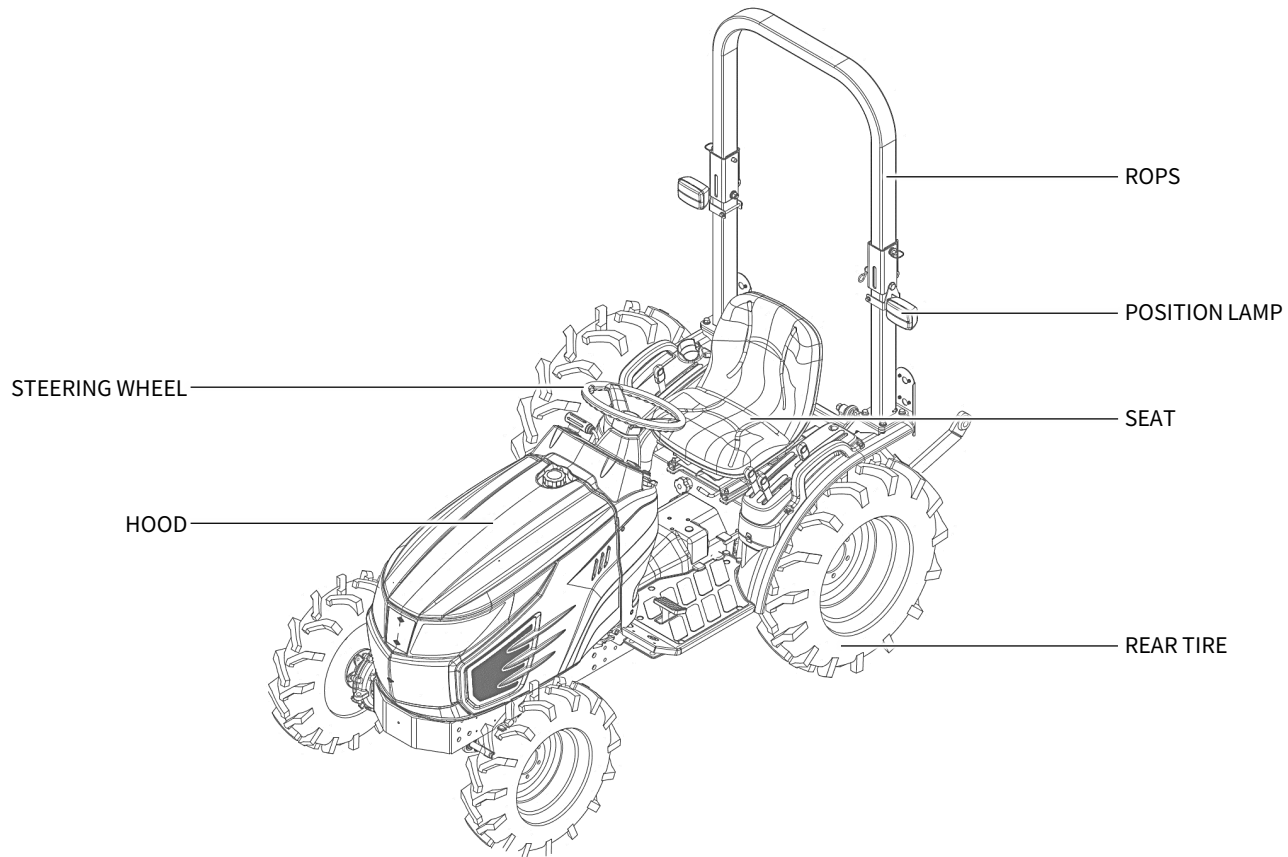

▶ **BACK SIDE OF THE TRACTOR**

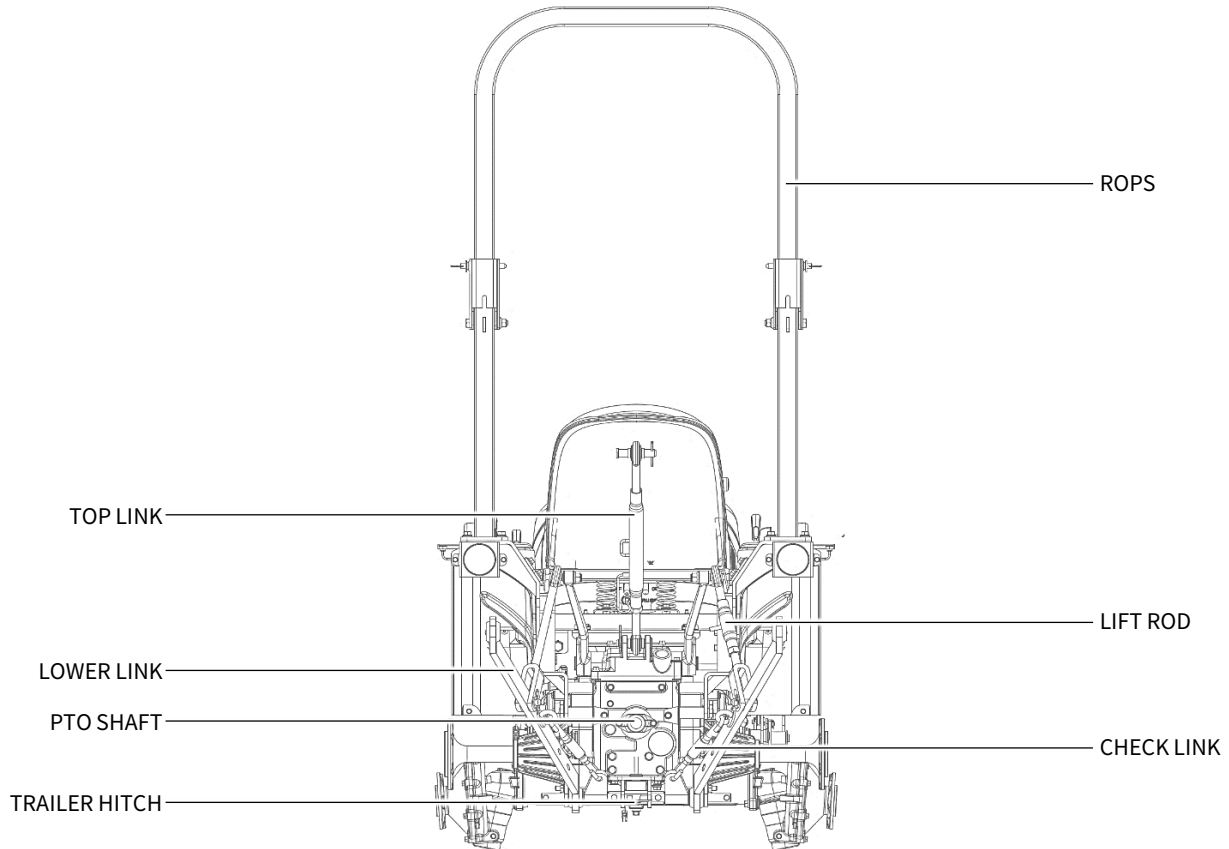

2. TRACTOR IDENTIFICATION

▶ TYPE OR NUMBER OF ENGINE & CHASSIS

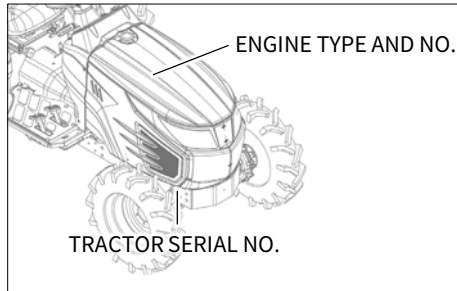

The engine and chassis number are stamped as shown in the drawing above.

▶ WARRANTY OF THE PRODUCT

The manufacturer warrants this product and full details of the warranty are provided on a separate warranty schedule.

▶ SERVICE & PARTS

• SERVICE

Service is available from any TYM dealer in the country.

• PARTS

To obtain spare parts please contact your nearest dealer and give him the details listed below.

- Tractor model
- Tractor serial number
- Tractor engine number
- Part number and description
- Quantity required



3. ABOUT THIS MANUAL

This manual has been prepared to assist you in following/adopting the correct procedure for running-in operation and maintenance of your new TYM CO., LTD tractor.

Your tractor has been designed and built to give maximum performance, with good fuel economy and ease of operation under a wide variety of operating conditions.

Prior to delivery, the tractor was carefully inspected, both at the factory and by your TYM Dealer/Distributor, to ensure that it reaches you in optimum conditions.

To maintain this condition and ensure trouble free performance, it is important that the routine services, as specified in this manual, are carried out at the recommended intervals.

Read this manual carefully and keep it in a convenient place for future reference. If at any time you require advice concerning your tractor, do not hesitate to contact your authorized TYM dealer / distributor.

He or she has trained personnel, genuine parts and necessary equipment to undertake all your service requirements.

Manufacturer's policy is one of continuous improvement, and the right to change prices, specifications or equipment at any time without notice is reserved.

All data given in this book is subject to production variations.

Dimensions & weight are approximate only and the illustrations do not necessarily show tractors in standard condition.

For exact information about any particular tractor, please consult your TYM dealer / distributor.

4. INTRODUCTION & DESCRIPTION

The word, 'tractor' has been derived from 'traction' which means pulling. A tractor is required to pull or haul an equipment, implement or trolley which are coupled to the tractor body through suitable linkage.

A tractor can also be used as a prime mover as it has a power outlet source which is also called Power Take or PTO shaft.

In this book the operating, maintenance and storage instructions for all models of TYM diesel tractors has been complied. This material has been prepared in detail to help you in the better understanding of maintenance and efficient operation of the machine.

If you need any information not given in this manual, or require the services of a trained mechanic, please get in touch with the TYM dealer / distributor in your locality.

Dealer / distributors are kept informed of the latest methods of servicing tractors.

They stock genuine spare parts and are backed by the company's full support.

Through this manual, the use of the terms LEFT, RIGHT, FRONT and REAR must be understood, to avoid any confusion when following the introductions.

The LEFT and RIGHT means left and right sides of the tractor when facing forward in the driver's seat, reference to the FRONT indicates the radiator end of the tractor, while the REAR, indicates the drawbar end.

When spare parts are required, always specify the tractor and engine serial number when ordering these parts. This will facilitate faster delivery and help ensure that the correct parts for your particular tractor is received.

The tractor serial number is punched on a plate attached to the left hand side of the engine body.

For easy reference, we suggest you to write the number in the space provided in the owner's personal data.

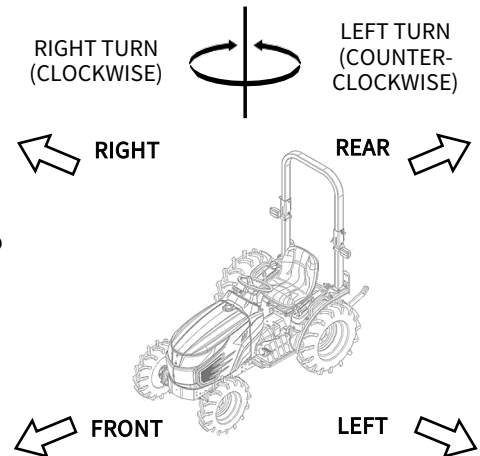



► DESCRIPTION

• GENERAL CONSTRUCTION

The transmission case, engine and front axle support are bolted together to form a rigid unit.

• FRONT AXLE & WHEEL

The 4WD front axle is a center-pivot, reverse eliot type.

The front wheel drive mechanism is incorporated as a part of the axle.

The front wheel drive power is taken off the rear transmission and transmitted to the differential in the front axle where the power is divided into right and left and to the respective final cases.

In the final cases, the transmitted revolution is reduced by the level gears to drive the front wheel.

The 4WD mechanism with level gears provides wider steering and greater durability.

• ENGINE

The tractors are fitted with vertical, water-cooled 3-cycle and spherical chamber type YANMAR ENGINES.

• CLUTCH & TRANSMISSION

The tractor is fitted with a 2 range HST. Speed range by a sub shift lever.

The tractor has two pedals for forward/reverse control.

Tractors with Independent Power Take Off are fitted with an electro-hydraulic clutch assy.

The rear PTO and mid PTO(option) can be operated together or separately by a lever.

• BRAKES

TYM tractors are provided with independent disc brakes operated by two brake rods' movement.

Use parking brake lever in case of parking the tractor.

• REAR AXLE & WHEELS

This is mounted on ball bearings and is enclosed in removable housing which are bolted to the transmission case.

The rim & disc fitted with rear tires are bolted to the outer flange of rear axle.

• HYDRAULIC SYSTEM & LINKAGES

TYM tractors are fitted with live independent, very touch of hydraulic system.

Three point linkages can be used for category 1 type of implements.

• STEERING

It consists of hydrostatic power steering system, which has a hydraulic cylinder and single type hydraulic pump.

5. OWNER ASSISTANCE

• ELECTRICAL SYSTEM

A 12 volt lead acid propylene battery is used to activate the engine through the starter motor and the electrical system comprising horn, head lamp.

Side indicator lamps, plough lamp, brake light, gauge lamp, hazard lamp. Generator or alternator, fuse box also from part of the electrical system.

WARNING

- When operating the tractor at high speed, do not attempt to make sharp turns by using the brakes. This may result in overturning of the tractor causing serious injury or death.

We at TYM and your TYM dealer / distributor want you to be completely satisfied with your investment.

Normally any problems with your equipment will be handled by your dealer / distributor's service departments, however, misunderstanding can occur.

If you feel that your problem has not been handled to your satisfaction, we suggest the following.

Contact the owner or general manager of the dealership, explain the problem, and request assistance.

When additional assistance is needed, your dealer / distributor has direct access to your office.

If you cannot obtain satisfaction by doing this, contact the TYM office and provide us with;

- Your name, address and telephone number
- Model and tractor serial number
- Dealer / distributor name & address
- Machine purchase date and Hours used
- Nature of problem

Before contacting TYM office, be aware that your problem will likely to be resolved in the dealership using the dealer's / distributor's facilities, equipment and personnel.

So it is important that your initial contact be with the dealer / distributor.



6. ROPS (ROLL OVER PROTECTIVE STRUCTURE)

► ROPS

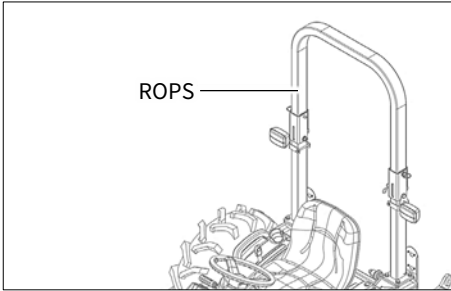

TYM tractors are equipped with a frame for the protection of operators. In the case of cab tractors the frame is incorporated in the cab structure. The objective of the frame or cab structure is to protect the operator in the event of a roll over and they are designed to support the entire weight of the tractor in that event.

Each TYM ROPS frame or cab structure is designed and has been tested to meet industry and or government standards. Included in these tests were all mounting bases and bolts or other fasteners.

On some models the ROPS frame has a fold down feature, which can be used to enter low buildings etc.

Take care when lowering the upper section of the ROPS frame and take extreme care while driving the tractor with the ROPS frame lowered.

Do not wear the seat belt with the ROPS lowered and please remember that the fold down facility is for special circumstances only and must not be lowered for general use.

DANGER

- For ROPS frames to be effective and protect the operator, the seat belt provided must be worn in order to keep operators within the ROPS protected area in the event of a roll over. Failure to use the seat belt can still cause serious injury or death.

► USE OF TRACTOR WITH ROPS LOWERED CAN CAUSE FATAL INJURIES

As the ROPS frame or cab together with the seat belt was designed to meet certain standards, they must be maintained in good order and condition. To achieve this objective, both the structure and the seat belt should be inspected on a regular basis. (Every time the tractor is serviced)

In the event that the seat belt is damaged or frayed, it should be replaced and in the event that the ROPS frame or any part of the mounting structure is damaged or cracked, the faulty component must be replaced with a new unit.

Such a unit must meet all of the test criteria of the original unit. Fitment of an inferior item or items affects the certification of the entire ROPS structure and the effectiveness of the structure in the event of an accident. Drilling or welding of the ROPS is forbidden.

► **DAMAGE OF ROPS**

If the tractor has rolled over or the ROPS has damaged (such as striking an overhead object during transport), it must be replaced to provide the original protection.

After an accident, check for damages to

- **ROPS**
- **SEAT**
- **SEAT BELT & SEAT MOUNTINGS**

Before you operate a tractor, replace all damaged parts.

 **WARNING**

- Do not weld, drill or straighten the ROPS.
- Always wear your seat belt if the tractor is equipped with ROPS.

 **WARNING**

- If the ROPS is removed or replaced, make certain that the proper hardware is used to replace the ROPS and the recommended torque values are applied to the attaching bolts.

 **WARNING**

- Never attach chains, ropes to the ROPS for pulling purposes. This will cause the tractor to tip backwards. Always pull from the tractor drawbar.
- Be careful when driving through door opening or under low overhead objects. Make sure there is sufficient overhead clearance for the ROPS fatal injuries.

► **ROPS TYPE**

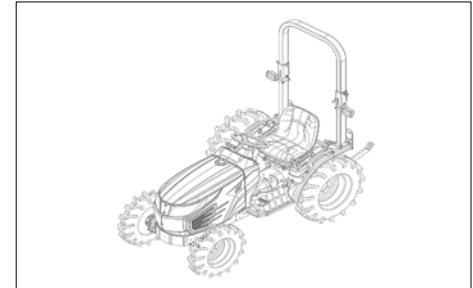

A

7. SEAT ADJUSTMENT

▶ SEAT SLIDING

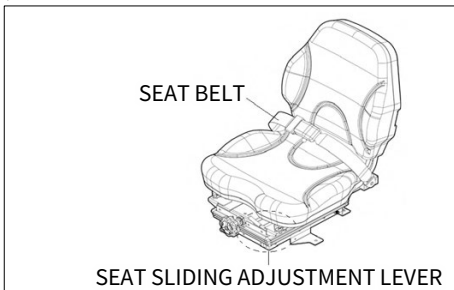

Before operating a tractor it is important to adjust the seat to the most comfortable position & check whether it is properly locked in its position.

⚠ IMPORTANT

- Do not use solvents to clean the seat. Use warm water with a little detergent added.

⚠ WARNING

- Do not put a hand between the seat and the slides when adjusting the seat position. You can get injured unexpectedly.

To select seat position, move adjusting lever and slide seat closer to or away from dash panel and controls.

⚠ DANGER

- Check whether the seat properly locked in its position before driving the tractor.
- Always use the seat belt when the ROPS is installed.
- Do not use the seat belt if a foldable ROPS is down or there is no ROPS. Check the seat belt regularly and replace if frayed or damaged.

▶ CUSHION STRENGTH ADJUSTMENT

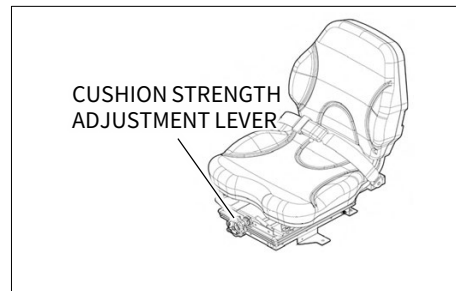

The seat cushion can be adjusted according to the weight of the driver.

Turning the cushion adjustment lever counterclockwise to the 50kg position makes the cushion lighter, and turning the lever clockwise to the 130kg position makes the cushion heavier.

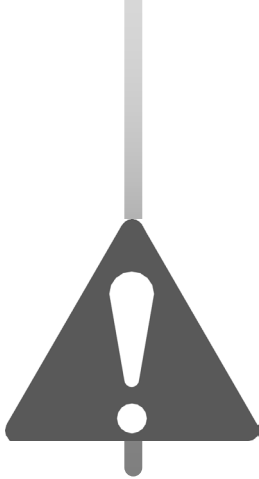

B. SAFETY PRECAUTIONS

1. SAFETY INSTRUCTIONS B – 2
2. SAFE OPERATION OF TRACTOR B – 15
3. DOs & DON'Ts B – 22
4. SAFETY DECALS B – 24
5. UNIVERSAL SYMBOLS B – 29

SAFETY PRECAUTIONS

1. SAFETY INSTRUCTIONS

► ENSURE SAFETY INFORMATION



This symbol means

‘Attention! Your safety is involved.’

The message that follows the symbol contains important information about safety.

Carefully read the message.

► SIGNAL SIGNS



The signal signs

‘DANGER, WARNING or CAUTION’

are used with safety alert symbol.

DANGER identifies the most serious hazards.

Safety symbols with signal signs ‘DANGER or WARNING’ are typically near specific hazards.

General precautions are listed on CAUTION safety signs.

► READ SAFETY INSTRUCTION

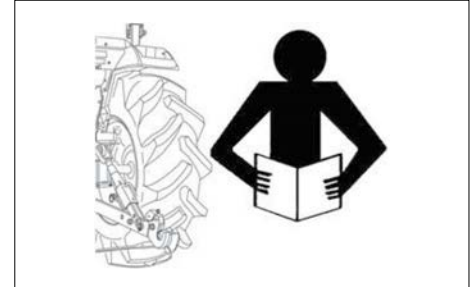

Carefully read all safety instructions given in this manual for your safety.

Tempering with any of the safety devices can cause serious injuries or death.

Keep all safety signs in good condition. Replace missing or damaged safety signs.

Keep your tractor in proper condition and do not allow any unauthorized modifications to be carried out on the tractor, which may impair the function / safety and affect tractor life.

► PROTECT CHILDREN

Keep children and others away from the tractor while operating.

Before you reverse

- Look behind tractor for children.
- Do not let children to ride on tractor or any implement.

► USE OF ROPS AND SEAT BELT

The Roll Over Protective Structure (ROPS) has been certified to industry and / or government standard.

Any damage or alternation to the ROPS, mounting hardware or seat belt voids the certification and will reduce or eliminate protection for the operator in the event of a roll-over.

The ROPS, mounting hardware and seat belt should be checked after the first 100 hours of use and every 500 hours thereafter for any evidence of damage, wear or cracks.

In the event of damage or alternation, the ROPS must be replaced prior to further operation of the tractor.

The seat belt must be worn during machine operation when the machine is equipped with a certified ROPS.

Failure to do so will reduce or eliminate protection for the operator in the event of a roll-over.

▶ PRECAUTION TO AVOID TIPPING

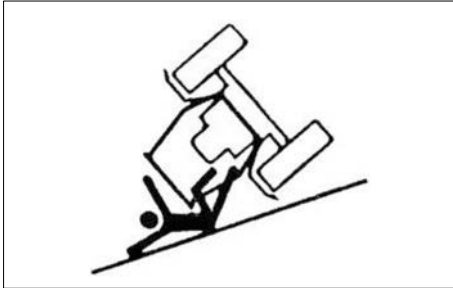

Do not drive where the tractor could slip or tip.
Stay alert for holes and rocks in the terrain and other hidden hazards.

Slow down before you make a sharp turn.

Driving forward out of a ditch or mired condition could cause tractor to tip over backward.

Back out of these situations if possible.

▶ PARK TRACTOR SAFELY

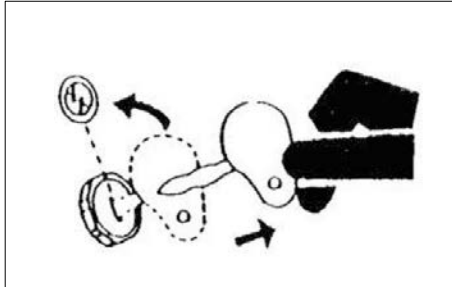

Before working on the tractor:

- Lower all equipment to the ground.
- Stop the engine and remove the key.

▶ KEEP RIDERS OFF TRACTOR



Do not allow riders on the tractor.

Riders on tractor are subject to injury such as being stuck by foreign objects and being thrown off of the tractor.

▶ HANDLE FUEL SAFELY TO AVOID FIRE



Handle fuel with care.
It is highly flammable.

Do not refuel the tractor while smoking or near open flame or sparks.

Always stop engine before refueling tractor.

Always keep your tractor clean of accumulated grease and debris.
Always clean up spilled fuel.

▶ STAY CLEAR OF ROTATING SHAFTS



Entanglement in rotating shaft can cause serious injury or death.

Keep PTO shield in place at all the time.

Wear fitting clothing.

Stop the engine and be sure PTO drive is stopped before making adjustments, connections or cleaning out of PTO driven equipment.

▶ ALWAYS USE SAFETY LIGHTS AND DEVICES

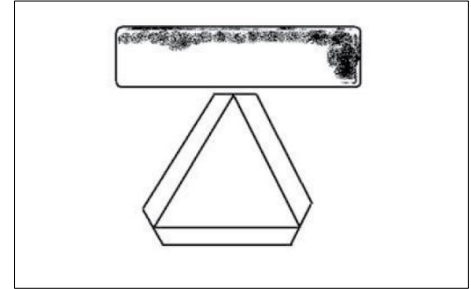

Use of hazard warning lights and turn signals are recommended when towing equipment on public roads unless prohibited by state or local regulations.

Use slow moving vehicle(SMV) sign when driving on public road during both day& night time unless prohibited by law.

► PRACTICE SAFE MAINTENANCE



Understand service procedure before doing work.

- Keep the surrounding area of the tractor clean and dry.
- Do not attempt to service tractor when it is in motion.
- Keep body and equipment to the ground.
- Stop the engine.
- Remove the key.
- Allow tractor to cool before any work repair is caused on it.
- Securely support any tractor elements that must be raised for service work.

- Keep all parts in good condition and properly installed.
- Replace worn or broken parts.
- Replace damaged / missing decals.
- Remove any build-up of grease or oil from the tractor.
- Disconnect battery ground cable ⊖ before making adjustments on electrical systems or welding on tractor.

► AVOID HIGH PRESSURE FLUIDS



Escaping fluid under high pressure can penetrate the skin causing serious injury.

Keep hands and body away from pin holes and nozzle which eject fluids under high pressure.

If any fluid is injected into the skin, consult your doctor immediately.

▶ PREVENT BATTERY EXPLOSION

Keep sparks, lighted matches and open flame away from the top of battery. Battery gas can explode.

Never check battery charge by placing a metal object across the poles.

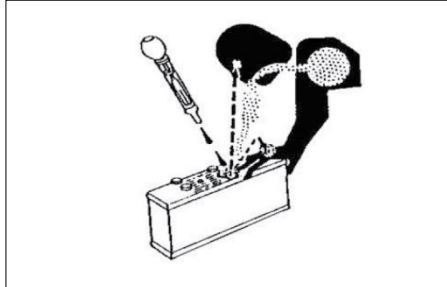
▶ PREVENT ACID BURNS

Sulfuric acid in battery electrolyte is poisonous. It is strong enough to burn skin, cause holes in clothing and cause blindness if found entry into eyes.

For adequate safety always:

- Fill batteries in a well-ventilated area.
- Wear eye protection and acid proof hand gloves.
- Avoid breathing direct fumes when electrolyte is added.
- Do not add water to electrolyte as it may splash off causing severe burns.

If you spill acid on yourself:

1. Flush your skin or eyes with water for 10 ~ 15 minutes.
2. Get medical attention immediately.

▶ BATTERY DISCONNECTION

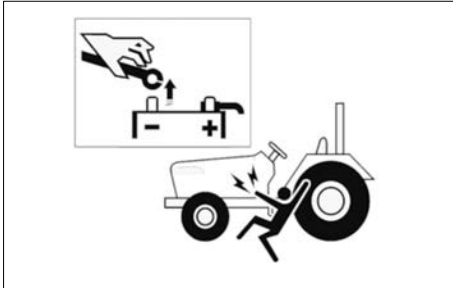

When working with your tractor electrical components, you must first disconnect the battery cables.

To ensure that there are no accidents from sparks, you must first disconnect the negative battery cable.

▶ SERVICE TRACTOR SAFELY

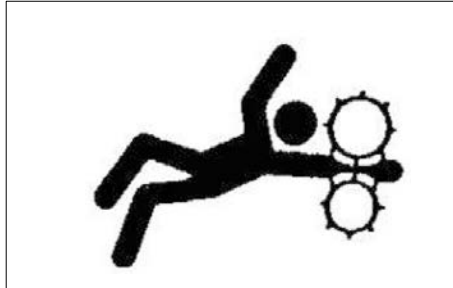

Do not wear a necktie, scarf or loose clothing when you work near moving parts.

If these items were to get caught, severe injury could result.

Remove rings and other jewelry to prevent electrical shorts and entanglement in moving parts.

▶ WORK IN VENTILATED AREA

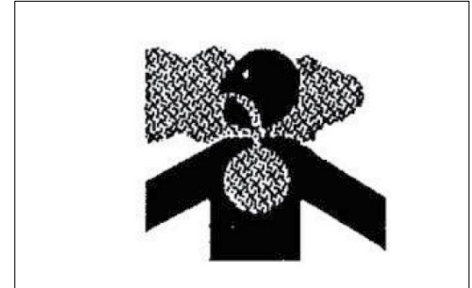

Do not start the tractor in an enclosed building unless the doors & windows are open for proper ventilation as tractor fumes can cause sickness or death.

If it is necessary to run an engine in an enclosed area remove the exhaust fumes by connecting exhaust pipe extension.

▶ TRACTOR RUNAWAY

Engine start with transmission engaged can cause tractor to runaway resulting serious injury to the people standing nearby the tractor.

For additional safety keep the pull to stop knob (fuel shut off control) in fully pulled out position.

Transmission in neutral position, foot brake engaged and PTO lever in disengaged position while attending to Safety Starter Switch or any other work on tractor.

▶ SAFETY START

Safety Starter switch for starting is provided on transmission main or sub shift lever and in PTO shift lever.

The tractor can be started only if main or sub shift lever is in neutral position.

CAUTION

- Safety Starter Switch is to be replaced after every 2,000 hours/4 years, whichever is earlier.

▶ EMERGENCY EXITS

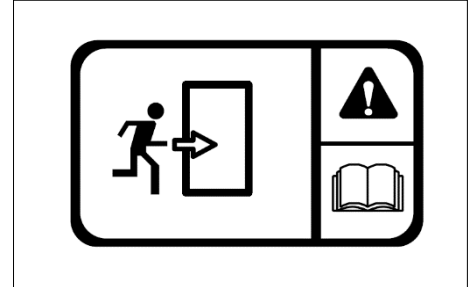

If exit from the cab side doors is blocked (following an accident or vehicle overturn) the alternative safety exits are indicated by decals.

The possible safety exits are:

- Rear window hatch (All tractors)
- Front window (for versions with openable front window).

► SAFETY PRECAUTIONS WHEN USING LOADER

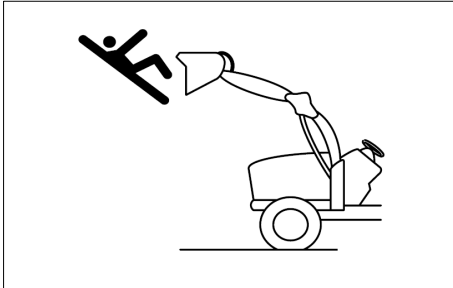

Never let anyone get in the loader and use the loader as a workbench. Otherwise, it may lead to a fatal injury or even death.

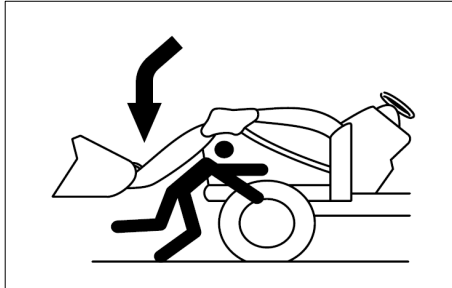

Do not stand under the lifted loader or get close to it. Also, lower the loader arm onto the ground before leaving the tractor. Otherwise, it may lead to a fatal injury or even death.

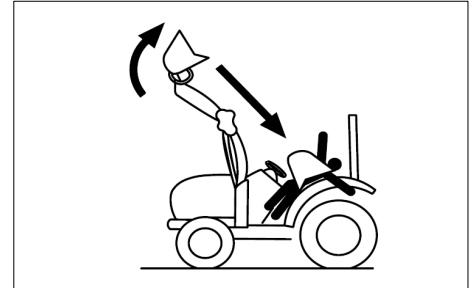

When attaching or detaching the loader, fix all parts which are connected to the bucket and boom. The bucket or boom can be accidentally dropped down, leading to an injury or even death.

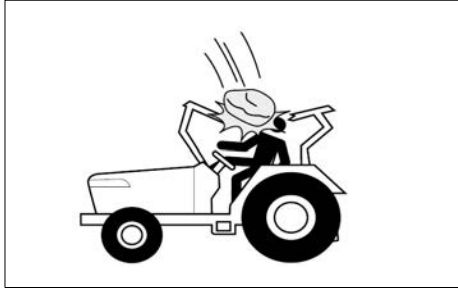

Be careful of objects falling from loader.

+ **IMPORTANT**

- ROPS (Roll Over Protective Structure), sun canopy or cabin are not a FOPS (Falling Object Protective Structure). It never can protect the riders against falling objects. Avoid driving the vehicle into a dangerous area such as falling rocks zone.

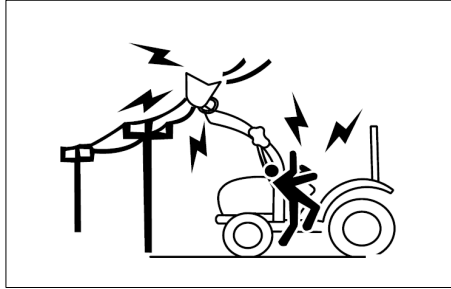

Do not allow loader arms or attachment to contact electrical power lines. Electrocutation will cause serious injury or death.

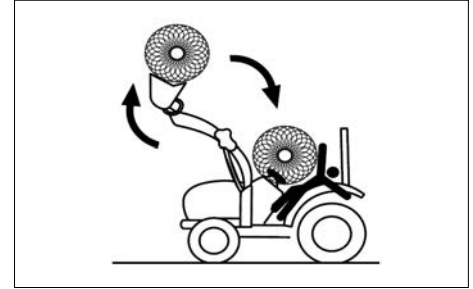

Never carry a big object with the loader unless a proper implement is attached.

Keep a carried object low during driving.

Otherwise, it may lead to an injury or even death.

► **TOWING SAFELY**

For the maximum towable loads, refer to the 'TIRE AND MASS' section in appendix chapter if available.

Maintain a suitable speed taking into account the weight of the trailed load and the gradient, remembering that braking distances will be greater than with just the tractor.

Trailed loads with or without brakes that are too heavy for the tractor or that towed at too high speed may cause the operator to lose control of the tractor.

Always take into consideration the total weight of the implements and their loads.

 **CAUTION**

- Before you leave the driving seat when a trailer is hitched to the tractor, remember to put all the controls in neutral, apply the parking brake, switch off the engine, engage first gear (if the tractor has a mechanical transmission) and remove the key from the starter switch.
If the tractor is not parked on level ground, always place chocks under the wheels of both the tractor and the trailer.

► **TRANSPORT TRACTOR BY TRUCK**

Always secure the tractor to the loader bed with chains.

Before transporting the tractor on a low loader or on a railway wagon, make sure that the engine hood, doors, openable roof (if present) and windows are all closed and securely fastened.

Never tow the tractor at speeds in excess of 10km/h.

An operator must stay in the operator position to steer and brake the tractor.

► FALLING OBJECT PROTECTIVE STRUCTURE (FOPS)

The term FOPS refers to structure installed on the tractor intended to reduce the risk to the operator of injury from falling objects during normal use of the vehicle

⊕ IMPORTANT

- This tractor is not equipped with a FOPS.
- The energy level of drop test is 1365J.

► OPERATOR PROTECTIVE STRUCTURE (OPS)

The term OPS refers to a protective structure installed on a tractor in order to minimize risk of operator injury caused by objects penetrating into the operator position area.

⚠ DANGER

- This tractor is not equipped with an OPS. If work must be performed in areas subject to the risk of the penetration of objects into the operator position, consult your dealer before starting work so that the tractor can be equipped with an appropriate protective structure.

► USE OF HAZARDOUS SUBSTANCES

European standard EN 15695-1 is applicable to the cabs of agricultural or forestry tractors and self-propelled sprayers.

The purpose of the standard is to limit the exposure of the operator (driver) to hazardous substances when applying plant protection products and liquid fertilizers.

In accordance with the stipulations of EN 15695-1 regarding cab classification, measurement of the internal positive pressure differential must be carried out in conformance with ISO 14269-5:

- The engine operating at nominal speed;
- The maximum quantity of air drawn from outside the cab (recirculation closed);
- Fan set to maximum speed.

The following terms and definitions are applied:

- Hazardous substances: substances such as dust, vapours and aerosols, with the exception of fumigants which can be dispersed during the application of plant protection products and liquid fertilizers, which may have a harmful effect on the operator.
- Dust general term identifying solid air-borne particles, finely divided and accumulated.
- Aerosol: suspension of solid, liquid or solid and liquid particulate in a gaseous medium with a negligible fall rate (generally less than 0.25 ms⁻¹)
- Vapour: gaseous phase of a substance whose liquid or solid state is stable at 20°C and 1 bar (absolute).
This cab, even when closed, does not protect against the inhalation of hazardous substances.

If the manufacturer's instructions for using these substances recommend personal protective equipment, wear the equipment even in the cab.

Cabs are classified as follows:

- Category 1: the cab does not provide protection against hazardous substances.
- Category 2: the cab provides protection exclusively from dust.
- Category 3: the cab provides protection from dust and aerosol.
- Category 4: the cab provides protection from dust, aerosol and chemical vapours.

The classification category, as stipulated

by ISO 14269-5, of the cab installed on this range of tractors is given below:

- the engine operating at nominal speed
- the maximum quantity of air drawn from outside the cab (recirculation closed) with fan at maximum speed.

Table 2 – Technical data

	CATEGORY
ROPS / CABIN Hazardous substances protection category	1

DANGER

- Use all the personal protective equipment suitable for the tasks in hand and relative substances, in compliance with the requirements of statutory legislation in your country.

2. SAFE OPERATION OF YOUR TRACTOR

The manufacturer of your tractor has made every effort to make it as safe as is humanly possible.

Beyond this point it is the responsibility of the operator to avoid accidents and we ask that you read and implement our suggestions for your safety.

Ensure that only trained and competent operators use this tractor and ensure that they are fully conversant with the machine and aware of all its control and safety features.

Operators should not operate the tractor or associated machinery while tired or untrained.

To avoid accidents please ensure that the operator wears clothing which will not get entangled in the moving parts of the tractor or machine and protect him or her from the elements.

When spraying or using chemicals, please ensure that clothing and protective equipment is worn which prevents respiratory or skin problems.

For full details consult the manufacturer of the chemicals.

To avoid lengthy exposure to noise ensure that ear protection is worn.

If adjustment to the tractor or machinery need to be made ensure the tractor or machine are turned off beforehand.

Use of certified Roll Over Protection Structure (ROPS) is a must while operating a tractor.

Use of seat belt is a must while operating a tractor.

In summary, ensure at all times that the safety of the operator and any other worker is paramount.

Ensure no one is between the tractor and a towed vehicle (trailer or implement).

► SAFETY TIPS DURING MAINTENANCE

1. At least on a daily basis check all oil levels. Water level in the radiator and electrolyte level in the battery and perform services according to the service schedule.
2. Ensure tire pressure are even and the correct pressure for the job being done is maintained.
3. Check to ensure that the all controls and preventative mechanisms of the tractor and implement work correctly and effectively.
4. Ensure that an adequate set of the correct tools is available for maintenance and minor repairs.
5. Ensure that all service work and repairs are carried out on a flat area with a concrete or similar floor. Do not carry out service work on a tractor until it is switched off, and the parking brake applied and wheels chocked. Where a tractor is started in a confined area, ensure that the area is well ventilated as exhaust gases are very harmful, and can cause death.
6. Do not work under raised implements.
7. When changing wheels or tires ensure that a suitable wheel stand is placed under the axle prior to removing the wheel and the wheels are chocked.
8. Where guards or shields need to be removed to perform a service or repair, ensure that the guard or shield is correctly reinstalled before starting the tractor.
9. Never refuel near a naked flame or with an overheated engine. Ensure to turn off Engine before refueling.
10. The cooling system operates under pressure, take care when removing the radiator cap on a hot engine to prevent being scalded by steam or hot water. Do not add water in the radiator when the engine is hot. Add water to the radiator only after the engine cools down completely.
11. To prevent fires keep the tractor including the engine clean and free from inflammable material and well away from fuels and other inflammable material.

► MOUNTING AND DEMOUNTING IMPLEMENTS

1. Ensure that all mounting and removal of implements is done on safe flat ground. Ensure no one is between the tractor and implement and do not get under the implement to avoid accidental injuries.
2. After mounting the implement, ensure that all sway chains are correctly adjusted and, where PTO shafts are used that the shaft is fitted and secured correctly.
3. Where heavy implements are used, ensure that the combination is well balanced or use proper ballast to achieve balance.
4. Before leaving the tractor at any time, lower the implement, stop the PTO shaft where applicable, set the parking brake and switch off the engine.
5. While operating the implements with the PTO keep all bystanders away from any moving parts and do not attempt to make adjustments while the machine is running.
6. Only the driver should ride on the tractor with the ROPS frame fitted and with the seat belt properly fastened.
7. Where young children are present, particular care should be taken and the tractor should not be moved until the whereabouts of all children is known.
8. Only trained operators should operate the tractor and so taking care to ensure that other workers are not injured. In particular they should take care during dusty operations, which will reduce visibility substantially.
9. Never start the tractor unless the transmission is out of gear, the operator is in the seat and all round safety has been checked.
10. Only operate the tractor seated in the driver's seat and never turn or brake suddenly at high speed as this can cause a roll-over and serious injury or death.
11. When traveling on a public road ensure that the tractor and driver both meet all laws relating to safety and licensing. When traveling with wide implements use red flags on the extremities and observe all legal including escort requirements.
12. When operating under adverse conditions, hilly terrain or on bad ground adjust the speed of the tractor to suit the conditions, safety

comes first.

Never drive down-hill at high speed or with the transmission in neutral. Use of the braking capacity of the engine as well as the service brakes. Do not try to change gear going up or down a steep slope, select the correct gear before starting.

13. Take care when traveling uphill with a heavy implement to ensure that it does not overbalance and tip up the front end.
14. Never remove or modify the seat belt.
15. Never remove, modify or repair the ROPS frame.

Please remember that a little bit of extra care can prevent serious injury or death and avoid damage to your tractor.

► THE FOLLOWING PRECAUTIONS ARE SUGGESTED TO HELP PREVENT ACCIDENTS

A careful operator is the best operator. Most accidents can be avoided by observing certain precautions. Read and take the following precautions before operating the tractor to prevent accidents. Tractor should be operated only by those who are responsible and properly trained to do so.

<THE TRACTOR>

1. Read the operator's manual carefully before using the tractor. Lack of operating knowledge can lead to accidents.
2. Use an approved rollover bar and seat belt for safe operation. Overturning of a tractor without a rollover bar can result in death or injury.
3. Do not remove ROPS (Roll Over Protective Structure). Always use the seat belt.
4. Fiberglass canopy does not give any

protection.

5. To prevent falls, keep steps and platform clear of mud and oil.
6. Do not permit anyone but the operator to ride on the tractor. There is no safety place for extra riders.
7. Replace all missing, illegible or damaged safety signs.
8. Keep safety signs clean of dirt and grease.

<SERVICING THE TRACTOR>

1. keep the tractor in good operating condition for your safety. An improperly maintained tractor can be hazardous.
2. Stop the engine before performing any service on the tractor.
3. The cooling system operates under pressure, which is controlled by the radiator cap. It is dangerous to remove the cap while the system is hot.

First turn the cap slowly to stop and allow the pressure to escape before removing the cap entirely.

4. Do not smoke while the refueling the tractor.
Keep away any type of open flame.
5. The fuel in the injection system is under high pressure and can penetrate the skin.
Unqualified persons should not remove or attempt to adjust a pump, injector, nozzle or any part of the fuel injection system.
Failure to follow these instructions can result in serious injury.
6. Keep open flame away from battery or cold weather starting aids to prevent fire or explosions.
7. Do not modify or alter or permit anyone else to modify or alter this tractor or any of its components or any tractor functions.

<OPERATING THE TRACTOR>

1. Before starting the tractor apply the parking brake, place the PTO (Power Take Off) lever in the “OFF” position, the position control levers in the downward position, the hydraulic control levers in the neutral position (If fitted) and the transmission in neutral.
2. Do not start the engine or controls while standing beside the tractor. Always sit on the tractor seat when the engine or operating controls.
3. Safety start:
In order to prevent the accidental starting of the tractor, a safety switch has been provided. The starting system of the tractor is connected through this switch. On some models shuttle shifter lever and PTO button should also be in neutral position for completing the starting circuit. Do not bypass the safety switch. Consult your TYM tractor

distributor / dealer if safety switch malfunctions.

4. Avoid accidental contact with the gear shifter lever while the engine is running.
Unexpected tractor movement can result from such contact.
5. Do not get off or climb the tractor while it is in motion.
6. Shut off the engine, remove the key and apply the parking brake before getting off the tractor.
7. Do not operate the tractor in an enclosed building without adequate ventilation.
Exhaust fumes can cause death.
8. Do not park the tractor on a steep slope.
9. If power steering or Engine seizes to operate, stop the tractor immediately.
10. Pull only from the swinging draw bar or the lower link drawbar in the down position. Use only a drawbar pin that locks in place.

Pulling from the tractor rear axle carriers or any point above the rear axle may cause the tractor's front end to lift.

11. If the front end of the tractor tends to rise when heavy implements are attached to the three point linkage, install front end or front wheel weights.
Do not operate the tractor with a light front end.
12. Always use hydraulic position control lever when attaching equipment / implement and when transporting equipment.
Be sure that the hydraulic couplers are properly mounted and will disconnect safely in case of accidental detachment of implement.
13. Do not leave equipment/implement in the raised position.
14. Use the flasher / turn signal lights and Slow Moving Vehicle (SMV) signs when driving on public roads

during both day and night time, unless prohibited by law.

15. Dim tractor lights when meeting a vehicle at night.
Be sure the lights are adjusted to prevent the blinding on the eyes of coming vehicle operator.
16. Emergency stopping instruction; If tractor fails to stop even after application of brakes.
Pull the knob of fuel shut off control rod.

<DRIVING THE TRACTOR>

1. Watch where you are going especially at row ends, on roads, around trees and low hanging obstacles.
2. To avoid upsets, drive the tractor with care and at speeds compatible with safety, especially when operating over rough ground, crossing ditches or slopes, and when turning at corners.

3. Lock the tractor brake pedals together when transporting on roads to provide proper wheel braking.
4. Keep the tractor in the same gear when going downhill as used when going uphill.
Do not coast or free wheel down hills.
5. Any towed vehicle and/or trailer whose total weight exceeds that of the towing tractor, must be equipped with its own brakes for safe operation.
6. When the tractor is stuck or tires are frozen to the ground, back out to prevent upset.
7. Always check overhead clearance, especially when transporting the tractor.

<OPERATING THE PTO>

1. When operating PTO driven equipment, shut off the engine and wait until the PTO stops before getting off the tractor and disconnecting the equipment.
2. Do not wear loose clothing when operating the power take-off or near rotating equipment.
3. When operating stationery PTO driven equipment, always apply the tractor parking brake and block the rear wheels from front and rear side.
4. To avoid injury, always move down flip part of PTO.
Do not clean, adjust or service PTO driven equipment when the tractor engine is running.
5. Make sure the PTO master shield is installed at all times and always replace the PTO shield cap when the PTO is not in use.

<DIESEL FUEL>

1. Keep the equipment clean and properly maintained.
2. Under no circumstances should gasoline, alcohol or blended fuels be added to diesel fire or explosive hazard.
Such blends are more explosive than pure gasoline. In a closed container, such as a fuel tank. DO NOT USE THESE BLENDS.
3. Never remove the fuel cap or refuel the tractor with the engine running.
4. Do not smoke while refueling or when standing near fuel.
5. Maintain control of the fuel filler pipe when filling the tank.
6. Do not fill the fuel tank to capacity. Allow room for expansion.
7. Wipe up spilled fuel immediately.
8. Always tighten the fuel cap securely.
9. If the original fuel tank cap is lost, replace it with genuine cap. A none approved cap may not be safe.

10. Do not drive equipment near open fire.
11. Never use fuel for cleaning purpose.
12. Arrange fuel purchases so that winter grade fuel are not held over and used in the spring.
13. Use ultra-low sulfur fuel only.

 IMPORTANT

- It is suggested that after repairs if any of the safety decals or signs are peeled or defaced, the same may be replaced immediately in interest of your safety.

SAFETY PRECAUTIONS

3. DOs & DON'Ts

► DOs – FOR BETTER PERFORMANCE

- DO** - Ensure that safety shields are in place and in good condition.
- DO** - Read all operating instructions before commencing to operate tractor.
- DO** - Carry out all maintenance tasks without fail.
- DO** - Keep the air cleaner clean.
- DO** - Ensure that the correct grade of lubricating oils is used and that they are replenished and changed at the recommended intervals.
- DO** - Fit new sealing rings when the filter elements are changed.
- DO** - Watch the oil pressure gauge or warning light and investigate any abnormality immediately.
- DO** - Keep the radiator filled with clean water and in cold weather use anti-freeze mixture. Drain the system only in an emergency and fill before starting the engine.
- DO** - Ensure that the transmission is in neutral before starting the engine.
- DO** - Keep all fuel in clean storage and use a filter when filling the tank.
- DO** - Attend to minor adjustments and repairs as soon as necessity is apparent.
- DO** - Allow the engine to cool before removing the radiator filler cap and adding water, remove the radiator cap slowly.
- DO** - Shift into low gear when driving down steep hills.
- DO** - Latch the brake pedals together when driving on a highway.
- DO** - Keep draft control lever fully down when not in use.

► DON'Ts – FOR SAFE OPERATION

DON'T - Run the engine with the air cleaner disconnected.

DON'T - Start the tractor in an enclosed building unless the doors and windows are open for proper ventilation.

DON'T - Operate the tractor or engine while lubricating or cleaning.

DON'T - Allow the tractor to run out of diesel fuel otherwise it will be necessary to vent the system.

DON'T - Temper the fuel injection pump, if seal is broken the warranty becomes void.

DON'T - Allow the engine to run idle for a long period.

DON'T - Run the engine if it is not firing on all cylinders.

DON'T - Ride the brake.

This will result in excessive wear of the brake lining.

DON'T - Use the independent brakes for making turns on the highway or at high speeds.

DON'T - Refuel the tractor with the engine running.

DON'T - Mount or dismount from the right side of the tractor.

DON'T - Temper the hydraulic control levers' upper limit stops.

DON'T - Use draft control lever for lifting of implements.

DON'T - Start the engine with the PTO engaged.

DON'T - Use the throttle lever while driving on roads.

DON'T - Move the hydraulic levers rearward.

4. SAFETY DECALS

► GENERAL INFORMATION OF DECALS

- In order to work with the machine safely, safety decals should be placed on the machine.
- Make sure to read and follow the following directions.

■ **KEEP THE WARNING LABELS CLEAN AND NOT DAMAGED AT ALL TIMES.**

If a decal on the machine is dirty, wash it with soapy water and wipe it off with a soft cloth. Never use solution such as thinner or acetone because these can erase characters or pictures.

■ **IF WASHED WITH HIGH PRESSURED WATER, A DECAL MAY BE PEELED OFF.**

Do not apply high pressured water directly onto decals.

■ **IF A SAFETY DECAL IS DAMAGED OR LOST, ORDER A NEW ONE IMMEDIATELY AND PLACE IT ON THE MACHINE.**

When putting a new decal, wipe off the place to post the decal thoroughly and wait till it is dried. Then post the decal.
Each decal has a part number on the bottom.

■ **WHEN REPLACING A PART ATTACHED WITH A DECAL WITH A NEW PART, REPLACE THE DECAL AS WELL.**

► **DECALS ON CHASSIS**

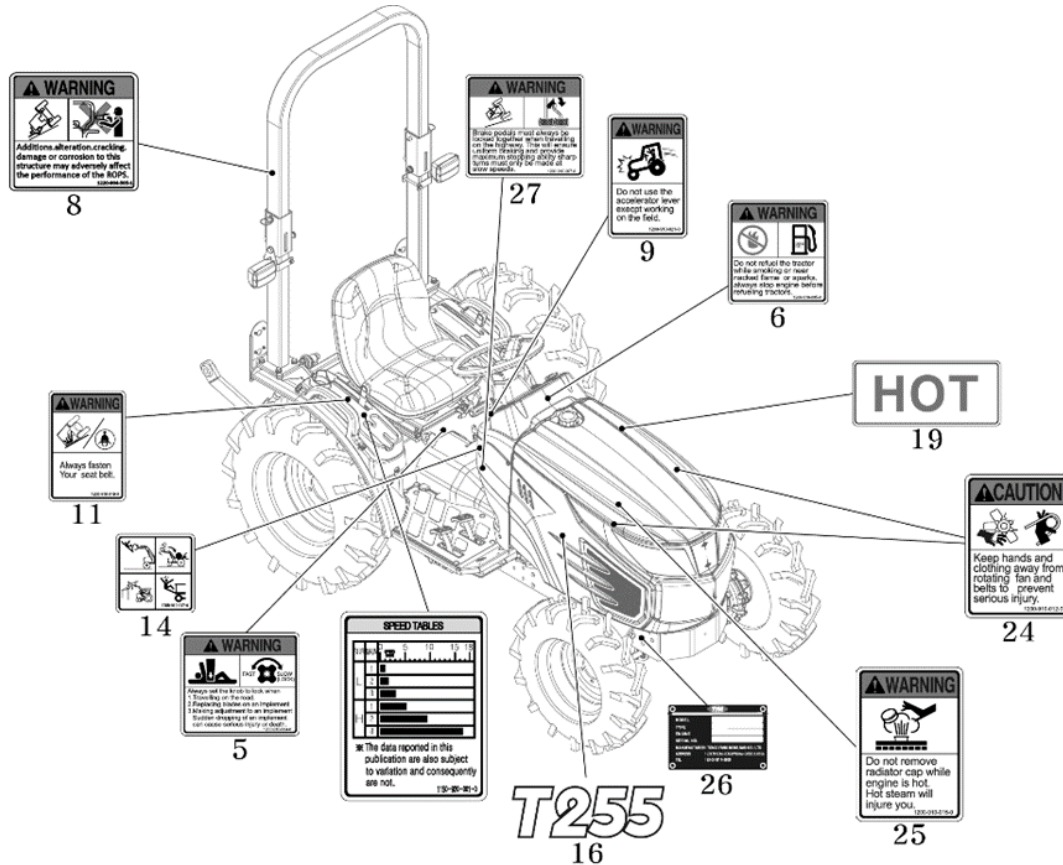

WARNING



Additional abrasion, cracking, damage or corrosion to this structure may adversely affect the performance of the ROPS.

8

WARNING



Always use the PTO always be engaged together when loading on the highway. The use of reverse idler may not be made at any speed.

27

WARNING



Do not use the accelerator lever except working on the field.

9

WARNING



Do not refuel the tractor while standing or near parked farm or spools. Always stop engine before refueling tractor.

6

HOT

19

WARNING



Always fasten Your seat belt.

11

WARNING



14

WARNING



Always use the PTO to lock when:
1. Working on the road.
2. Disengaging clutch on an implement.
3. Making adjustments to an implement.
4. After changing of an implement.
5. At other times when necessary.

5

SPEED TABLES

Gear	1	2	3	4	5	6	7	8	9	10	11
1st	0-10	0-10	0-10	0-10	0-10	0-10	0-10	0-10	0-10	0-10	0-10
2nd	0-10	0-10	0-10	0-10	0-10	0-10	0-10	0-10	0-10	0-10	0-10
3rd	0-10	0-10	0-10	0-10	0-10	0-10	0-10	0-10	0-10	0-10	0-10
4th	0-10	0-10	0-10	0-10	0-10	0-10	0-10	0-10	0-10	0-10	0-10
5th	0-10	0-10	0-10	0-10	0-10	0-10	0-10	0-10	0-10	0-10	0-10
6th	0-10	0-10	0-10	0-10	0-10	0-10	0-10	0-10	0-10	0-10	0-10
7th	0-10	0-10	0-10	0-10	0-10	0-10	0-10	0-10	0-10	0-10	0-10
8th	0-10	0-10	0-10	0-10	0-10	0-10	0-10	0-10	0-10	0-10	0-10
9th	0-10	0-10	0-10	0-10	0-10	0-10	0-10	0-10	0-10	0-10	0-10
10th	0-10	0-10	0-10	0-10	0-10	0-10	0-10	0-10	0-10	0-10	0-10
11th	0-10	0-10	0-10	0-10	0-10	0-10	0-10	0-10	0-10	0-10	0-10

* The data reported in this publication are also subject to variation and consequently are not.

19-85-81-0

T255
16

WARNING



Do not remove radiator cap while engine is hot. Hot steam will injure you.

26

CAUTION



Keep hands and clothing away from rotating fan and belts to prevent serious injury.

24

WARNING



Do not remove radiator cap while engine is hot. Hot steam will injure you.

25

SAFETY PRECAUTIONS

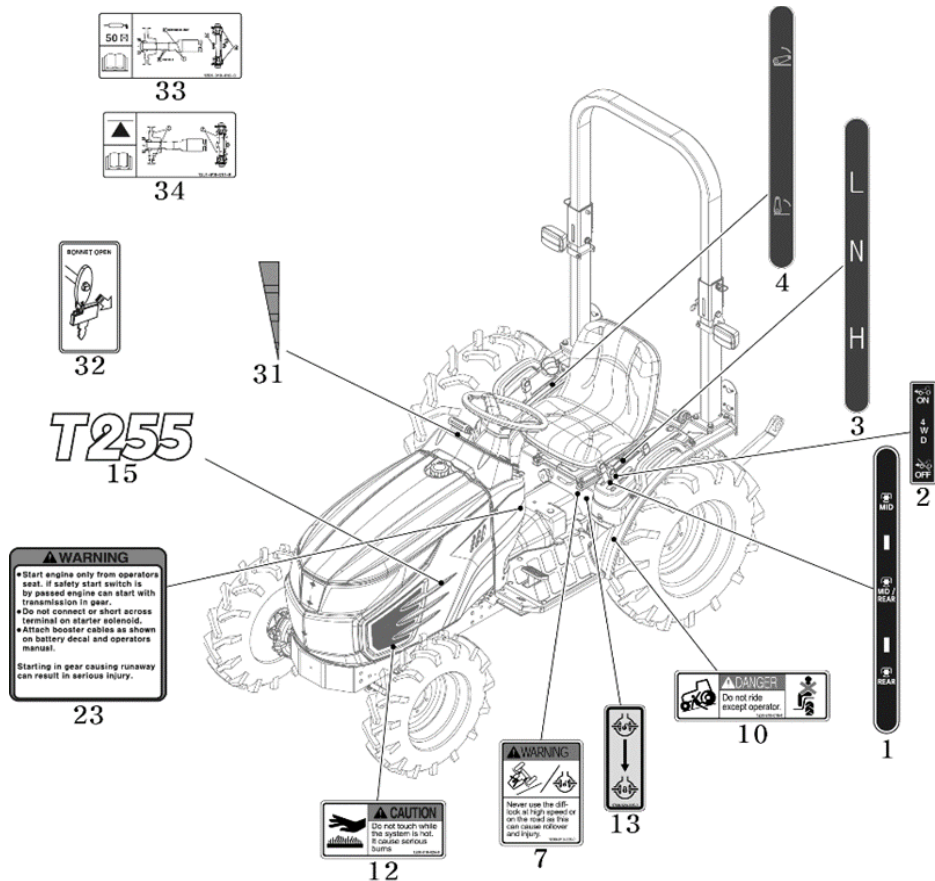

WARNING

- Start engine only from operators seat. If safety start switch is bypassed engine can start with transmission in gear.
- Do not connect or short across terminal on starter solenoid.
- Attach booster cables as shown on battery decal and operators manual.

Starting in gear causing runaway can result in serious injury.

23

CAUTION

Do not touch while the system is hot. Hot metal surfaces can cause serious burns.

12

WARNING

Never use the diff lock at high speed or on the road as this can cause a rollover and injury.

7

13

DANGER

Do not ride except operator.

10

T255

15

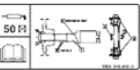

33



34



32



31



2



1

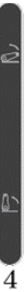

4



3

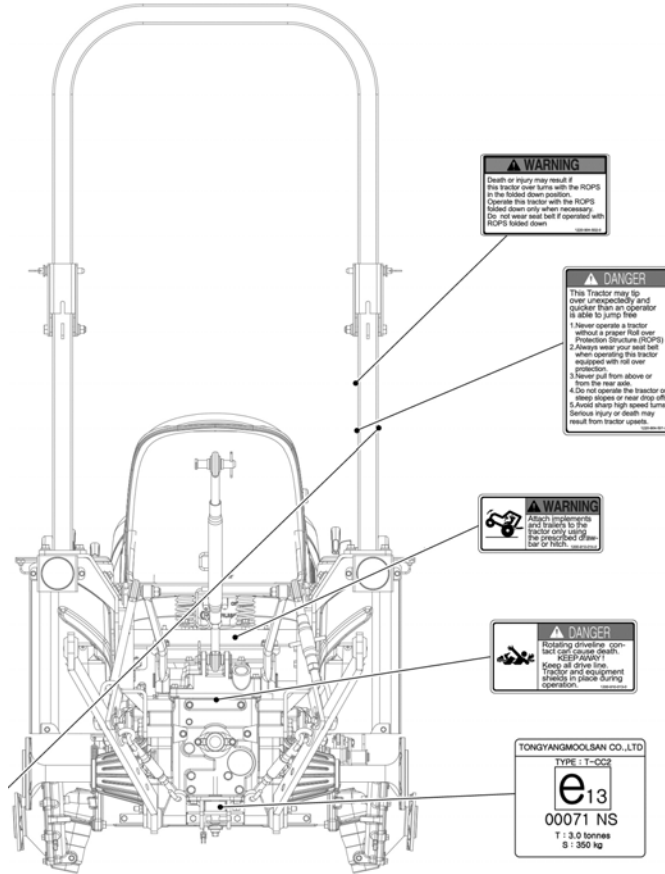



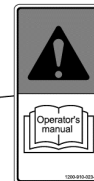
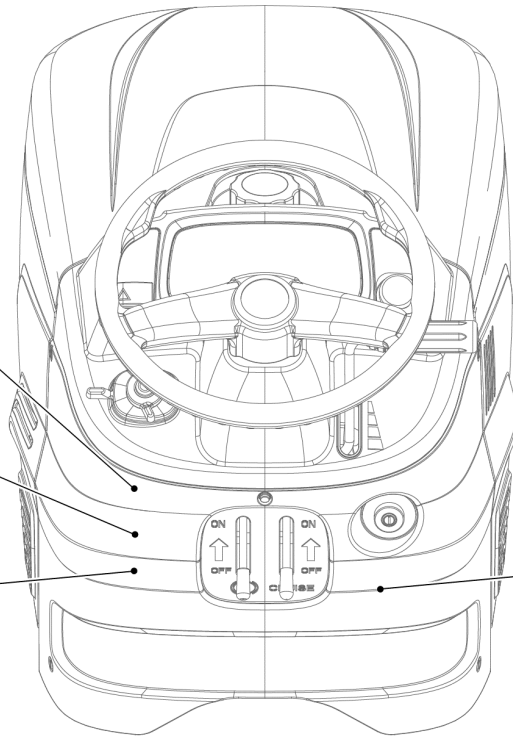
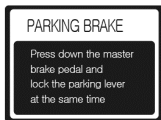
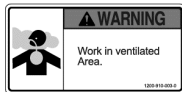



























SAFETY PRECAUTIONS



5. UNIVERSAL SYMBOLS

Some of the universal symbols have been shown below with an indication of their meaning.

DESCRIPTION	SYMBOL	DESCRIPTION	SYMBOL	DESCRIPTION	SYMBOL
ENGINE SPEED (REV/MIN X 100)		PRESSURED, OPEN SLOWLY		CORROSIVE SUBSTANCE	
HOURS, RECORDED		CONTINUOUS VARIABLE		SLOW OR MINIMUM SETTING	
ENGINE COOLANT TEMPERATURE		HAZARD WARNING, CAUTION		FAST OR MAXIMUM SETTING	
FUEL LEVEL		HAZARD WARNING		TRANSMISSION OIL PRESSURE	
ENGINE STOP CONTROL		NEUTRAL		TURN SIGNAL	
LIGHTS		FAN		TRANSMISSION OIL TEMPERATURE	
HORN		POWER TAKE OFF ENGAGED		PARKING BRAKE	
ENGINE OIL PRESSURE		POWER TAKE OFF DISENGAGED		WORKING LAMP	
AIR FILTER CONTAMINATED		RAISE LIFT ARM		DIFFERENTIAL LOCK	
BATTERY CHARGE		LOWER LIFT ARM		REFER TO OPERATOR'S MANUAL	

B



C. TRACTOR INSTRUMENTS

1. SWITCHES C – 2
2. MONITOR PANEL & GAUGES C – 5
3. CONTROL INSTRUMENTS C – 10
4. THREE POINT LINKAGE C – 16



1. SWITCHES

► FIGURE OF DASHBOARD

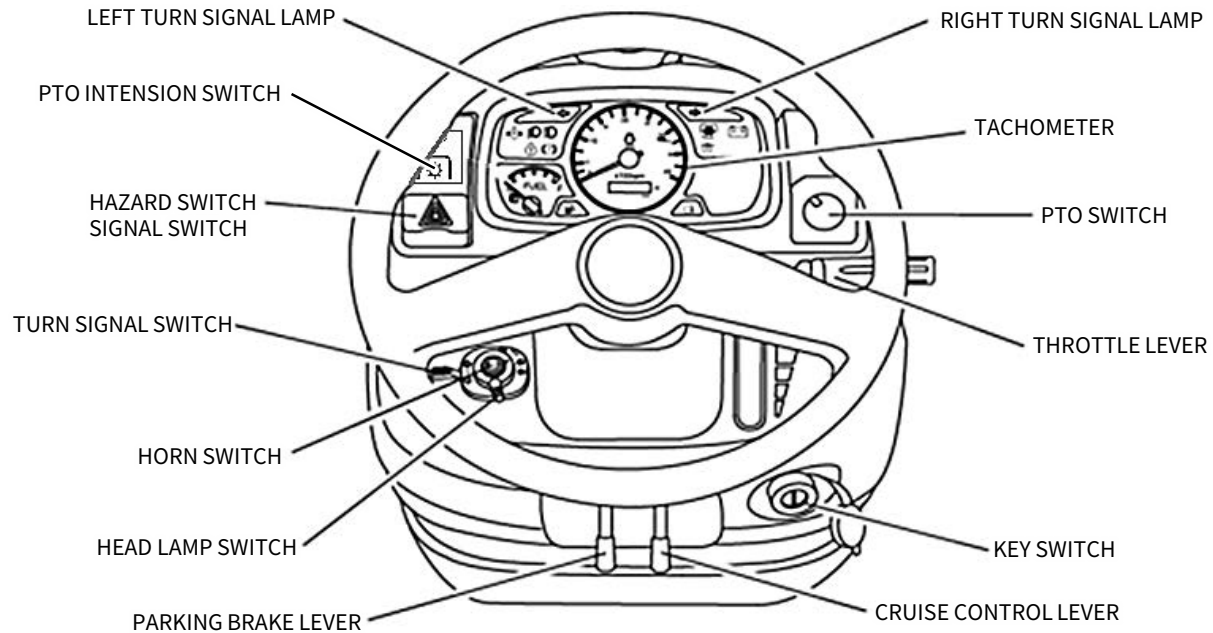

▶ **KEY SWITCH**

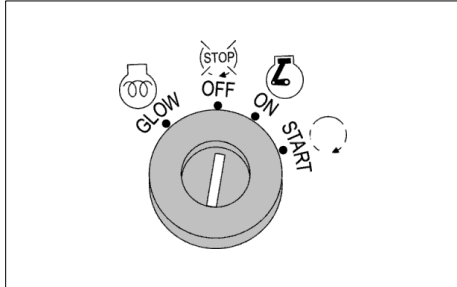

- 『OFF』 : The key can be inserted or removed.
- 『ON』 : The electric circuit is on.
- 『GLOW』 : Glow plugs pre-heat the combustion chamber.
- 『START』 : The starter motor is engaged.
When the key is released it will automatically return to the 『ON』 position.

▶ **COMBINATION SWITCH**

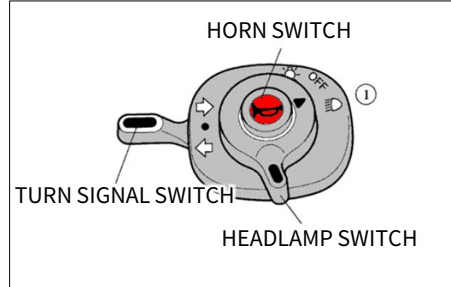

<HEAD LAMP SWITCH>

Head lamp is operated on the main switch.

- OFF position : Head lamp is turned off.
- Low beam position(①) : Head lamp is turned on.

<TURN SIGNAL SWITCH>

Pull the turn signal lever down to signal a left turn.

Push the turn signal lever up to signal a right turn.

<HORN SWITCH>

Push the red button to sound a horn.

▶ **HAZARD WARNING SIGNAL SWITCH**



Push the hazard warning signal switch once to operate the hazard warning signals. (Left and right turn indicators flash at same time).

Push the hazard warning signal switch again to switch off the hazard warning signals.

C

► **PTO SWITCH**

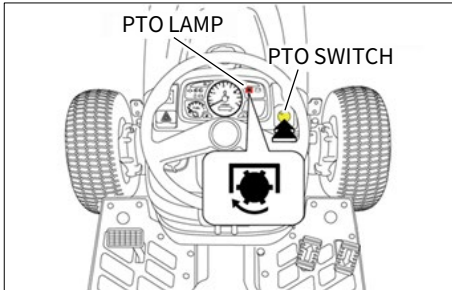

PTO ON/OFF switch is situated on the right hand side on the instrument panel and can be identified easily with its built in green colored indicator.

When the switch is pushed down to start the PTO indicator glows to indicate that the switch and the PTO are in ON position.

If the switch is pushed down again the indicator goes off signaling that the PTO is OFF.

The PTO shaft will not rotate if switch is in OFF position.

► **PTO INTENTION SWITCH**

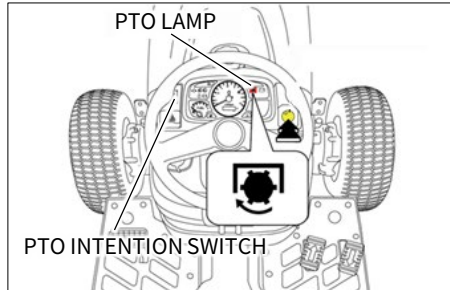

PTO intention switch can control the rotation of PTO shaft on condition of driver's position.

- ON - PTO shaft keep rotating whether driver left the seat or not.
- OFF - PTO shaft stops when driver left the seat.

2. MONITOR PANEL & GAUGES

► MONITOR PANEL

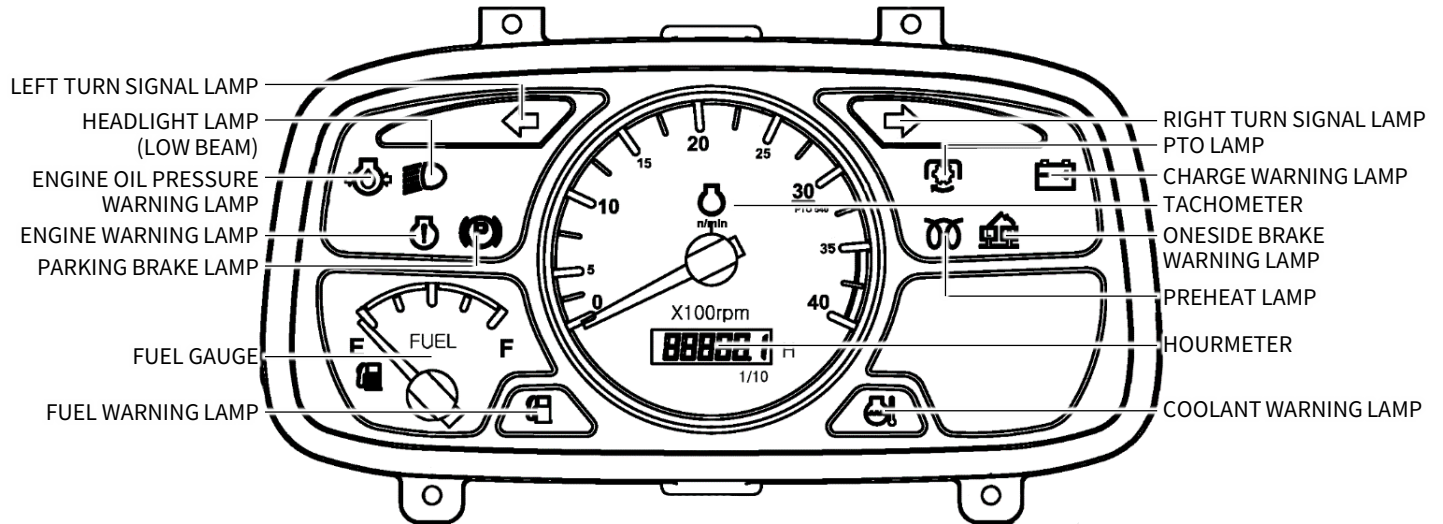

C

▶ **TACHOMETER**

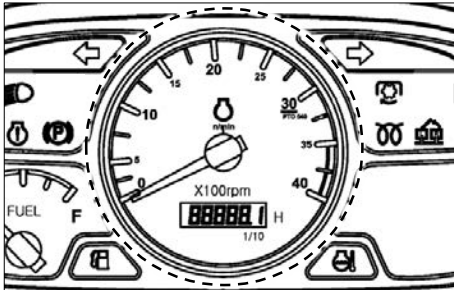

This meter shows the revolutions of the engine and the PTO shafts as well as the travel speed in top gear.

▶ **HOURLMETER**

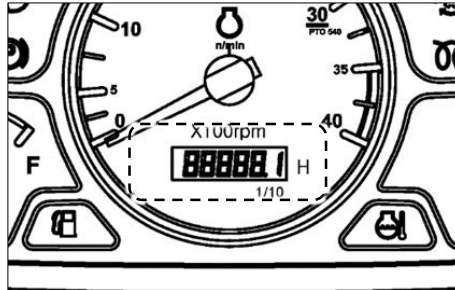

The hour meter consists of digits with the last digit indicating $\frac{1}{10}$ of an hour. It shows hours the tractor has been used. The lamp at bottom of hour meter should twinkle during operation.

▶ **FUEL GAUGE & FUEL WARNING LAMP**

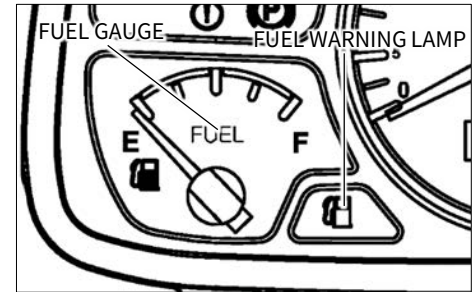

<FUEL GAUGE>

This Shows the amount of fuel in the fuel tank when the key switch is ON.

<FUEL EMPTY WARNING LAMP>

This lamp shows warning that the fuel in fuel tank goes empty. If this lamp comes on, Fill the tank with fuel.

▶ TURN SIGNAL LAMPS

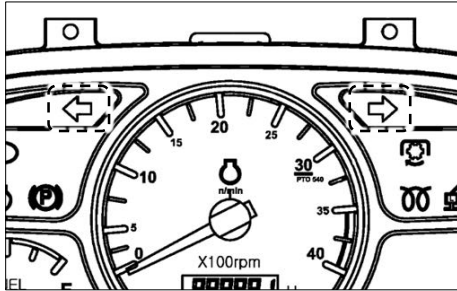

This lamp is used to indicate the intended turning direction of the driver. When pulling down the turn signal switch, the left turn signal lamp blinks. When pushing up the turn signal switch, the right turn signal lamp blinks.

These lamps are operated when pressing the hazard warning lamp switch as well.

▶ HEADLIGHT LAMP

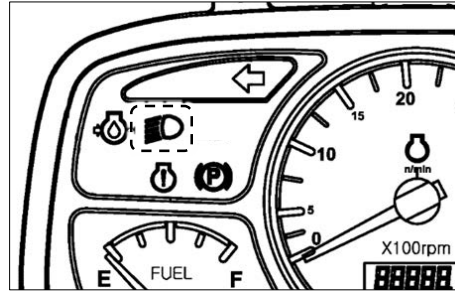

This comes on when the low beam is turned on.

▶ OIL PRESSURE WARNING LAMP

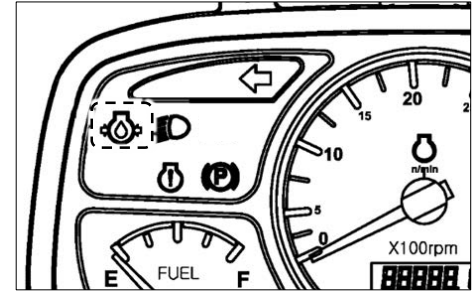

This lamp will go out as soon as the engine starts if the oil pressure is correct. If it comes on while the engine is running, stop the engine and get expert advice.

C

▶ **PARKING BRAKE LAMP**

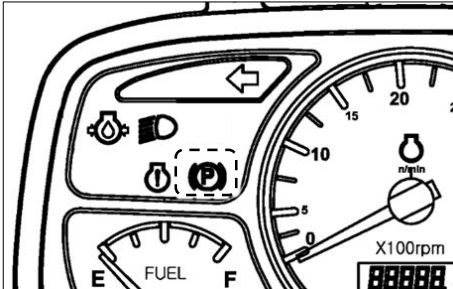

This comes on when parking brake is engaged.

▶ **ENGINE WARNING LAMP**

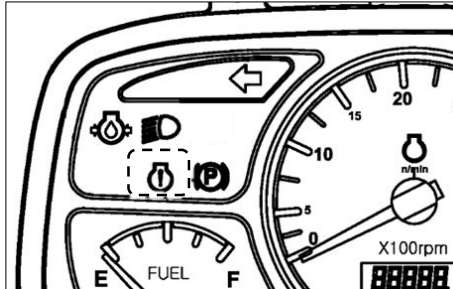

This lamp comes on when the engine is malfunctioning.

▶ **PTO LAMP**

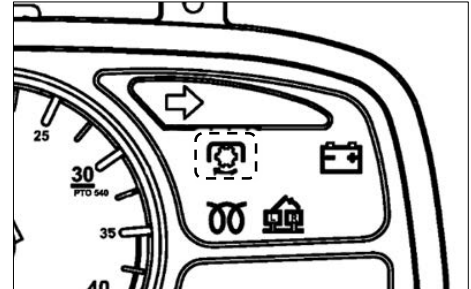

This lamp will turn on when PTO is engaged.

 **CAUTION**

- When Engine warning lamp comes on, ensure that you operator the tractor only after the engine RPM reaches at the normal speed. If this instruction is not kept, it may cause a performance degradation.

1. If the monitor glows: The PTO is ON.
2. If the monitor is off: The PTO is OFF.

▶ CHARGE LAMP

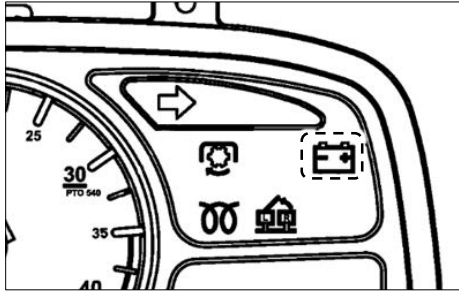

This lamp will go off as soon as the engine starts to run to indicate that the alternator is charging normally.

(Please note, as broken fan belt can cause the light to come on, please stop the engine as overheating can occur if not rectified immediately).

▶ GLOW SIGNAL LAMP

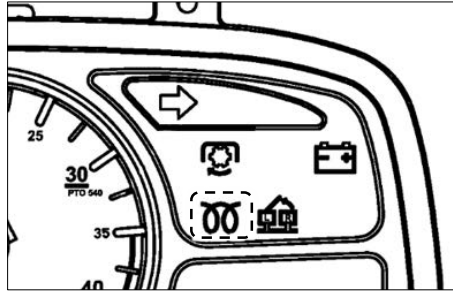

This lamp indicates pre-heating.

▶ COOLANT TEMPERATURE WARNING LAMP

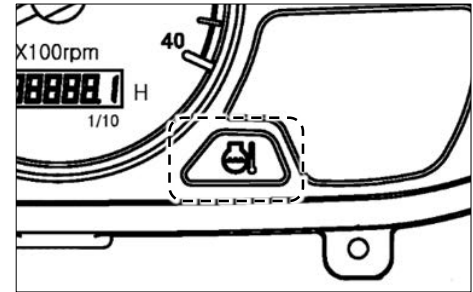

This comes on when engine is overheated.

C



3. CONTROL INSTRUMENTS

▶ TRACTOR CONTROLS

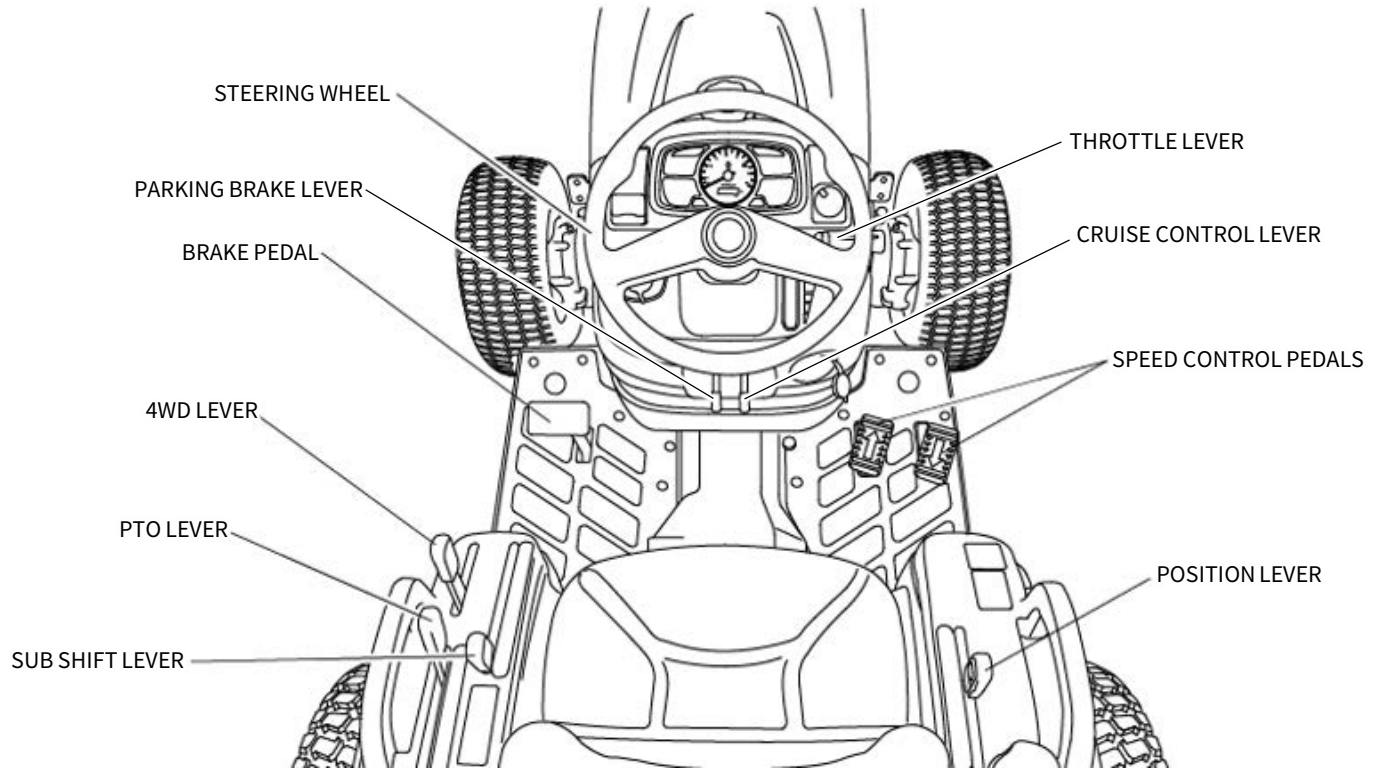

► **BRAKE PEDAL**

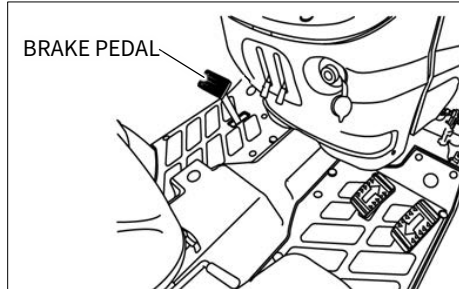

Brake pedal is used for slowing down the speed or stopping the tractor.

► **PARKING BRAKE LEVER**

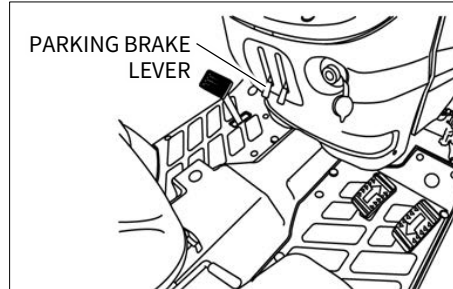

Push the brake pedal down while pulling the parking brake lever up to engage.
Press the brake pedal to release parking brake.

 **IMPORTANT**

- Traveling with the parking brake on will damage the brakes.

► **SPEED CONTROL PEDALS**

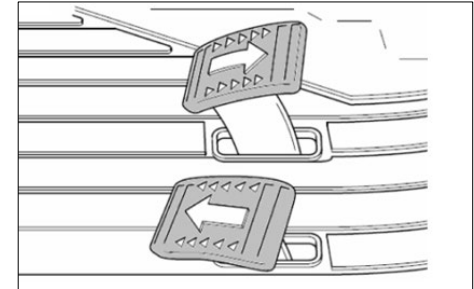

The speed control pedal is located in the RHS of the operator floor. Depress the forward speed control pedal to move forward. Depress the reverse speed control pedal to move backward.

The speed control pedal will return to neutral position and the tractor will stop when the speed control pedal is released.

▶ THROTTLE LEVER

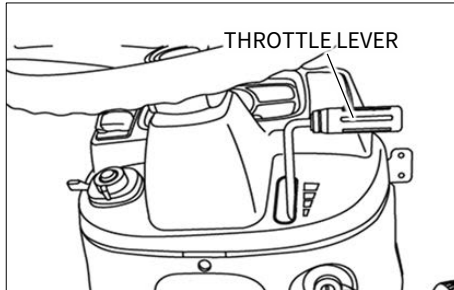

The hand throttle lever is used to change engine speed.

Pulling the throttle lever toward the operator decreases engine speed. Pushing it away from the operator increases engine speed.

▶ CRUISE CONTROL LEVER

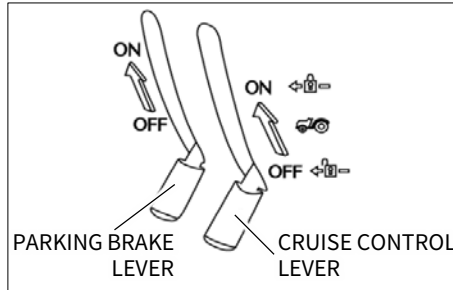

1. Engaging Cruise Control
DO NOT engage cruise control when reversing.
 - Engage the cruise control as follows:
 - Depress the forward speed control pedal until the required speed is achieved.
 - push up the cruise control lever to engage cruise control.
 - Release the forward speed control pedal.
2. Disengaging Cruise Control
To disengage the cruise control you can either depress forward speed control pedal or the master brake pedal.

▶ SUB SHIFT LEVER

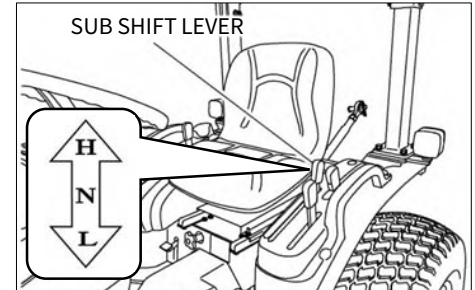

The sub shift lever provides two speed of L and H.

The tractor should be stopped before changing speed ranges.

Choose L, H speed range on sub shift lever to match work application.

IMPORTANT

- Avoid damage!
Select the proper speed range and gear for the mob.
- The machine maybe operated in any gear with engine speeds at 1,350 ~ 3,000 rpm.
Within these limits, the engine can be placed under varying load operations.
- Never overload the engine by lugging machine at low idle speeds.
- Raise the engine speed to match expected loads.
If a slight increase in engine rpm occurs simultaneously while moving the hand throttle lever forward, the engine is not overloaded.

▶ **4WD LEVER**

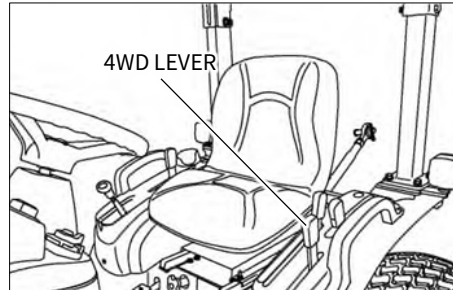

4WD lever is located below the LHS of the operator.
In the ON position the front wheels are engaged and in the OFF position they are disengaged.
Engage or disengage the front wheel drive with the front wheels in the straight position and at low speed.

The use of front wheel drive improves traction performance.

IMPORTANT

- Do not use front wheel drive at high speed or on the road as premature wear of components will result.

▶ **PTO LEVER**

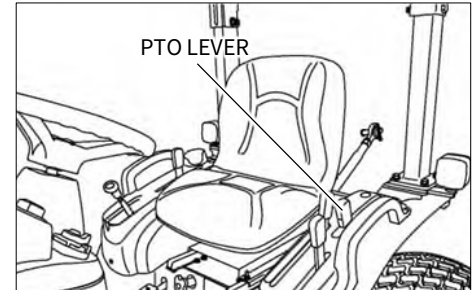

Rear PTO, mid PTO or both PTO can be selected by PTO lever.

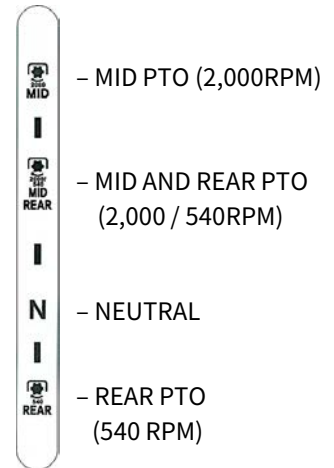



CAUTION

- To avoid damage of transmission and implement, do not engage PTO with the engine running at high speed.
- Do not operate any implement at a high speed than is specified for it.
- When making adjustments to the implement stop the engine to avoid serious injury.
- When leaving the tractor stop the engine, and remove the key.
- Set the parking brake.

► POSITION LEVER

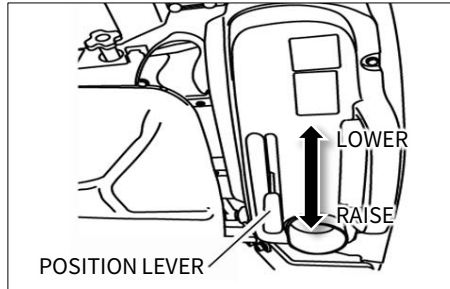

The position lever is used to raise or lower the implement mounted to the three point hitch.

Push : Lower the hitch.

Pull : Raise the hitch.

Adjustable stops are provided for use whenever it is desirable to return the hitch control lever to the same operating position.

CAUTION

- After finishing the work, always lower the implement to the ground and switch off the engine. Set the parking brake to avoid injuries and accidents.
- When working with the 3-point linkage, keep well clear of the operating radius of the lift arms and any attached implement. This is to avoid the risk of injury in the case of incorrect maneuvers.

► DIFFERENTIAL LOCK PEDAL

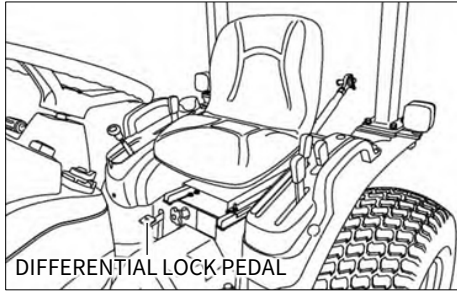

The differential lock pedal is located below the LHS of the seat. In case of wheel slippage use the diff-lock by pushing down on the diff lock pedal.

To release it, remove the foot from the pedal.

► LOWERING SPEED CONTROL KNOB FOR THE 3POINT HITCH

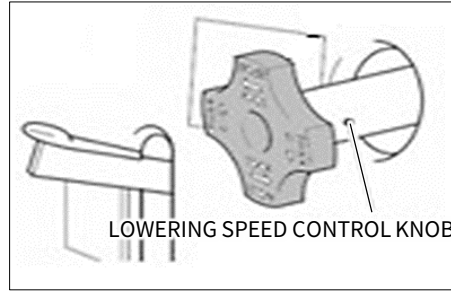

This knob controls the downward speed of the three point linkage of hydraulic and is located below the seat.

To slow the downward speed, turn the knob clockwise.

To increase the downward speed, turn the knob counter clock-wise.

To lock, turn the knob clockwise; Do not over tighten the knob.

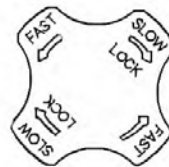

 CAUTION

- Always set the knob to lock when
 1. Traveling on the road.
 2. Replacing tires or blades on an implement.
 3. Making adjustments to an implement. Sudden dropping of an implement due to hydraulic problems can cause serious injury or death.

C

3. THREE POINT LINKAGE

▶ **FIGURE OF THREE POINT LINKAGE**

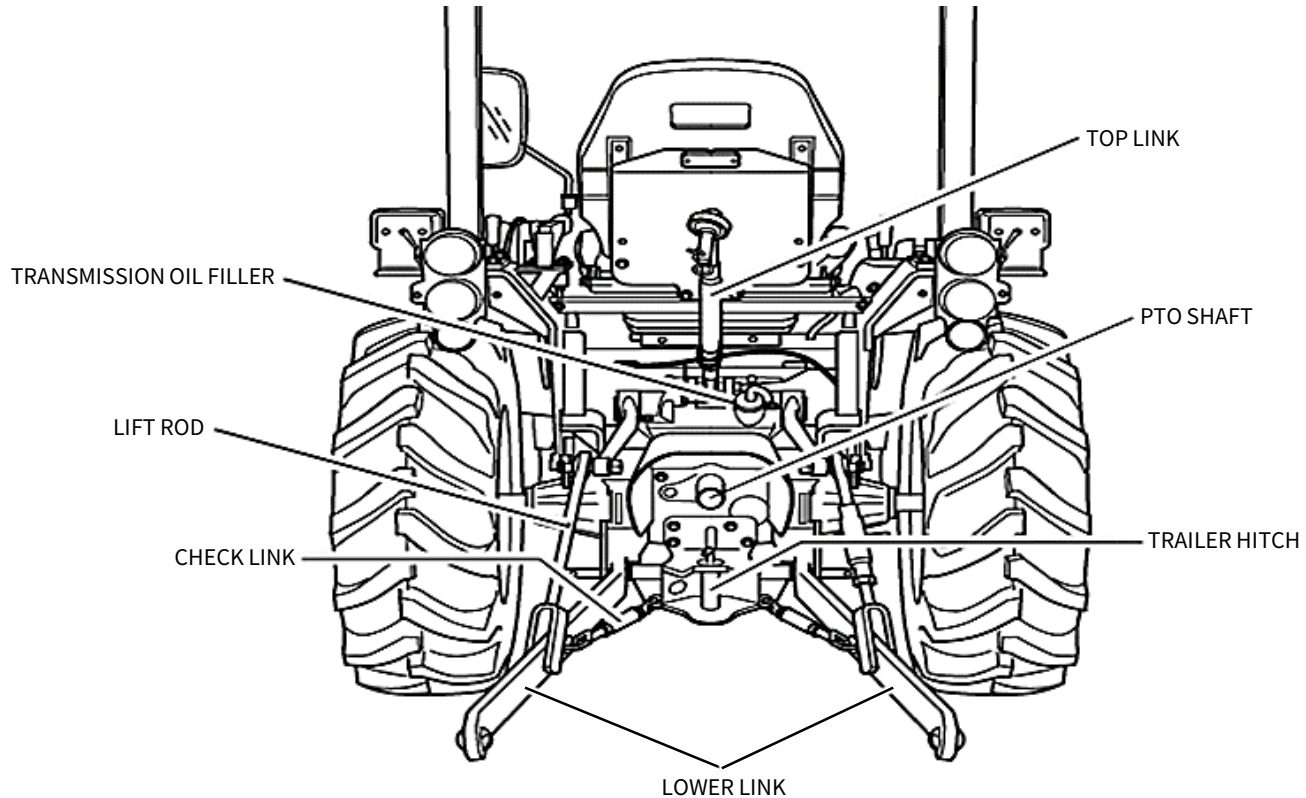

▶ **ADJUSTMENT OF TOP LINK**

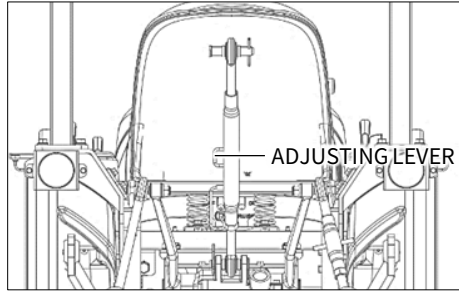

The angle of an implement can be adjusted by extending or retracting the top link.

After adjustment, fix the adjusting lever with its mounting net.

▶ **ADJUSTMENT OF LIFT ROD**

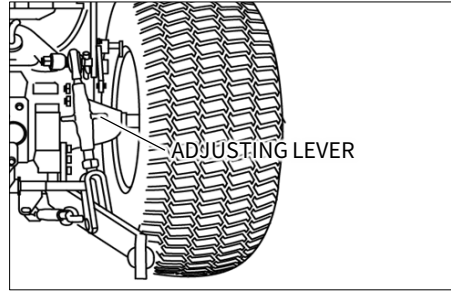

Adjust the length of the lift rod by screwing the adjusting handle (turnbuckle) in or adjust the length of the lift rod as necessary to set the implement in its working position parallel to the ground.

▶ **ADJUSTMENT OF CHECK LINK**

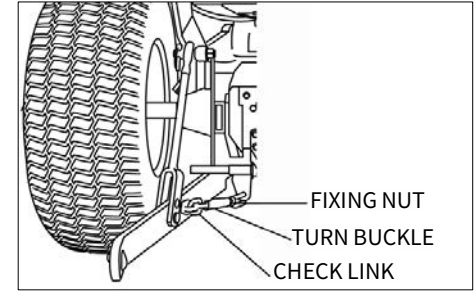

To adjust the check chain, turn the turnbuckle to lengthen or shorten the chain.

Tighten the lock nut when the correct adjustment is achieved.

C

▶ ADJUSTMENT OF YOKE ROD ON LOWER LINK

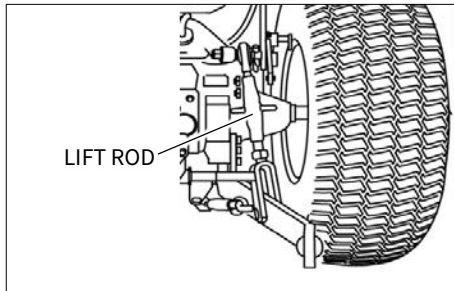

For different applications change the position of the yoke rod on the lower link holes as shown and insert the pin in the direction of the arrow

▶ PTO SHAFT CAP

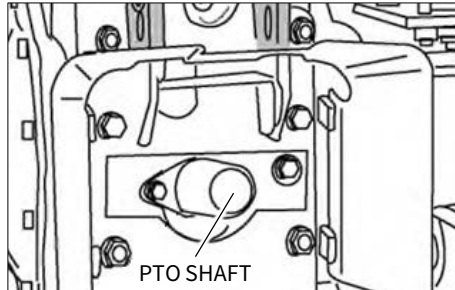

When the PTO shaft is not in use, apply grease and place its cap to it.

⚠ CAUTION

- It is dangerous to use implements at a high speed if it is designed to be operated at a low speed.
- Before using implements, make sure to read its owner's manual.

⚠ DANGER

- Stay out of PTO shaft while it is rotating.
- If caught by PTO shaft, a severe injury or even death can occur.
- Do not remove PTO safety cover.

▶ TRAILER HITCH

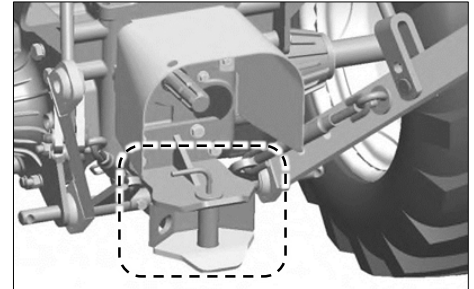

Install only an implement applicable to this tractor.

⚠ WARNING

- Make sure to use the trailer hitch for towing to avoid rollover. Never tow anything by connecting a rope to the top link bracket, axle or safety frame.
- When using a rotavator that draws power through the universal joint from the PTO shaft, remove the trailer hitch from the tractor. Otherwise, the universal joint hits and damages the trailer hitch, leading to an accident.

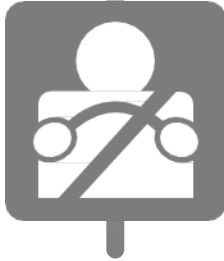

D. OPERATION

1. START & STOP OF ENGINE D – 2
2. OPERATING TRACTOR D – 4
3. OPERATION OF PTO D – 7
4. IMPLEMENTS D – 9
5. TOWING THE TRACTOR D – 10
6. CHECKS DURING DRIVING D – 12
7. WORK PROCEDURES D – 14
8. OPERATION TIPS D – 18

1. START & STOP OF ENGINE

▶ HOW TO START ENGINE

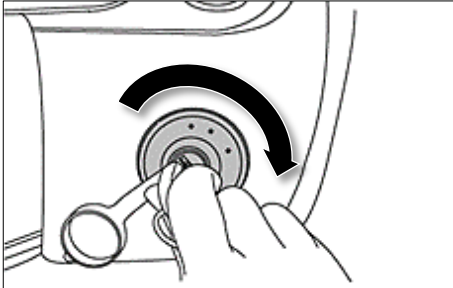

1. Make sure that there is no obstacle around the tractor.
2. Seat on driver's seat and confirm that parking brake is applied.
3. Check that each shift lever and PTO switch are in the neutral position.
4. Push down clutch pedal to activate safety-starting switch.
5. Insert the key into key switch and turn it to 「ON」 position. Check that warning lights are working and come off.
6. Turn key switch to the 「START」 position. When engine is started, release the switch.
7. Ensure that all warning lamps go off.

IMPORTANT

- Never turn the key to 「start」 position while engine is running as this can cause serious damage to starter and engine flywheel.
- Avoiding running the start motor over 10 second. It consumes lots of current.
- If engine cannot be started within 10 second, wait for 30 second and try it again.
- Especially in cold weather, always allow the tractor to idle for a while to warm up and build up for a while to warm up and build up sufficient oil pressure to ensure normal operating temperature for longer engine life.

WARNING

- Never start engine by connecting start motor terminal or safety switch directly. The tractor may move suddenly and cause an accident.

▶ PRINCIPLE OF AUTO PREHEATING SYSTEM

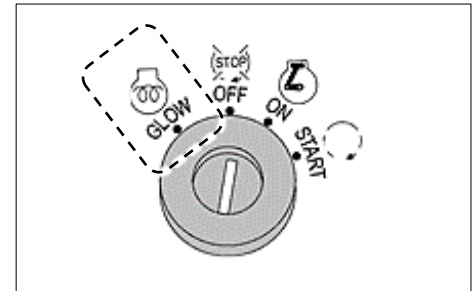

When key switch is in 「ON」 position or glow position, engine is automatically preheated as necessary. Glow lamp is on as well.

As soon as preheating operation is completed, the lamp also goes off.

▶ **STOPPING ENGINE**

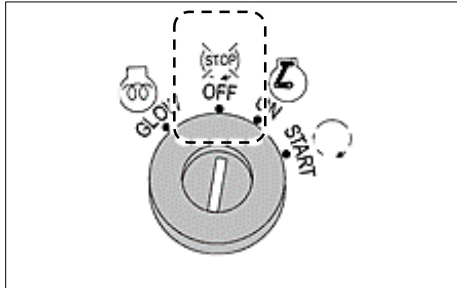

1. Idle engine before stopping it.
2. Turn the key switch to 「OFF」 position.
3. Remove the key from the switch.

▶ **ENGINE IDLING**

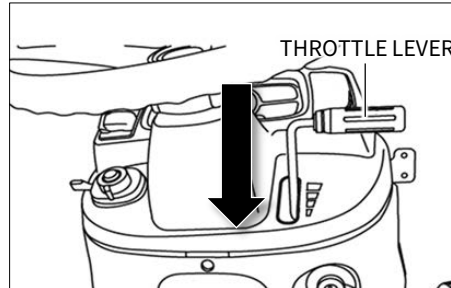

After starting engine, idle engine for 5 ~ 10 minute so that oil is delivered to each part of engine.

▶ **IDLING IN COLD WEATHER**

Hydraulic oil in this vehicle is also used as transmission fluid.

If the temperature drops in winter so oil gets cold, its viscosity rises and the hydraulic pump cannot suck oil in, causing malfunction.

Make sure to idle the engine in winter according to the following instructions.

TEMPERATURE	TIME
32°F or higher (0°C or higher)	more than 10 min.
32°F ~ 14°F (- 0°C ~ - 10°C)	10 ~ 20 min.
14°F ~ - 4°F (- 10°C ~ -20°C)	20 ~ 30 min.
- 4°F or less (- 20°C or less)	more than 30 min.

 **WARNING**

- Proper ventilation is needed when engine idling is performed indoors.

D

2. OPERATING TRACTOR

▶ STARTING OFF

1. Lift an implement.
2. Place main and sub shift lever into the desired position while depressing clutch pedal.
3. Depress brake pedal to release parking brake.
4. Use throttle lever or pedal to increase engine speed.
5. Depress proper speed control pedal to move desired direction.

▶ SHIFTING AND DRIVING

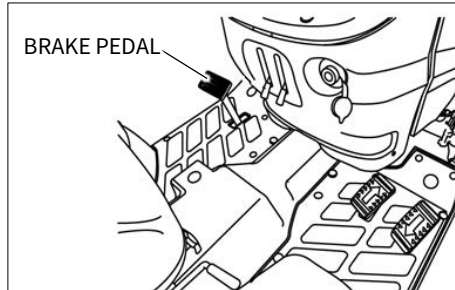

To shift during driving, depress the brake pedal to stop the vehicle in advance.

WARNING

- The driving speed in the reverse direction is almost the same to the speed in the forward direction. Make sure to check the surroundings carefully when driving backward.
- Especially, never drive backwards with the sub shift lever in the position high speed. The driving speed becomes faster and it can cause an accident.
- Connect the left and right brake pedals when it is about to drive when two brake pedals are installed.

▶ TURNING IN FIELD

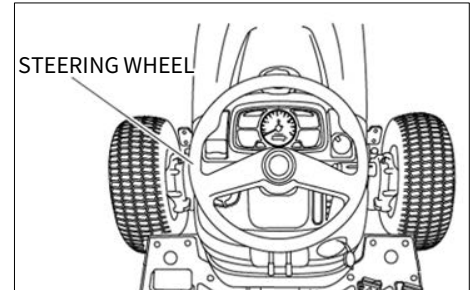

When two brake pedals are installed.

1. To turn in a field, release hook for left and right brake pedals.
2. Turn steering wheel and depress brake pedal for desired direction.
3. While turning, keep engine speed low and turn slowly.

When single brake pedal is installed.

Turn steering wheel to desired direction.

WARNING

- Avoid turning at a high speed. The tractor can fall on its side.
- When the tractor is installed with an implement, its overall length becomes large. Be extra care with other people and objects around when turning.

► **PARKING THE TRACTOR**

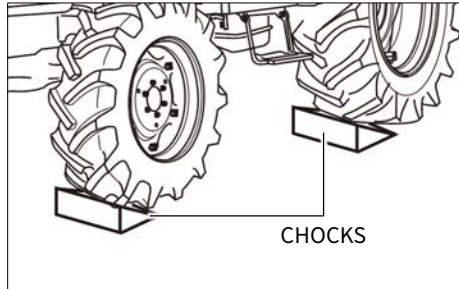

1. Stop tractor completely in level ground.
2. If an implement is attached to vehicle, lower it.
3. Set levers in neutral position.
4. Apply parking brake.
5. Remove key from key switch.

 **WARNING**

- After parking, make sure to apply the parking brake.
- Avoid parking on a slope if possible. If it is absolutely necessary to park on a slope, chock the rear wheels.

► **START ON STEEP SLOPE**

1. Depress the brake pedals.
2. Place sub shift lever in the low speed position.
3. Set engine at the mid speed with the throttle lever.
4. Depress the throttle pedal or use throttle lever to increase engine revolution.
5. Release the brake pedal at the same time.

► **TIPS FOR DRIVING ON SLOPE**

1. Set sub shift lever in low speed position on a slope to prevent engine from stopping.
2. Keep driving speed low on a downhill road.
3. Do not set sub shift lever in neutral position on a downhill road.

 **IMPORTANT**

- When the needle on the coolant temperature gauge is pointing at 「H」 or coolant lamp comes on, engine is overheated.
If running the engine under this condition continuously, the engine parts can be severely damaged. Make sure to take an appropriate action immediately.

 **WARNING**

- On a downhill road, use the engine brake. Otherwise, it can cause an accident.



▶ CAUTIONS FOR DRIVING INTO OR OUT OF FIELD

1. Check that left and right brake pedals are connected.
2. It is dangerous to drive into/out of a field if the field is deep from its bank. Use ramps.
3. Move in the perpendicular direction to the bank.
4. When driving out of the field, lower the implement so that the front wheels cannot be lifted.
5. It is recommended to drive into a field backward to utilize full power.

WARNING

- Be careful to keep the tractor's balance when working on a slope. The tractor may become out of balance and roll over.
- It is very dangerous to ride a person as a front weight.

▶ LOADING TO OR UNLOADING FROM TRUCK

1. When loading the tractor onto a truck, drive backward.
2. Be extra careful when using ramps.
3. If the engine stops on ramps, depress the brake pedals immediately and release them slowly to move onto the ground. Then, start the engine again to climb the ramps again.

▶ CAUTIONS FOR DRIVING ON ROAD

1. When changing the direction on a road, use the turn signal lamp to inform other drivers.
2. Use the low beam when there is any vehicle coming on the other side at nighttime.
3. Check that the left and right brake pedals are connected.
4. Keep the work lamps off when driving at night.
5. Follow any applicable laws and keep safe driving.
6. Never let anyone ride the tractor, except yourself as a driver.

WARNING

- If driving on a road with an implement attached, the front side of the tractor tends to be lifted and vehicle may not be steered properly.

3. OPERATION OF PTO

Rear and mid PTO is provided for variable utility.

The engine will not start if PTO switch is ON position.

The engine will shut-off if the operator leaves the seat with parking brake released and PTO engaged.

PTO	PTO speed
REAR	540 RPM
MID	2,000 RPM

WARNING

- To avoid damage of transmission and implement, do not engage PTO with the engine running at high speed.
- Do not operate any implement at a high speed than is specified for it.
- When making adjustments to the implement, stop the engine to avoid serious injury.
- When leaving the tractor stop the engine and remove the key. Apply parking brake.

▶ OPERATING PTO

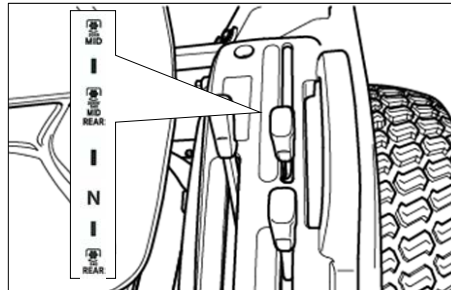
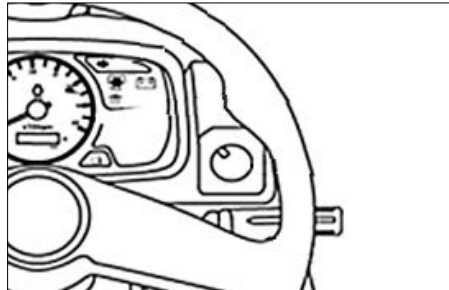

Follow next steps to use PTO.

1. Decrease engine speed to near idle.
2. Change PTO shift lever to desired positions.
3. Turn on the PTO switch.
4. Increase engine speed to desired speed.

▶ PTO LAMP

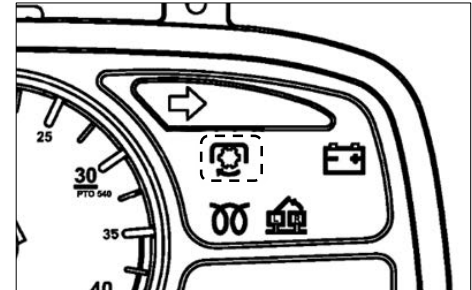

PTO monitor lamp indicates the state of the PTO shaft.

- **If the monitor glows:**
The PTO is rotating.
- **If the monitor is off:**
The PTO is off.
- **If the monitor blinks:**
The PTO is presently stationary but will instantly start rotating of the implements lowered.

► PTO ROTATION TABLE

N/A : not applicable

PTO SWITCH	PTO SHIFT LEVER	POSITION OF IMPLEMENT	PTO LAMP	PTO SHAFT ROTATING
OFF	N/A		OFF	OFF
N/A	N/A		OFF	OFF
N/A	OFF	N/A	OFF	OFF
ON	ON	RAISED	BLINK	OFF
ON	ON	LOWERED	ON	ON
ON	ON	N/A	ON	ON

- From the table above we learn about the safety features of the PTO. When the monitor on the dash panel is blinking it indicates to the operator that the PTO is in the on position but temporarily not rotating because the implement is lifted off the ground or both. The PTO will start rotating instantaneously when the implement is lowered to the ground.
- The operator must use this blinking signal to clear the area around the tractor off bystanders/onlookers as the rotating blades of certain implements can accidentally cause injuries to the persons standing near the tractor.
- The stopping of the PTO when the implement is lifted off the ground with the position control prevents the damage to the implement or the PTO shaft.

WARNING

- When the PTO mode switch is in manual position the PTO does not stop rotating. If working on hard soils, pavements with a rotary implement the PTO ON/OFF switch must be put to the OFF position to stop the PTO from rotating. If this is not done, the rotating blades of the implement will push on the hard ground below and in turn push the tractor toward causing accident which can lead to serious injuries or death.
- Extra precaution must be taken to clear the area of bystanders/onlookers when using PTO driven implements. The rotating blades of the implements can cause serious injuries on contact. The warning that is indicated by the blinking PTO monitor is to make the operator aware that the PTO is in on position and will instantly start rotating if the implement is lowered or both.
- In no case the specified rotating speeds indicated by the implement manufacturer be crossed as the same can lead to serious damage to the tractor/equipment and can lead to serious injuries to persons around.

4. IMPLEMENTS

► CONNECTION TO IMPLEMENTS

1. Make sure to stop the engine before connecting the implements.
2. Move the double acting valve lever forward and backward for 4 to 5 times to release pressure in the hydraulic line of tractor. Otherwise, it is hard to connect the couplers, and hydraulic fluid can be sprayed from the line and get in to your eyes while connecting them.
3. Remove any foreign material around male and female couplers. If foreign material enters the hydraulic components, it can lead to malfunction of the system.
4. Open dust-proof cover of female coupler of the tractor and insert the male coupler of the implement. A clicking sound is heard when the couplers are engaged.
5. Pull the hydraulic hose of the implement to check that the couplers are properly connected.

※ **Hydraulic control valves may not exist depending on tractor model.**

► DISCONNECTION FROM IMPLEMENTS

1. Make sure to stop the engine before disconnecting it.
2. Release any residual pressure in the hydraulic hoses of the implement and tractor by operating the double acting valve lever 4 to 5 times.
3. Remove any foreign material around the couplers.
4. Keep the implement balanced by removing any load applied (lowering it onto the ground, for example).

If disconnecting the hose while outer load is applied to the implement, it is hard to connect the implement in the future.

5. Remove the male coupler by pushing the female coupler boss of the tractor backward.
6. Close the dust-proof cover of the female coupler of the tractor. Wrap the male coupler of the implement with a plastic bag to prevent contamination.

► MOUNTING IMPLEMENTS

If the PTO is used, remove the safety cover off the PTO shaft. Adjust the yoke rod on the lower links to suit the implement in use. Attach the left lower link, then attach the right lower link using the adjusting handle on the leveling box if required. Attach the top link. Attach PTO shaft to the tractor if used, making sure that it is locked in place. Adjust the check chains to suit the implement and tighten the locknuts.

WARNING

- Never connect or disconnect the implement hydraulic hose while the pressure in it is not released or the engine is running. It's hard to connect and disconnect the hose and hydraulic fluid can be sprayed from the hose, and get into your eyes or skin.
- stop engine and wear protective glasses and gloves before work.

6. TOWING THE TRACTOR

▶ TOWING THE TRACTOR

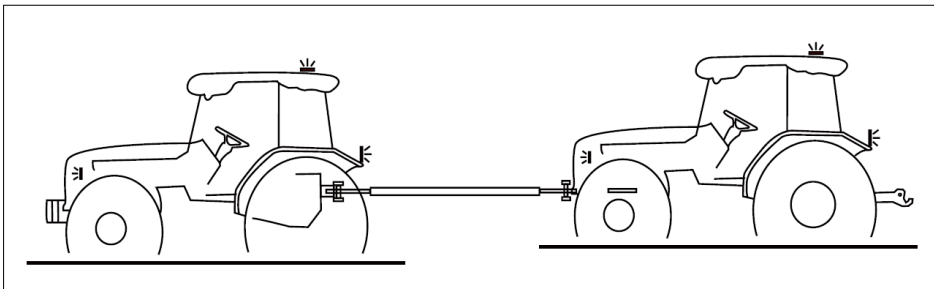

The tractor can be towed only for short distances, such as, for example, from inside to outside a building.

A broken down tractor should be towed for the minimum indispensable distance to remove it from potentially dangerous conditions.

Observe all legal provisions as envisaged in the highway code relative to national legislation regarding towing manoeuvres.

DANGER

- NEVER permit other persons to access the tractor operator position during towing.

WARNING

- We recommend transporting the tractor on a low loader in the case of longer transport distances. Comply with the maximum width and height regulations for road transport. Check that the loader is suitable for the weight of the tractor to be transported.

CAUTION

- An operator must always be at the tractor's controls when the tractor is being towed.

▶ TOWING WITH ENGINE RUNNING

Towing with the engine running can be performed if forced gearbox lubrication is ensured:

- Engine speed between 1,200 ~ 1,300 rpm.
- Maximum towing speed 8km/h
- Maximum towing distance 1km

For towing the tractor use only a standard bar applied to the front towing hitch approved by the manufacturer. Make sure to use the correct pin for the towing hitch and that it is secured with its locking pin.

Clean all lights required for road use, front and rear, and make sure they are in working order.

Before starting towing check the following conditions:

- Unhitch any implement from the tractor;
- Lock the two brake pedals together with the connecting latch;
- Disengage the power take-off and differential locks;

- Set the shuttle control lever and gear lever to neutral;
- Move the sub shift lever to the high speed position;
- Move the creeper lever to neutral;
- Display the SMV (Slow Moving Vehicle) sign and turn on the rotating beacon and hazard lights

During road transfers observe the following instructions:

- Wait until traffic thins before joining the road.
Exert caution in the proximity of unregulated intersections.
Slow down until you have a clear view in both directions.
- Keep in your lane and drive as close as possible to the curb.
- If a tailback builds up behind you pull into a lay-by as soon as possible to allow the traffic to pass
- When stopping the tractor (in any circumstances) apply the parking brake.

Travel speed must always be such as to allow complete control and stability of the tractor in all conditions.

 **DANGER**

- Never attempt to tow the tractor with ropes (including steel ropes) because rope breakage can cause serious injury.

 **WARNING**

- Switch on the hazard warning lights and revolving warning lights.
Affix suitable notices indicating that the tractor is being towed.
Observe and follow the relevant national regulations.
Observe local safety regulations.

► TOWING WITH ENGINE OFF

With engine stopped and with forced gearbox lubrication system inoperative the tractor should not be towed except when safety is at risk.

 **IMPORTANT**

- With engine stopped and with forced gearbox lubrication system inoperative the tractor can be transferred to a service center only when loaded onto a transporter.

D



7. CHECKS DURING DRIVING

▶ CHECK DURING DRIVING

Constantly monitor the warning lamps on the monitor panel and if any comes on, stop the tractor to determine the cause.

▶ OIL PRESSURE

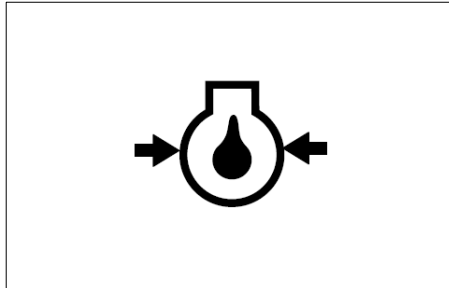

If the oil pressure lamp comes on check the oil level first of all.

If the oil level is OK, ask a qualified dealer to check the reason for the lamp coming on.

▶ BATTERY CHARGING

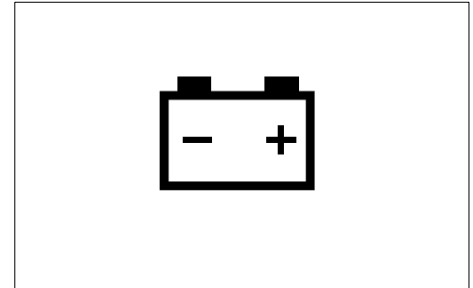

If the alternator warning lamp comes on check all connections and ensure that the fan belt is not broken.

If all connections and the fan belt are intact consult your dealer to determine the cause of the problem.

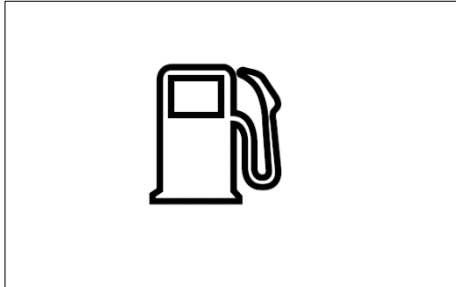
▶ FUEL GAUGE

To avoid excessive condensation in the fuel tank refill at the end of each day's work and ensure during the day that it does not drop to a low level where the fuel system will require bleeding to expel air in the system after refilling the tank.

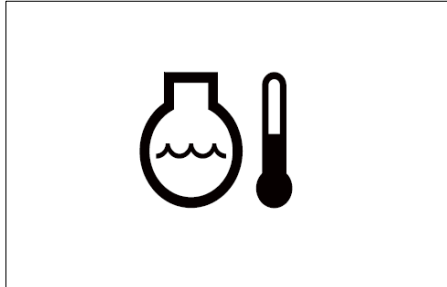
▶ COOLANT TEMPERATURE

If the coolant warning lamp comes on, the engine is over-heated.

Stop the tractor and check followings:

- Radiator coolant
- Radiator fin for clogging
- Fan belt for looseness

If necessary, have your tractor checked by workshop.

 DANGER

- Allow the engine to cool down before opening radiator cap as serious burns may result due to hot steam and boiling water.

D



8. WORK PROCEDURES

► PRECAUTIONS FOR HANDLING IMPLEMENTS

1. When driving the tractor to attach or detach an implement, make sure that there is no one in between or around the tractor and implement.
2. Install and remove the implement only on safe and level ground.
3. When installing a heavy implement, install weight on the front to keep balance.
4. When adjusting an implement, apply the parking brake, stop the engine and set the PTO switch in the OFF position in advance.
5. To tow anything, use the towing hitch only.
6. When working with a front loader, install an implement to the back to keep balance (if necessary).

WARNING

- Read instructions on warning decals on each implement thoroughly before work.
- To avoid an injury due to mishandling of an implement, read the user's manual of the implement thoroughly and work safely and precisely with caution.
- Installation of an improper implement can lead to an injury. Install only implements specified by the manufacturer.

► GENERAL IMPLEMENT

<Safety precautions for rotavator>

Never remove the safety cover of the rotavator.

Do not remove the PTO shaft cover and safety cover on the universal joint.

When adjusting each part, disengage the PTO and stop the engine in advance.

When driving on a road, keep the PTO disengaged.

Also, keep the rotavator lowered on a road as long as it does not hit the ground.

For the universal joint, its inner shaft and outer shaft should be overlapped at least 15 cm.

Check that the universal joint is firmly fixed to the tractor and rotavator shaft.

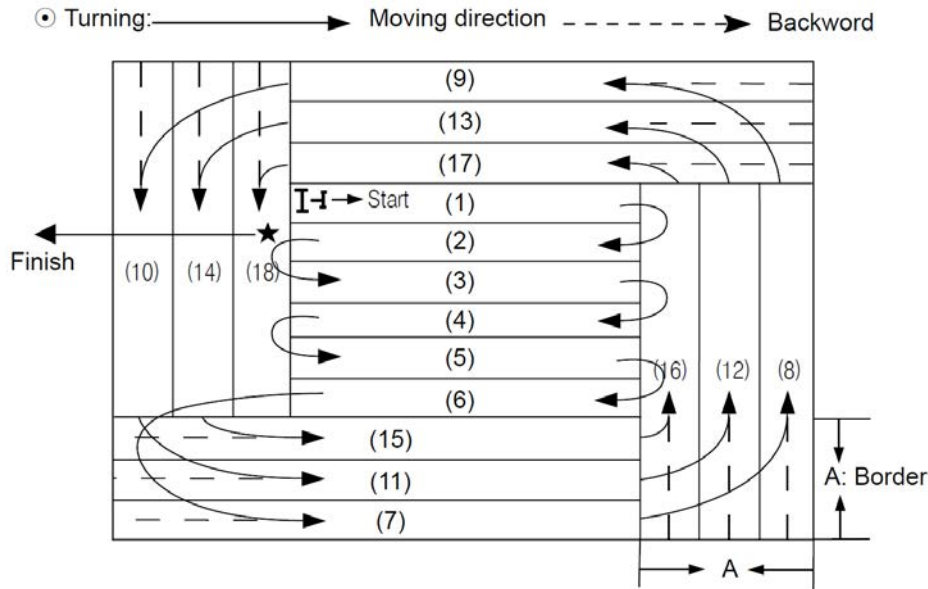

1. Sequential returning plowing pattern

- This pattern can be useful in a well-planned field in a good condition.
- The border shown in the figure is the effective plowing width of the rotavator and should be set a little narrower than three times of one plowing width.
- The starting point is the ending point.
- Plow in a sequential pattern from (1) to (6) and in a circular pattern from (7) to (18).
- When driving forward to plow, have the bank on the right side.
- Be careful not to press already plowed soil with the wheels.

D

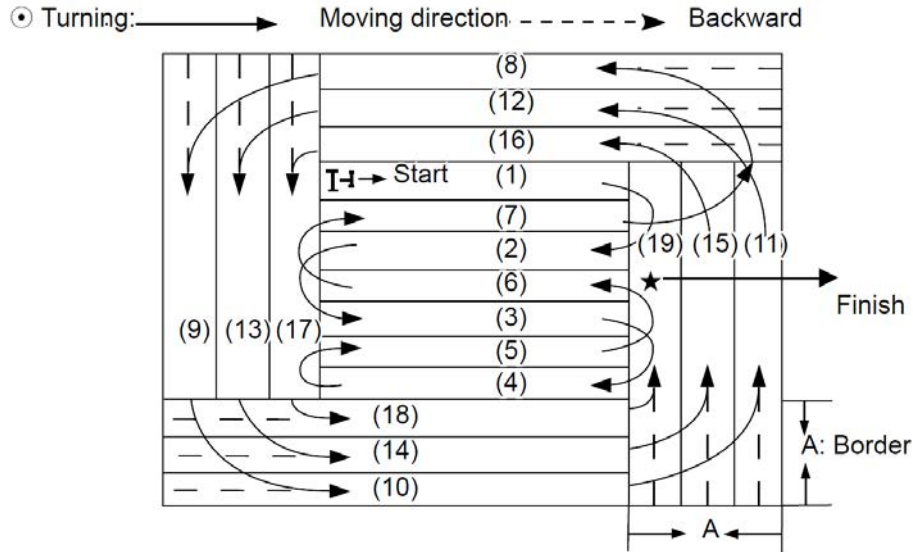

2. Alternating returning plowing pattern

- This pattern is useful for narrow or short fields or poorly planned fields in which are not easy to turn.
- In the figure, the plowing width for (1), (2), (3) and (4) should be overlapped with the one for (5), (6) and (7) for approx. 10 cm.
- For the sections (1) to (7), perform plowing in an alternating pattern. For the sections (8) to (19), plow in a circular pattern.
- Refer to the sequential returning pattern for other details.

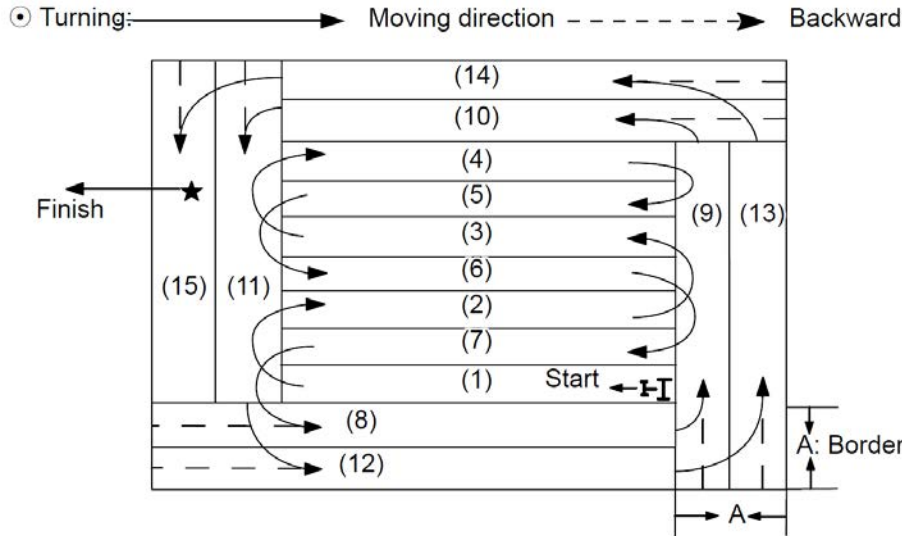

3. Land leveling pattern

- The land leveling work may be performed after crushing soil or not.
- The vehicle speed can be set faster when performing the land leveling work with soil crushed already.
- When working in a wet field, fill the field with a sufficient amount of water so that the trace of plowing cannot be seen.
- The border shown in the figure should be set a little narrower than two times of one plowing width.
- Refer to the alternating returning pattern for other details.

D



9. OPERATION TIPS

To save fuel & oil in your tractor, following things should always be kept in mind.

► AIR CLEANING SYSTEM

1. Clean the air cleaner regularly so that dust does not settle down.
2. For every 50 hours & everyday in sandy/dusty conditions.
 - Clean the air cleaner filter element with compressed air.
 - If the rubber ring is cut or expanded then change it with an appropriate one.
Fix the rubber at the proper location & check for leakages if any.
 - If air is leaking through the hose connection, check & rectify other leakages, too.

❏ IMPORTANT

- If air cleaning system is not properly maintained, it will lead to early wear of piston rings & sleeves. This will lead to problems like loss of engine power, excessive oil consumption fuel consumption.

► ENGINE

1. Put the engine oil on load after the engine is heated & the water temperature gauge indicates the needle to be in the green zone.
2. If excessive black smoke is visible, then the paper element of air cleaner, Fuel injection pump or nozzles should be checked.
3. Do not run the engine without load for more than 2 minutes. It is better to stop the engine rather than run it idle. This will help in saving of fuel.

► BRAKE

1. If the tractor has to be stopped for a long period, it is advisable to bring the transmission in neutral position.
2. Do not override the brake pedals.
3. While coming down from a slope, reduce the engine throttle & use low gear.
Do not depend only on the brakes for stoppage.

► OIL SYSTEM

1. Always use recommended grade of oil.
2. Everyday before starting the engine, check the oil level with a dipstick & refill between the minimum & maximum level.
3. Change the engine oil.
Replace filter & O-ring, as & when required.

► LUBRICATING OIL**• GENERAL**

Modern diesel engines place very high demands on the lubricating oil to be used. The specific engine performances which have increased constantly over the last few years lead to an increased thermal load on the lubricating oil. The lubricating oil is also more exposed to contamination due to reduced oil consumption and longer oil change intervals. For this reason it is necessary to observe requirements and recommendations described in this operating manual in order not to shorten the life of the engine. Lubricating oils always consist of a base oil and an additive package. The most important tasks of a lubricating oil (e.g. wear protection, corrosion protection, neutralization of acids from combustion products, prevention of coke and soot deposits on the engine parts) are assumed by the additives. The properties of the base oil are also decisive for the quality of the



product, e.g. with regard to thermal load capacity. In principle, all engine oils of the same specification can be mixed. However, mixing of engine oils should be avoided because the worst properties of the mixture are always dominant.

• VISCOSITY

The ambient temperature at the installation site or in the application area of the engine is decisive for choosing the right viscosity class. Too high a viscosity can lead to starting difficulties, too low a viscosity can endanger the lubrication effect and cause high lubricating oil consumption. The viscosity is classified according to SAE. Multipurpose lubricating oils should be used basically.

IMPORTANT

- The prescribed lubricating oil quality must be observed when selecting the viscosity class.

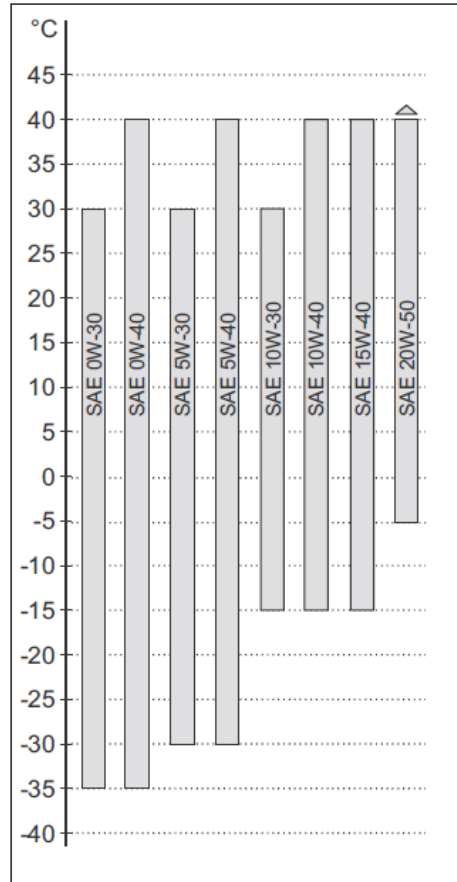

1. Always use filtered diesel for the fuel system.
2. At the end of the day's working, it is preferable to fill the diesel tank so that it may prevent condensation.
3. Change the filter, if the system gets choked.

Do not change both the filters at the same time.

If the above directives are not adhered to, the fuel injection pump & injection nozzle will lose its life early.

Also, it will lead to excessive black smoke & excessive diesel consumption.

※ Please refer to 「APPENDIX」 chapter for more details of diesel fuel.

► WINTER OPERATION WITH DIESEL FUEL

Special demands are placed on the cold behavior (temperature limit value of the filterability) for winter operation.

Suitable fuels are available at filling stations in winter.

At low ambient temperatures paraffin discharges can lead to blockages in the fuel system and cause operating faults.

IMPORTANT

- For engines with common rail injection, the mixing of petroleum and adding of extra low additives is not permissible.

► COOLING SYSTEM

1. Check the fan belt tension regularly. Adjust, if required.
2. Check the coolant level in the radiator fins always clean.
3. Replace the radiator cap with a genuine cap only, if required.
4. Do not remove the thermostat but replace with a new one, if required.
5. Do not change the radiator water often.
※ Please refer to 「APPENDIX」 chapter for more details of coolant.

► OTHERS

In liquid-cooled engines, the coolant must be conditioned and monitored, otherwise the engine could be damaged by:

- Corrosion
- Cavitation
- Freezing
- Overheating

10. HOW TO USE OF THE JACK

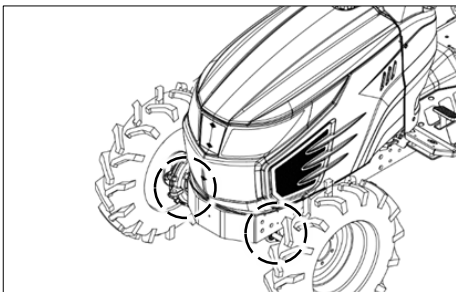

- If the tractor must be lifted for servicing, take it to a suitably equipped workshop.
- Carry out the following operations before any operation about the tractor.
Engage the four-wheel drive, the first gear and the parking brake and put chocks to the wheels touching the ground.
- Before lifting the tractor, avoid its swinging by means of wooden wedges applied to the front axle
- Use jack lifts of suitable capacity and apply them at the center of the front and rear axles and paying due attention to weight distribution.

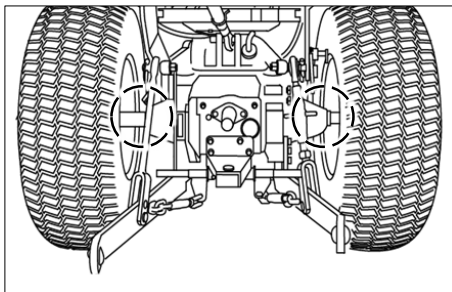

- No decals for the lifting point are applied on the tractor, as they would be, too difficult to apply in the available spaces and would be all too easily removed or effaced during normal operation of the tractor.

IMPORTANT

- Apply the jack lift to the lifting points according to the type of operation and following the safety procedures given before.



E. MAINTENANCE

1. MAINTENANCE SCHEDULE E – 2
2. OPENING COVERS E – 4
3. CHECKS & SERVICING EACH PART E – 5
4. GREASING EACH PART E – 15
5. STORING THE TRACTOR E – 16



1. MAINTENANCE SCHEDULE

▶ PERIODICAL CHECK AND SERVICE SCHEDULE TABLE

■ Check or adjust each part only when engine is stopped.
 ■ When any hot part should be serviced, wait until it is cooled down.

○ : Check · Add · Adjust ● : Replace
 ★ : Replace at first time only △ : Clean

INSPECTION PART	TIME OF USE											YEAR		REMARK	
	50	100	150	200	250	300	350	400	450	500	550	1	2		
ENGINE OIL LEVEL	CHECK ENGINE OIL LEVEL BEFORE WORK														
ENGINE OIL & FILTER	★					●					●	●		EVERY 250HR OR 1 YEAR	
FUEL FILTER										●					
FULE HOSE & BAND										○			●	EVERY 2 YEAR	
AIR CLEANER ELEMENT		△		△		△		△		●				EVERY 500HR	
AIR CLEANER HOSE & BAND										○			●	EVERY 2 YEAR	
INLET HOSE & BAND										○			●	EVERY 2 YEAR	
COOLANT													●	EVERY 2 YEAR	
COOLANT LEVEL	CHECK COOLANT LEVEL BEFORE WORK														CHECK BEFORE WORK
RADIATOR & RADIATOR NET	CLEAN RADIATOR & RADIATOR NET BEFORE WORK														CLEAN BEFORE WORK
RADIATOR HOSE & BAND										○			●	EVERY 2 YEAR	
FAN BELT & A/C BELT					○					○				IF IT IS NEEDED	
BATTERY		○		○		○		○		○				IF IT IS NEEDED	

Check or adjust each part only when engine is stopped.
When any hot part should be serviced, wait until it is cooled down.

○ : Check·Add·Adjust ● : Replace
 ★ : Replace at first time only △ : Clean

INSPECTION PART	TIME OF USAGE																REMAKRS
	Daily	50	100	150	200	250	300	350	400	450	500	550	600	1year	2year		
TRANSMISSION & HST OIL		★					●					●		●		EVERY 250HR or 1 YEAR	
FRONT AXLE OIL		★					●					●		●			
STRAINER		○						○									
STATE OF BRAKE PEDAL	○																
OPERATION OF LEVERS	○															Smooth operation	
FREE PLAY OF STEERING WHEEL	○															50mm(1.97in) of wheel circumference	
TOE-IN	GET SERVICED BY WORKSHOP EVERY 300HR																
GREASE IN FRONT WHEEL HUB							○										
CHECK THE STEERING WHEEL JOINT							○						○				
WHEEL NET FASTENING TORQUE	○																
LOOSE BOLTS AND NUTS	○															Loose or broken terminals, missing wiring. Check correctly clamped.	
OPERATION OF THE INSTRUMENTS	○																
GREASE EACH NIPPLE		○	○	○	○	○	○	○	○	○	○	○	○				
OIL OF 4WD FRONT AXLE		★										●	●				
CHECK ELECTRIC WIREING	○																
HYDRAULIC HOSES&PIPES							○										

C
H
A
S
S
I
S

E

2. OPENING COVERS

▶ OPENING HOOD

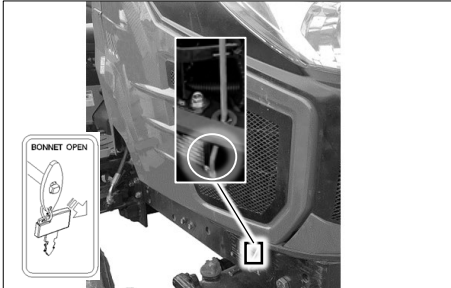

Follow the next steps to open the hood.

1. Use the key to pull the hood lock pin to unlock.
2. Lift up the hood until it is fixed at its position.

▶ CLOSING HOOD



Follow the next steps to close the hood.

1. Lift the hood slightly to release the latch.
2. Lower the hood until it is locked firmly.

▶ OPENING SIDE COVERS

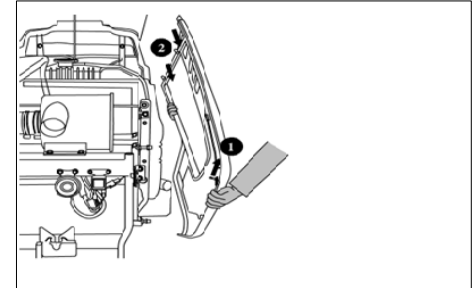

Follow the next steps to open the side covers.

1. Grab the slide cover and pull the forward panel upward to separate from guide pin.
2. Pull the side panel forward again.

3. CHECKS & SERVICING EACH PART

► COOLANT CHECK

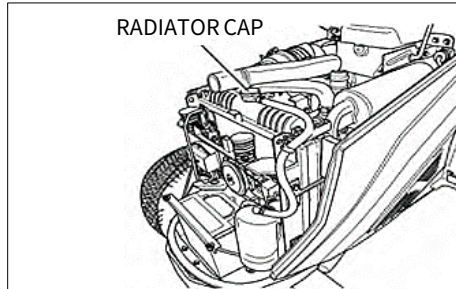

Remove the radiator cap and ensure that the coolant is up to the filler neck and that it is clean with the correct anti-freeze or anti-corrosion inhibitor in it.

If the coolant is in rusty color, drain the system completely and refill it with the correct mixture of water and anti-freeze or corrosion inhibitor.

► COOLANT CHANGE

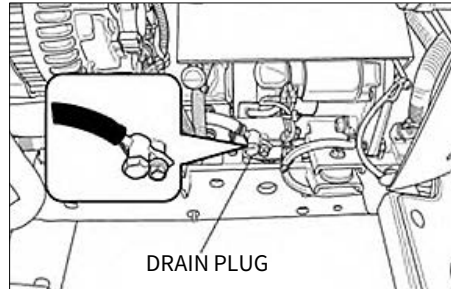

Follow next steps to change coolant.

1. Open to drain cock.
2. Open the radiator at the same time.
3. To give a thorough clean, run a hose into the radiator and flush it out.
4. Close the tap and refill the radiator with a coolant mixture of water and corrosion inhibitor or anti-freeze.
5. Start the engine and allow it to run for approx. 5 minute, check the water level again and top off if required.

► ANTI-FREEZE

If coolant freeze, the engine can be damaged.

Please ensure followings.

- Clean the radiator before adding antifreeze.
- Mixture ratio of antifreeze is different by manufactures and temperature. Follow the guide of manufacture's manual.
- Adding antifreeze in case of;
 - If evaporated : Add water for reduced amount.
 - If leaked : Add mixture of antifreeze and water with same mixture ratio.

▶ **ENGINE OIL CHECK**

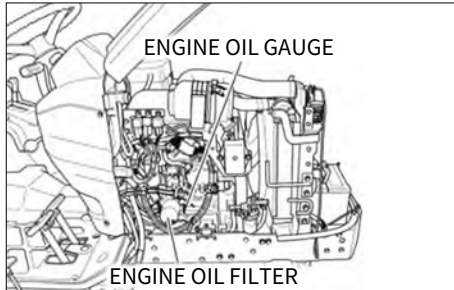

Follow next steps to check engine oil.

1. Pull out the stick, wipe it and dip it in the oil sump.
2. Ensure that the oil level is between the upper and lower marks near the upper mark.
3. If it's too low add oil, but never after the 100hrs service interval.

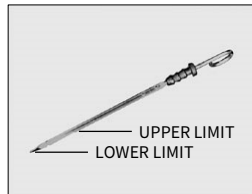

<DIP STICK>

▶ **ENGINE OIL CHANGE**



Follow next steps to change engine oil.

1. Park tractor on a level surface, shut-off the engine and remove the sump plug & drain oil.
2. Replace and check the sump plug and refill the engine with oil to the correct level on the dipstick. The grade of oil to be used will depend on the ambient temperature.
3. Check the level with dip stick.

CAUTION

- If engine oil gets on your skin, it can irritate the skin and cause a skin condition.
Make sure to clean your skin with soap and water or hand cleaner.
- Make sure to cool down the engine sufficiently before draining oil. Oil is very hot and can cause a burn if changing oil right after the engine is stopped.
- Check engine oil level after filling it.

IMPORTANT

- Do not add engine oil over upper limit level.
- When trying to use new oil from a different manufacture or oil with different viscosity, drain used oil completely before adding new oil.
- Please refer to 「APPENDIX」 chapter for engine oil specification and capacity.

▶ TRANSMISSION OIL CHECK

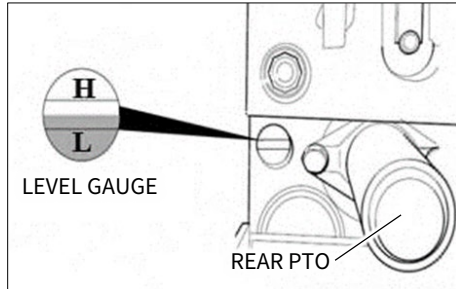

Follow next steps to check transmission oil.

1. Ensure the engine is stopped.
2. Check transmission oil level through the sight glass to see whether the oil level is between upper and lower limits.
3. If insufficient, add transmission oil.

▶ TRANSMISSION OIL CHANGE

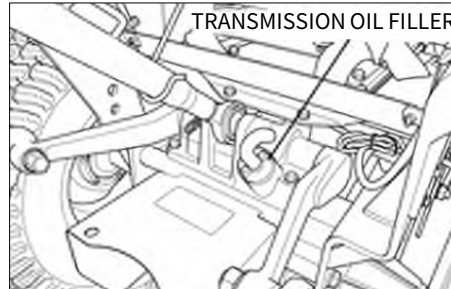

Follow next steps to change transmission oil.

1. Unscrew the drain plug on the lower section of the transmission to drain contaminated transmission oil.
Since hot oil flows out of the engine first, be careful not to get burnt.
2. After draining oil, tighten the drain plug.
3. Add specified amount of transmission oil through the filling hole.
4. Check transmission oil level after filling it.
5. Check the level with level gauge.

 CAUTION

- If transmission oil gets on your skin, it can irritate the skin and cause a skin condition.
Make sure to clean your skin with soap and water or hand cleaner.
- Make sure to cool down the engine sufficiently before draining oil.
Oil is very hot and can cause a burn if changing oil right after the engine is stopped.
- Check transmission oil level after filling it.

 IMPORTANT

- Do not add transmission oil over upper limit level.
- When trying to use new oil from a different manufacture or oil with different viscosity, drain used oil completely before adding new oil.
- Please refer to 「APPENDIX」 chapter for engine oil specification and capacity.

E

▶ FRONT AXLE OIL CHECK

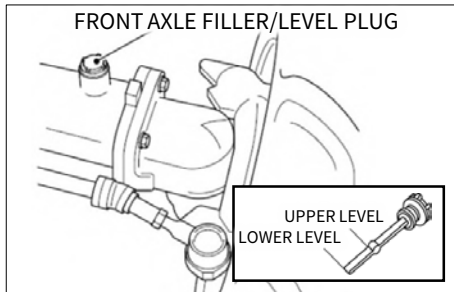

Follow the steps below to check front axle oil.

1. Park the tractor on level surface.
2. Lower the implements and shut off the engine.
3. Remove front axle oil cap.
4. Wipe the dip stick on oil cap, dip and screw oil cap into front axle oil filling hole.
5. Unscrew oil cap and pull out
6. Check the level with dip stick. If the level is low, add more oil through filling hole.

▶ FRONT AXLE OIL CHANGE

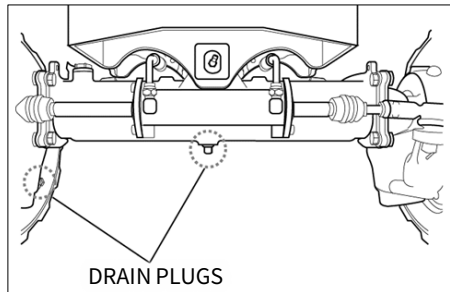

Follow the steps below to change front axle oil.

1. Park the tractor on level surface.
2. Lower the implements and shut off the engine.
3. Remove front axle oil cap.
4. Remove front axle drain plug at bottom of front axle case and front of both spindles.
5. Drain front axle oil completely.
6. Reinstall drain plugs.
7. Fill with new front axle oil to correct level through filling hole.
8. Reinstall front axle oil cap.
9. Check the level with dip stick.

⚠ CAUTION

- Always ensure that you use the correct oil for topping up or oil changes.
- Check front axle oil level after filling it.

📖 IMPORTANT

- Please refer to 「APPENDIX」 chapter for front axle oil specification and capacity.

► **AIR CLEANER DUST VALVE**

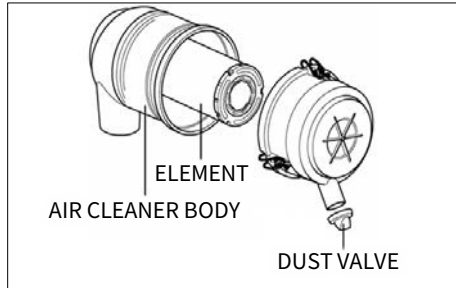

Check that the dust valve is not blocked. Inspect the rubber flaps for cuts and nicks and check that the rubber is not perished.

Renew if necessary.

To remove dust from the dust valve, squeeze it between thumb and fingers. Wipe around the dust valve to remove dust collected on the outside.

► **AIR CLEANER CLEANING**

Release the two clips on the air cleaner end cover and remove the element. Remove dust by blowing compressed air through the element.

Check the element for damage, if necessary, change the elements.

Check all hoses for condition and tightness.

IMPORTANT

- Never beat the element on a stone or concrete floor/wall to clean it.
- Check all connections and hoses especially on the clean side of the air cleaner to ensure no dusty air can enter the engine.
- Check the element for flaws by putting a light inside the element.
- When reassembling, make sure all surfaces seal correctly to keep dust out.
- When working in dusty conditions, increase the service frequency.

► **CLEANING FUEL FILTER**

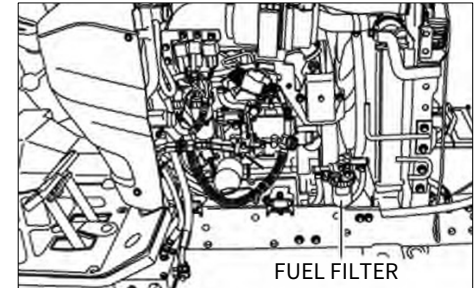

Follow the next steps to clean the fuel filter.

1. Close the fuel cock.
2. Remove the fuel filter element.
3. Wash the fuel filter element in clean diesel fuel. If necessary, replace it.
4. Fit a cleaned or new fuel filter element.
5. Open the fuel cock.
6. Bleed the fuel system.

IMPORTANT

- Never use petrol (gasoline) thinner or similar inflammable material to wash the primary fuel filter.
- After replacing the filter always bleed the system.

E

► **CHANGE ENGINE OIL FILTER**

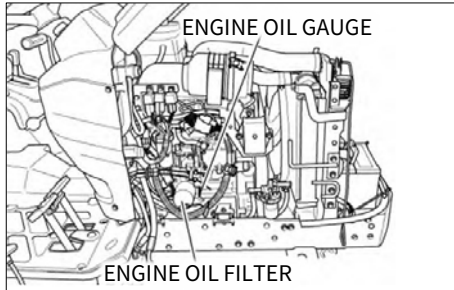

Follow the steps below to change engine oil filter.

1. Remove the oil filter using a filter wrench.
2. Smear lightly the rubber seal on the new filter with oil to ensure.
3. Turn the filter clockwise until the seal contacts the base and then turn it another 2/3 turn to tighten it.

IMPORTANT

- Always use the same oil, as using different oils or specifications can cause damage.
- Dispose off the old oil as per local regulations.

► **BLEEDING FUEL SYSTEM**

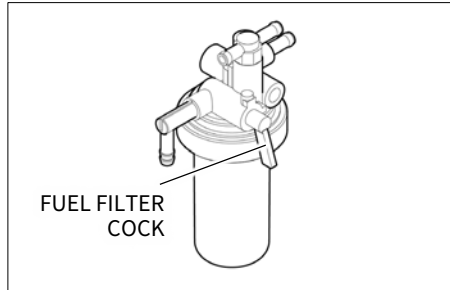

Follow next steps to bleed fuel system.

1. Fuel filter cock 「ON」 .
2. Open the cock on the fuel injection pump.
3. Fill the tank with fuel and turn on the ignition key.
4. Start the engine and allow it to run for a while.
5. Close the fuel injection pump cock. The bleeding of the system is now finished.

► **CLEANING OIL WATER SEPARATOR**

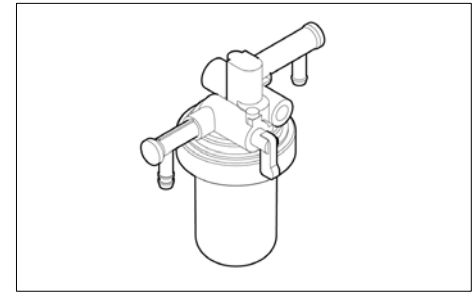

If any foreign material or water is seen through the sight glass, remove it by performing the following steps.

1. Prepare a container to collect fuel from the oil water separator.
2. Open the drain plug.
3. After a sufficient amount of fuel is drained, tighten the drain plug with a hand.

Do not use any tool.

► **FANBELT ADJUSTMENT**

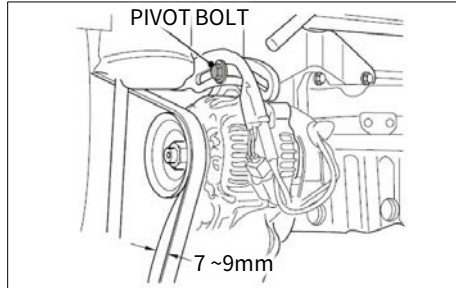

Follow next steps to adjust fanbelt.

1. Loosen the alternator pivot bolt.
2. Move the alternator in order to increase or decrease the belt tension.
3. Tighten the alternator pivot bolt and the link bolt to 22 N.m (16lb ft).

► **HOSES AND CLAMPS**

The fuel lines, radiator, hydraulic, air cleaner and rubber hoses are consumables, which deteriorate by age and use.

Check them regularly and replace if they are damaged.

 **CAUTION**

- Damaged fuel lines leak and cause fires.
- Damaged radiator hoses can cause hot water burns and in severe cases seize the engine.

 **IMPORTANT**

- Fuel pipes and wiring age with use.
- Ask your dealer to check it at least once every 2 years and replace as required.

► **BRAKE PEDAL FREE PLAY**

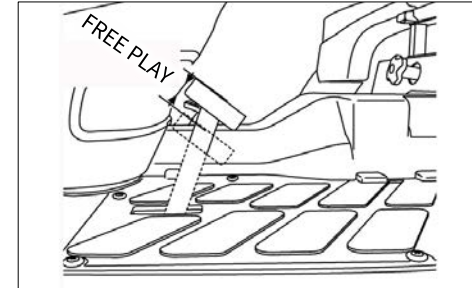

Use of the brakes will change the pedal free play and the balance between the right and left pedal.

The correct pedal free play is 30 ~ 40mm.

<Adjustment>

1. Loosen the locknuts at each end and turn the rod to adjust the brake.
2. Turning it anticlockwise increases the free play, clockwise decreases it.
3. Tighten the locknuts.
4. Check that the free play is correct.

E



▶ ADJUSTING THROTTLE LEVER, TOE-IN

• THROTTLE LEVER

If this lever is either loose or difficult to move, please consult your workshop for rectification of the problem.

• TOE-IN

If the toe-in adjustment is incorrect it can cause severe shaking of both the steering wheel and the entire tractor. The correct toe-in is 2 ~ 6mm. (0.78 ~ 0.23 in.)

We recommend that the adjustment is made by the workshop.

▶ BATTERY CHECK

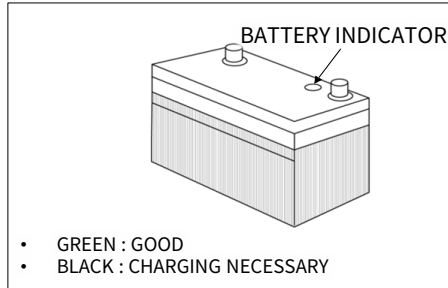

The original battery is maintenance free. But the water in the electrolyte can evaporate during use. So it needs to service for longer life.

The electrolyte level of the battery can evaporate during use thus lowering the level. Where it does so replace it with distilled water. Where a spillage has reduced the level, replace it with electrolyte.

⚠ CAUTION

- Electrolyte contains acid and can cause serious burns.
- Any spillage on skin should be washed off by water immediately.

▶ BATTERY MAINTENANCE

- Low temperatures will affect the performance of batteries so take particular care of it in winter.
- For long-term storage of the tractor, remove the battery and keep it in a cool dry room.

If it is on the tractor while stored, disconnect the negative terminal.

- Batteries will self-discharge if left for a period of without use time.
- To keep them in good condition charge them once a month in summer and every second month in winter.
- When replacing the original battery, ensure that the replacement battery is the same size.
Failure to do so can cause problems with the electrical circuit.

⚠ IMPORTANT

- Low electrolyte levels can cause premature battery failure and corrosion.

► BATTERY JUMP START

1. Turn off all electric devices.
2. Connect positive terminal of normal battery to the positive terminal of discharged battery with jump cable.
3. Connect the negative terminal of the normal battery to the engine body of the tractor for discharged battery with the jump cable.
4. Firstly, start the engine of the vehicle with the normal battery. Then, start the engine of the tractor with the discharged battery.
5. After the engine is started, disconnect the negative cable first. Then, disconnect the positive cable.
6. Charge the discharged battery for approx. 30 minutes after the engine is started.

CAUTION

- Make sure to connect positive terminal first and connect negative terminal to the engine body of the tractor with the discharged battery.

► BATTERY DISCONNECTING SWITCH

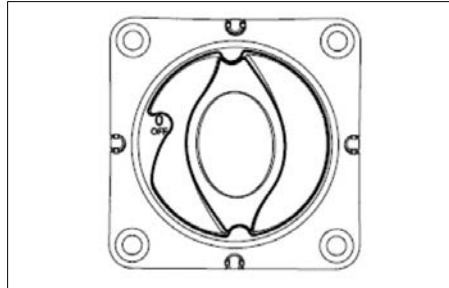

The function of the battery disconnect switch is to disconnect the power supply to the electrical system by interrupting the connection to the battery.

This has benefits for tractor safety and operation, in particular:

1. Protects the electrical system against short circuit;
2. Reduces battery self-discharge when the tractor is left idling for prolonged periods;
3. Allows maintenance and repairs to be carried out in conditions of safety.

- Turn the knob to “OFF” to disconnect the battery and back to “ON” to resume normal operation.
- The battery disconnect knob (1) is located on the bracket to the right of the battery.

The battery disconnect knob may be removed for safety purposes in the manner described below.

<Removal of the knob>

Press the knob in and continue to turn it counter-clockwise as far as it will go.

<Refitting the knob>

Press and turn the knob clockwise, positioning it at "ON".

▶ HARNESS AND FUSES CHECK

Loose wires make inferior connections and damaged wires can cause short circuits, fires burnt wiring or reduce efficiency of components.

Replace or repair any faulty wiring or insulation.

If a fuse burns out again after it has been replaced, do not replace it with wire or a high capacity fuse, find the cause and rectify it or get auto electrician to do so. Where insulation is chafed or peeled off, recover the area with a good quality insulation tape.

Where wiring comes out of it's fitting replace it correctly with the standard fitting.

❏ IMPORTANT

- Incorrect wiring or fuses can cause fires to both the tractor and surrounding area so get the dealer to check it annually. Likewise fuel pipes and wiring age with use.
- Ask your dealer to check it at least once every 2 years and replace as required.

▶ FUSE REPLACING

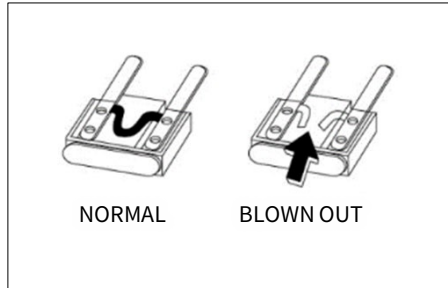

The circuit has blade type fuses in its wiring circuit.

When a fuse has blown replace it with one of the same value.

Using a large capacity fuse or wire burn out the wiring system.

Use fuse tongs to replace fuses.

❏ IMPORTANT

- Always check the reason for a blown fuse otherwise the new fuse is also likely to blow.
- NEVER EVER USE A WIRE in place of correct grade fuse.

▶ MAIN FUSES

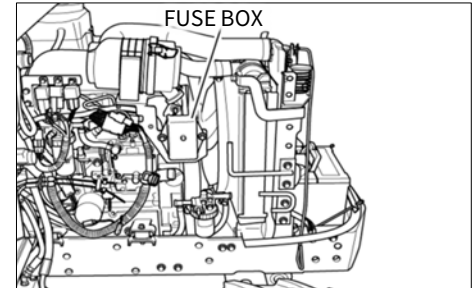

The wiring harness is equipped with main fuses whose function is to preserve the wiring.

However when a main fuse blows the entire circuit is dead.

Always check the reason & rectify before replacing the fuse of the same value.

To indicate that the fuse is blown it will be discolored.

4. GREASING EACH PART

► GREASING AND DRAIN POINTS

► GREASING BRAKE ARM

Remove the rubber caps on the floor and dash panel to access to the grease nipple.

Add grease with a grease gun.

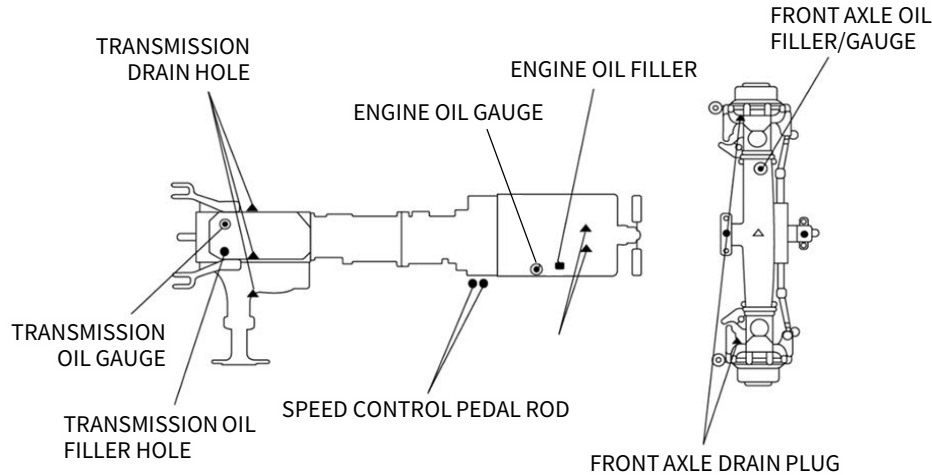

○ FILLER HOLE ● GREASE NIPPLE ▲ DRAIN HOLE ■ CHECK HOLE

E



5. STORING THE TRACTOR

► DAILY STORAGE

1. Store the tractor after cleaning it. Especially, clean it thoroughly after harrowing or working in a wet field.
2. Make sure to lower an implement.
3. Store the tractor indoors if possible.
4. If storing the tractor outside, cover it.
5. For better start-ability, it is recommended to remove the battery from the tractor and keep it indoors in winter.
6. If the outside temperature is below 0°C, add antifreeze or drain coolant completely to prevent the engine from freezing and bursting.
7. Remove the key and store it separately.

► LONG-TERM STORAGE

Clean the tractor thoroughly and store it as follows:

1. Change engine oil with new oil and run the engine for 5 minutes to distribute oil to each part evenly.
2. Drain coolant from the radiator. Then, make a label indicating "No Coolant" and fix it onto the steering wheel. If antifreeze is already added, it is not necessary to drain coolant.
3. Add oil, fluid and fuel to each part according to the maintenance chart.
4. Apply a thin film of grease or oil to body parts that are apt to rust.
5. Check each bolt and nut for looseness and tighten any loose bolt and nut.
6. Set the tire inflation pressure a little higher than the specification.
7. Remove a weight. Detach or lower an implement.
8. Chock the rear wheels.
9. Remove the battery from the tractor or turn off its switch to cut power connection.
10. Place wood blocks under the tires to protect them.
11. Charge the battery every 2 months during long-term storage.
12. Store it in a dry place to avoid rain or snow and cover the body.

► **USE AFTER LONG-TERM STORAGE**

Keep the following instructions when using the tractor after its long-term storage.

1. Inspect the tractor thoroughly before driving it.
2. To keep performance and life of the engine, idle the engine for approx. 30 minutes after starting it.

 **CAUTION**

- If leaving the battery connected to the tractor, turn off its switch to cut electric power.
- If wiring is damaged by rodents, its short circuit can start a fire.

 **IMPORTANT**

- For engine lubrication, run the engine at 1,500 ~ 2,000 RPM for 5 to 10 minutes once a month.
- Remove the key from the tractor and store it separately.

► **USAGE AND DISPOSAL**

It is recommended to keep the followings to protect the environment:

1. Avoid overloading work as it can lead to incomplete combustion and emissions that can pollute the air.
2. When changing oil, including engine oil, transmission fluid, hydraulic oil and coolant, be careful not to spill it and discard used oil according to the applicable law. Used oil should be treated with care and discarded properly as it can contaminate soil and water.
3. When this or other machine's life is expired, do not neglect or discard it on your own, but contact your dealer so that the approved service provider can discard the machine according to the laws.



F. TROUBLESHOOTING

1. ENGINE TROUBLESHOOTING F – 2
2. BRAKE TROUBLESHOOTING F – 5
3. STEERING WHEEL TROUBLESHOOTING F – 6
4. HYDRAULIC SYSTEM TROUBLESHOOTING · F – 6
5. ELECTRIC INSTRUMENTS
TROUBLESHOOTING F – 7

1. ENGINE

	ISSUE	CAUSE	ACTION
E N G I N E	The start motor does not rotate when the key switch is turned	<ul style="list-style-type: none"> • PTO switch is on 「ON」 position • Defective safety switch • Battery discharged • Loose terminal • Faulty key switch • Defective start motor 	<ul style="list-style-type: none"> • Set PTO switch into 「OFF」 position • Have it repaired or replaced by workshop • Charge battery • Check for looseness and corrosion Clean, tighten and apply grease • Have it repaired or replaced by workshop • Have it repaired or replaced by workshop
	The start motor runs, but its speed cannot be increased	<ul style="list-style-type: none"> • Weak battery • Poor ground • Incorrect viscosity of engine oil 	<ul style="list-style-type: none"> • Charge battery. • Clean contact and connect ground firmly • Change engine oil with proper viscosity
	The start motor runs, but engine cannot be started	<ul style="list-style-type: none"> • Air in fuel system • Clogged fuel filter • No fuel supply • Defective engine • Defective key stop unit 	<ul style="list-style-type: none"> • Bleed the system • Clean or replace the filter • Open the cock and add fuel • Have it repaired or replaced by workshop • Have it repaired or replaced by workshop
	Engine runs irregularly	<ul style="list-style-type: none"> • Air in fuel system • Clogged fuel filter • Clogged injection nozzle • Fuel leak from pipe • Poor fuel injection 	<ul style="list-style-type: none"> • Bleed the system • Clean or replace the filter • Have it repaired or replaced by workshop • Tighten clamp, replace pipe or machine surface of copper washer before installation • Have it repaired or replaced by workshop
	Engine stops at low speed	<ul style="list-style-type: none"> • Defective injection pump • Incorrect engine valve clearance • Low idle speed • Faulty nozzle 	<ul style="list-style-type: none"> • Have it repaired or replaced by workshop • Have it repaired or replaced by workshop • Adjust speed to the rated speed • Have it repaired or replaced by workshop

	ISSUE	CAUSE	ACTION
E N G I N E	The engine overruns	<ul style="list-style-type: none"> • Clogged governor by foreign material or dust • Oil increased 	<ul style="list-style-type: none"> • Have it repaired or replaced by workshop • Have it repaired or replaced by workshop
	The engine stalls suddenly	<ul style="list-style-type: none"> • Insufficient fuel • Faulty nozzle • Engine seizure by insufficient oil or poor lubrication 	<ul style="list-style-type: none"> • Add more fuel and bleed the system • Have it repaired or replaced by workshop • Have it repaired or replaced by workshop • Pull the fan belt. <p>If crank pulley is moved, it may indicate insufficient fuel and faulty nozzle</p>
	The engine is overheated	<ul style="list-style-type: none"> • Insufficient coolant amount • Loose or damaged fan belt • Clogged radiator • Insufficient engine oil 	<ul style="list-style-type: none"> • Add coolant • Adjust fan belt tension or replace it • Clean radiator • Inspect and replenish
	The engine produces white or black smoke	<p>White smoke</p> <ul style="list-style-type: none"> • Clogged air cleaner • Excessive engine oil amount • Insufficient fuel delivery amount <p>Black smoke</p> <ul style="list-style-type: none"> • Low quality fuel • Excessive fuel amount delivery • Insufficient nozzle pressure 	<p>White smoke</p> <ul style="list-style-type: none"> • Clean air cleaner element • Check and set the proper amount • Have it repaired or replaced by workshop <p>Black smoke</p> <ul style="list-style-type: none"> • Add specified fuel • Have it repaired or replaced by workshop • Have it repaired or replaced by workshop

F

	ISSUE	CAUSE	ACTION
E N G I N E	The engine power is insufficient	<ul style="list-style-type: none"> • Clogged or carbon on nozzle tip • Insufficient compression or gas leak from valve seat • Incorrectly adjusted valve clearance • Incorrect injection timing • Insufficient fuel • Clogged air cleaner • Urea supply shortage 	<ul style="list-style-type: none"> • Have it repaired or replaced by workshop • Have it repaired or replaced by workshop • Have it repaired or replaced by workshop • Have it repaired or replaced by workshop • Add more fuel • Clean the air cleaner element • Add more urea
	The oil warning lamp comes on during driving	<ul style="list-style-type: none"> • Low engine oil level • Low viscosity of engine oil • Faulty pressure switch • Defective oil pump • Oil filter element clogged 	<ul style="list-style-type: none"> • Add engine oil to specified level • Change oil with proper viscosity • Replace the switch • Have it repaired by workshop • Replace the element
	The charge warning lamp comes on during driving	<ul style="list-style-type: none"> • Defective wiring • Defective alternator • Defective battery or insufficient distilled water • Loose or damaged fan belt 	<ul style="list-style-type: none"> • Check for loose or missing terminal, short circuit and poor ground and repair as necessary • Have it repaired by workshop • Replace the battery or add distilled water • Adjust the tension or replace the belt

2. BRAKE

	ISSUE	CAUSE	ACTION
B R A K E	Brake does not operate or brake on one side operates only	<ul style="list-style-type: none">• Excessive brake pedal free play• Worn or seized liner• Different play of left and right pedals	<ul style="list-style-type: none">• Adjust the free play• Have it repaired by workshop• Set the left and right free play to the same
	The brake pedal does not return to its original position properly	<ul style="list-style-type: none">• Damaged brake return spring• No grease on sliding part	<ul style="list-style-type: none">• Replace the spring• Remove rust and apply grease

3. STEERING WHEEL

	ISSUE	CAUSE	ACTION
S T E E R I N G	The steering wheel feels heavy or The steering wheel vibrates	<ul style="list-style-type: none"> • Improper toe-in • Incorrect tire inflation pressure • Vibration from each connection 	<ul style="list-style-type: none"> • Adjust toe-in • Set left and right tires to same specified pressure • Tighten or replace connection
	The free movement of steering wheel is excessive	<ul style="list-style-type: none"> • Worn steering wheel shaft • Worn metal parts • Free play from each connection 	<ul style="list-style-type: none"> • Have it repaired by workshop • Have it repaired by workshop • Tighten free play of each connection

4. HYDRAULIC SYSTEM

	ISSUE	CAUSE	ACTION
H Y D R A U L I C	Oil leaks from the pipe or hose	<ul style="list-style-type: none"> • Loose clamps • Cracked pipes 	<ul style="list-style-type: none"> • Tighten clamps • Have it replaced by workshop
	Hydraulic pressure won't be decreased	<ul style="list-style-type: none"> • Lowering speed control lever fixed • Defective valve • Damaged cylinder • Damaged and seized lift shaft rotating part 	<ul style="list-style-type: none"> • Set it to the lowering position • Have it repaired by workshop • Have it repaired by workshop • Have it repaired by workshop
S Y S T E M	The hydraulic pressure won't be increased	<ul style="list-style-type: none"> • Insufficient engine RPM • Insufficient transmission fluid • Air sucked into suction pipe • Clogged oil filter • Defective hydraulic pump • Defective valve • Damaged cylinder 	<ul style="list-style-type: none"> • Set the speed to 1,000 to 1,5000 RPM • Add to the specified level • Tighten the connection. • If any pipe or hose is cracked or O-ring is damaged, replace them. • Have it repaired by workshop • Have it repaired by workshop • Have it repaired by workshop

5. ELECTRIC SYSTEM

	ISSUE	CAUSE	ACTION
E L E C T R I C S Y S T E M	The battery won't be charged	<ul style="list-style-type: none"> • Blown fusible link • Defective wiring • Defective alternator • Loose or damaged fan belt • Defective battery function 	<ul style="list-style-type: none"> • Check the wiring and replace the fusible link • Check for loose or missing terminal, short circuit and poor ground and repair as necessary • Have it repaired by workshop • Adjust the tension or replace the belt • Check for loose or corroded terminal and insufficient electrolyte and take any necessary action
	The headlamp does not produce enough light	<ul style="list-style-type: none"> • Low charging level of battery • Contact failure in wiring 	<ul style="list-style-type: none"> • Charge • Check, clean and re-tighten the ground and terminal
	The headlamp does not come on	<ul style="list-style-type: none"> • Blown bulb • Blown fuse • Contact failure 	<ul style="list-style-type: none"> • Replace the bulb • Check the wiring and replace the fuse • Check and clean the ground and terminal
	The horn does not operate	<ul style="list-style-type: none"> • Defective horn switch • Defective wiring • Damaged horn 	<ul style="list-style-type: none"> • Replace • Repair • Repair or replace
	The turn signal lamp does not blink	<ul style="list-style-type: none"> • Blown bulb • Defective flasher unit • Poor contact 	<ul style="list-style-type: none"> • Replace the bulb • Replace • Check and clean the ground and terminal
	The work lamp does not come on	<ul style="list-style-type: none"> • Blown bulb • Contact failure 	<ul style="list-style-type: none"> • Replace the bulb • Check and clean the ground and terminal

F



G. STANDARD FOR FARMWORK

TO ENSURE SAFE AGRICULTURAL WORK, SAFETY PRECAUTIONS FOR USE OF AGRICULTURAL MACHINERY ARE SET BY THE NATIONAL INSTITUTE OF AGRICULTURAL ENGINEERING.

READ THIS INFORMATION THOROUGHLY ALONG WITH THE USER MANUAL TO ENSURE SAFE WORK.



1. STANDARD FOR FARMWORK

▶ SAFETY MARK

Always make sure to check the operating condition of the safety lamp (such as turn signal lamp) before operating the machine.

※ If any lighting system is removed※ It may lead to an unexpected accident because it is not possible to give signals to people or machine nearby.

▶ INSTRUCTION BEFORE USE

Operator must attend his/her health and should get enough rest.

Before using the machine, check it and repair if there is a malfunction.

- Check if the assembly of front and rear wheels is okay.
- Check the tightening of bolts and nuts in each unit.

Do not drive if you are mentally unstable, drunk, pregnant, under the age of 16, not trained, overworked, sick, under the influence of drugs, and any other reason that may affect normal operation of the machine.

Please wear the appropriate working clothing.

- Put on a hard hat to protect your head.
- Put on a hat and a working clothes, to prevent an injury such as being twined into the machine.

- Protective measures to prevent any injury on foot or slipping - Put on an appropriate non-slippery shoes to prevent a fall from the machine, scattering soil, and slippery surface.
- Measures against dust and toxic gas.
- Wear an appropriate protective gear.
- Measures against the herbicide : wear protective gear to protect respiratory system, eyes and skin.
- Measures against noise : wear a protective gear to protect your ears.
- Handling protective gear : do neither let children get on the machine nor get close to the machine.

If it is not possible to park the agricultural machine on a road either due to a breakdown or any other reason, operator must take an action such as moving the equipment to a place other than a road.

Also, put a signal that there is a broken car, 100m behind and 200m at night in accordance with Automobile Regulation Article 23.

When starting to drive, make sure to check around carefully.

- Do not let anyone such as a child get close to the machine, keep them away and then drive the machine.

Do not load flammable, explosive material (diesel, gasoline , etc) on the machine.

When getting on and off a truck, have a helper give you signal and follow his/her lead.

Refer to chapter A in user's manual regarding the decals on the machine.

▶ CHECKUP LIST FOR OPERATION

Before using the machine, check it and repair if there is a malfunction.

Check engine oil.

- Pull out level gauge, wipe off any fuel leak, put it back in, and pull it out again to see if the oil level is between 「upper limit」 and 「lower limit」 .

Before any operation, check for any foreign materials caught on the engine, muffler, battery, and the fuel tank. Remove them immediately.

Covers that are removed during the maintenance work should be reinstalled to their original positions.

- Attach the cover correctly and firmly.

▶ CAUTIONS DURING THE WORK

Do not load anything that can interfere driving.

- Always keep the driver's seat clean.

Always buckle up when driving.

Opening radiator cap when heated can spring out the steam to have the operator burned.

Open the cap after it is sufficiently cooled down.

Do not drive with depressing the differential gear pedal.

Prohibit anyone to get on the machine.

- Prohibit anyone to get on the machine other than the designated place.
- Even though there are some designated place, do not let people more than capacity get on the machine.



- Never let any passenger mount on the machine.
Also, do not put any object on the machine.
Keep people away from the machine.
- Do not jump on/off the operating machine except for emergency.

Be cautious not to let anyone touch the belt .

Always check the connected area of belt. When two people are working collaboratively, exchange signals each other.

Prevent injury.

- Do not touch power transmission gear, rotating unit, and other dangerous parts.
- Pay special attention if you are working with the machine with blade or sharp projection.
- Be careful not to injure from the work where soils and stones are scattered around.

Safety in inspection, adjustment, etc.

- Make sure to stop the motor and carry out the work in a safe environment.
- When leaving the machine for a break, or other reason, leave the machine in a safe place and descend the working unit to keep them in a safe stopped state.

Removing and installing should be carried out in a safe place and with a safe method.

Do neither stay nor insert foot under the working units.

► CAUTIONS WHEN DRIVING ON FARM ROAD

Driving on roads

- Drive safely observing the relevant regulation.
- Drive at safe speed.
- Be careful not to disturb other drivers.
- When driving a machine with sharp blade or bump, put on a warning sign or detach in advance to prevent any injury.
- Do not drive fast particularly on winding roads with projecting rocks.
- When driving at night, do not detach lighting device. (headlight, turn indicator, work light, brake light, etc.)
- Do not drive fast, abrupt starting, abrupt acceleration, sudden stop, and quick turning.
- When driving at high speed, do not slam on the brake. Never slam on the brake especially when turning at high speed.

When getting off the cab, turn off the engine, lock the parking brake and remove the ignition key.

When loading/unloading the machine

- Choose a place with a leveled and safe ground.
- Drive at low speed.
- Use a ramp with anti-slippery.

When entering paved road

- Use a ramp to cross a ditch or a bank.
- Make sure to use a ramp to enter/exit a high footpath. Be careful with fall and not to overturn.
- Check the safety around the surrounding before starting to drive.

When driving on a slope

- Drive at the minimum speed, lower the operating machine as low as possible and low the center position.

► INSTRUCTION AFTER USE

When the work is completed, stop the engine on a leveled ground, check the machine to clean. (remove any foreign materials)

- Remove straws, dirt, etc. and clean around the engine, silencer, and fuel tank.

Lay a cover on the transplanter (equipment) after the muffler and engine cool down.

Get a regular inspection after the season is over.

- When discarding a part (battery, oil, etc.) or scrap a machine, consult to a dealer and proceed accordingly.

For long-term storage, remove the battery from the machine and store it or disconnect the negative battery cable.

► CAUTIONS FOR INSPECTION & MAINTENANCE

Do not refuel either when the engine is still hot or while driving.

Measures against a fire: Every working place with a risk of fire should be provided with a fire extinguisher. Prevent a fire by taking measures such as making a smoking area.

Always wipe off the leaked fuel.

Be seated in the cab when starting the engine.

After refueling, tighten the fuel cap and check if there is any fuel leakage from tank or pipe.

When opening a cap to supply water to radiator, be careful because steam or boiling water may spray due to overheating.



When getting off the cab, turn off the engine, lock the parking brake and remove the ignition key.

If it is inevitable to park on a slope, choke the wheels.

Park on a leveled and safe ground safely.

Check if the wiring code is in contact with other parts, peeled, loose or having spacing.

Manage PTO

- Stop PTO before stopping the engine.
- Do not remove the PTO protective cover or protective panel for operating machine.
- Do not use PTO adaptor in order to extend the PTO coupler or universal joint to outside of PTO protective cover.

To repair, secure the wheel width, or changing the wheel under either tractor or trailer, with the tractor or trailer raised, choke the wheels that are on the ground.

Do not use hydraulic jack for operating machine or tractor. Instead, use block or stand.

Safety frame

- Do neither weld nor drill a hole on the attached safety frame. Also do not modify it.
- Replace the damaged safety frame with a new one.

- If the safety frame was removed for specialized work, restore it immediately.

Be careful to touch dangerous area such as power transmission gear, rotating unit, etc. Put on a protective cover.

Do neither modify nor remove the safety device.

When checking and replacing the blade to plow the ground

- Stop the engine.
- Prevent the rotary from falling by turning the fall adjusting handle to stop hydraulic pressure.
- Apply the parking brake.
- Do not stand between tractor and rotary.

When working with rotary

- Do not put your hands near the rotating part such as blade axle and universal joint.

- Do not ride on the rotary.
- When driving backward or turning quickly with the rotary raised up, make sure to check behind the machine.
- Adjust the rear cover.

► OTHER PRECAUTIONS

The following items can affect the tractor performance and safety.

Therefore, Repair of these items should be done by your workshop.

- Injection pump, nozzle, engine valve clearance, hydraulic valve, hydraulic pump and evaporator.



H. APPENDIX

1. SPECIFICATIONS H – 2
2. MASS AND TIRE H – 4
3. NOISE LEVEL H – 5
4. VIBRATION REFERRED TO THE OPERATOR
POSITION H – 6
5. LAMPS AND FUSE BOX H – 7
6. ENGINE EMISSION WARRANTY H – 8

1. SPECIFICATIONS

ITEM		T255NH	
ENGINE	MANUFACTURE		YANMAR
	MODEL		3TNV76-UDKTF
	TYPE		WATER COOLED, 4 CYCLE DIESEL
	POWER		18.9kW (25.3HP) @ 3,000RPM
	RATED ENGINE SPEED	RPM	3,000 (HIGH: 3,210±25, LOW: 1,000±25)
	NUMBER OF CYLINDERS		3
	DISPLACEMENT		1,116cc
	BORE AND STROKE		76mm x 82mm
	COMPRESSION RATION		23.15: 1
	INJECTION PUMP		IN-LINE (YANMAR ML)
	LUBRICATION TYPE		FORECED CIRCULATION
ELECTRICAL	BATTERY		12V 50AH (IN 20H)
	ALTERNATOR		12V 40A
POWER TRAIN	CLUTCH		HYDRAULIC & MECHANICAL, HIGH AND LOW WITH CONSTANT-MESH
	NUMBER OF SPEED STEP		HST, 2 FORWARD / 2 REVERSE SPEEDS
	MFWD (4WD)		STANDARD
	BRAKES		WET DISC
	STEERING		HYDROSTATIC
PTO	TYPE		INDEPENDENT
	CONTROL		ELECTRIC / HYDRO
	SPEED	RPM	REAR: 540, MID: 2,000
	SHAFT DIAMETER	in. (mm)	1 $\frac{3}{8}$ (35)

ITEM			T255NH
HYDRAULIC SYSTEM	PUMP CAPACITY	lpm (ℓ/min)	26.3 LPM (6.95 US GPM)
	MAIN RELIEF PRESSURE	Mpa (PSI)	15.8 (2,291)
	STEERING RELIEF PRESSURE	Mpa (PSI)	10.5 (1,522)
	TPL CATEGORY		CAT. 1 (N)
	LIFT CAPACITY		600kg @ HITCH
	NUMBER OF REMOTE VALVE		OPTION
DIMENSION	OVERALL LENGTH	mm (inch)	2,553 (100.5)
	OVERALL WIDTH	mm (inch)	1,164 (45.8)
	OVERALL HEIGHT	mm (inch)	2,320 (91.3)
	WHEELBASE	mm (inch)	1,460 (57.4)
	MIN. GROUND CLEARANCE	mm (inch)	240 (9.4)
	WEIGHT	kg (lb)	768 (1,693)

2. MASS AND TIRE

NO.	AXLE	TIRE DIMENSION INCLUDING LOAD CAPACITY INDEX AND SPEED CATEGORY SYMBOL	ROLLING RADIUS	TIRE LOAD RATING PER TIRE	MAXIMUM PERMISSIBLE MASS PER AXLE ¹	MAXIMUM PERMISSIBLE MASS OF THE VEHICLE ¹	PERMISSIBLE VERTICAL LOAD ON THE COUPLING POINT ^{1 2 3}	TRACK WIDTH(mm)
1	F	6-12, 4PR 62 A6 R-1	275mm	265kg	530kg	1,400kg	350kg	893
	R	9.5-16, 6PR 96 A6 R-1	383mm	710kg	935kg			924
2	F	20x8-10 4PR 87 A2 R-4	223mm	545kg	665kg			1,038
	R	27x12.5-15, 4PR 110 A2 R-4	320mm	1,060kg	935kg			970

1. According to the tire specification.
2. Load transmitted to the reference centre of the coupling under static conditions, irrespective to the coupling device; if the maximum permissible vertical load on the coupling point depending on the coupling is indicated in this table, expand the table at the right side and indicate the identification of the coupling device in the header of the column; for R- or S- category vehicles this column(s) concerns the rear coupling devices if there is such a device.
3. Value to be provided only if the maximum permissible vertical load on the coupling point is lower than indicated in entries 38.3 and 38.4.

► MAX TRAVELLING SPEED

(Km/h)

SUB SHIFT	AG TIRES	TURF TIRES	INDUSTRIAL TIRES
L	6.8	5.9	5.6
H	16.9	14.7	14.1

※ The specifications are subject to change for improvement without notice.

3. NOISE LEVELS

The tractor is approved in accordance with the applicable EC Directives.

To avoid increased noise levels proceed as follows:

- After maintenance operations or repairs refit all the sound-deadening panels and materials correctly
- Do not make changes to the tractor that may lead to an increase in noise emissions.
- Beware of any anomalous noise or vibration if you notice anomalous noise or vibration, park the tractor in a safe position and perform the stopping procedure. Inform maintenance personnel of the situation. Avoid prolonged operation.

Reference standards for the measurement of noise levels:

- The maximum driver-perceived noise level, with the engine at normal operating temperature and measured in accordance with the test method described in the European Directive 2009/76EC

MODEL	DRIVER-PERCEIVED SOUND LEVEL
T255NHEU	89.0 dB(A)

- The maximum noise level measured with the tractor in motion and the tractor stationary, measured in accordance with the method described in European directive 2009/63/EC.

TYPE	MAXIMUM EXTERNAL NOISE LEVEL WITH TRACTOR MOVING	MAXIMUM EXTERNAL NOISE LEVEL WITH TRACTOR STATIONARY
T255NHEU	77.5 dB(A)	77.5 dB(A)



4. VIBRATION REFERRED TO THE OPERATOR POSITION

The value is referred to the amount of mechanical vibration transmitted by the tractor to WHOLEBODY as defined by UNI ISO2631-1:2008.

Said value must be utilized for assessment of the vibration exposure risk, but it cannot cover all the possible conditions of use of the tractor since it may vary in accordance with parameters that are not always related to the tractor (terrain, implements, etc.) If the risk assessment cannot be considered to be exhaustive or if the risk may exceed the values defined in 2002/44/EC, the use of a vibration mater s prescribed.

In order to minimize the vibration transmitted to the whole-body the following best practice rules should be observed:

- Use the most suitable implement for the tractor and the task in hand
- Adjust the seat to suit your weight and stature
- Periodically check the condition of the cab suspensions and renew them if damaged
- Check tire inflation pressure
- Use front axle suspensions, if fitted
- During transfers, adjust tractor speed in order to minimize the vibration level.

The seat vibration values, as obtained from the seat approval in compliance with 78 /764/EEC (amended by 1999/57/EC) are shown in the following table.

Technical data:

Input vibration : Category A, Class I ,II and III

Ambient temperature : 23°C

SEAT	DRIVER TYPE	CORRECTED VIBRATION LEVEL ON SEAT
W15SSS	LIGHT DRIVER (59kg)	1.24m/sec ²
	HEAVY DRIVER (98kg)	1.12m/sec ²

5. LAMPS AND FUSE

▶ LAMPS

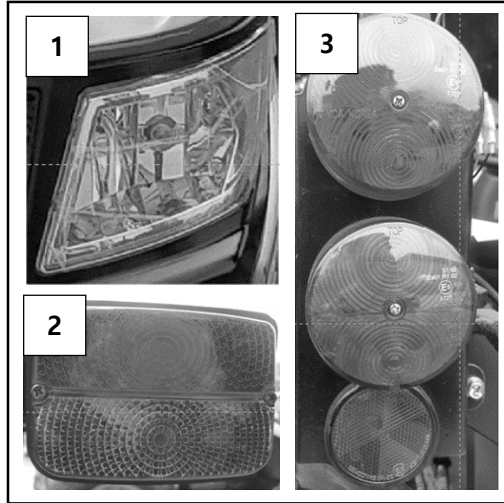

NO	LAMP	SPEC
1	DIPPED BEAM HEAD LAMP	12V 35W
2	FRONT POSITION & DIRECTION INDICATOR	12V 21W / 5W
3	REAR POSITION & DIRECTION INDICATOR	12V 21W / 10W

▶ FUSE BOX

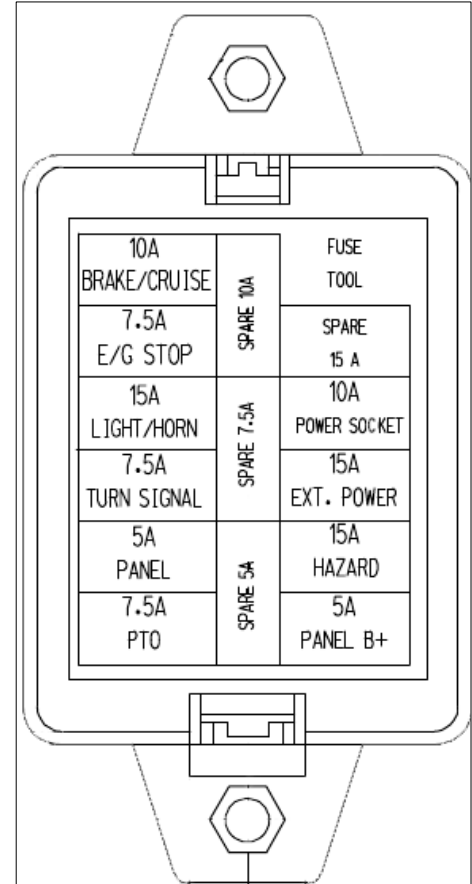

H

6. ENGINE EMISSION WARRANTY

► YOUR WARRANTY RIGHT AND OBLIGATIONS

The California Air Resources Board (CARB), the United State Environmental Protection Agency (EPA) and YANMAR POWER TECHNOLOGY CO., LTD. hereafter referred to as YANMAR, are pleased to explain the emission control system warranty on your 2020, 2021, or 2022 model year industrial compression-ignition engine. California-certified, new non-road (off-road) compression-ignition engines must be designed, built and equipped to meet the State's stringent anti-smog standards. In the remaining forty nine (49) states, new non-road (off-road) compression-ignition engines must be designed, built and equipped to meet the United States EPA emissions standards.

YANMAR must warrant the emission control system on your engine for the periods of time listed below provided there has been no abuse, neglect or improper maintenance of your engine.

Your emission control system may include parts such as the fuel injection system, the air induction system, the electronic control system, EGR (Exhaust Gas Recirculation) system and the exhaust gas after treatment (diesel particulate filter system, urea SCR system). Also included may be hoses, belts, connectors and other emission-related assemblies.

Where a warrantable condition exists, YANMAR will repair your non-road (off-road) compression-ignition engine at no charge to you including diagnosis, parts and labor.

► **MANUFACTURER’S WARRANTY PERIOD**

EPA and ARB certified and labeled non-road (off-road) compression-ignition engines are warranted for the period shown below.

If any emission-related part on your engine is found to be defective during the applicable warranty period, the part will be repaired or replaced by YANMAR.

If your engine is certified as	And its maximum Power is	And its rated speed is	Then its warranty period is
Variable speed or Constant speed	kW<19	Any speed	2,000 hours or two (2) years whichever comes first. In the absence of a device to measure the hours of use, The engine has a warranty period of two(2) years.
Constant speed	19 ≤ kW < 37	3,000rpm or higher	2,000 hours or two (2) years whichever comes first. In the absence of a device to measure the hours of use, The engine has a warranty period of two(2) years
Constant speed	19 ≤ kW < 37	Less than 3,000rpm	3,000 hours of five (5) years whichever comes first. In the absence of a device to measure the hours of use, the Engine has a warranty period of five(5) years.
Variable speed	19 ≤ kW < 37	Any speed	3,000 hours or five (5) years whichever comes first. In the absence of a device to measure the hours of use, the engine has a warranty period of five (5) years
Variable speed or Constant speed	kW ≥ 37	Any speed	3,000 hours or (5) years whichever comes first. In the absence of a device to measure the hours of use, The engine has a warranty period of five (5) years.



► WARRANTY COVERAGE

This warranty is transferable to each subsequent purchaser for the duration of the warranty period. YANMAR recommends that repair or replacement of any warranted part will be performed at an authorized YANMAR dealer.

Warranted parts not scheduled for replacement as required maintenance in the owner's manual shall be warranted for the warranty period. Warranted parts scheduled for replacement as required maintenance in the owner's manual are warranted for the period of time prior to the first scheduled replacement.

Any warranted parts scheduled for replacement as required maintenance that are repaired or replaced under warranty shall be warranted for the remaining period of time prior to the first scheduled replacement. Any part not scheduled for replacement that is repaired or replaced under

warranty shall be warranted for the remaining warranty period.

During the warranty period, YANMAR is liable for damages to other engine components caused by the failure of any warranted part during the warranty period.

Any replacement part which is functionally identical to the original equipment part in all respects may be used in the maintenance or repair of your engine, and shall not reduce YANMAR's warranty obligations.

Add-on or modified parts that are not exempted may not be used. The use of any non-exempted add-on or modified parts shall be grounds for disallowing a warranty.

► WARRANTED PARTS

This warranty covers engine components that are a part of the emission control system of the engine as delivered by YANMAR to the original retail purchaser. Such components may include the following:

- (A) Fuel injection system (including Altitude compensation system)
- (B) Cold start enrichment system
- (C) Intake manifold and Air intake throttle valve
- (D) Turbocharger systems
- (E) Exhaust manifold and exhaust throttle valve
- (F) Positive crankcase ventilation system
- (G) Charge Air Cooling systems
- (H) Exhaust Gas Recirculation (EGR) systems
- (I) Exhaust gas after treatment (Diesel Particulate Filter (DPF) system)
- (J) Electronic Control units, sensors, solenoids and wiring harnesses used in above systems
- (K) Hoses, belts, connectors and

assemblies used in above systems
(L) Emission Control Information
Labels

Since emissions related parts may vary slightly between models, certain models may not contain all of these parts and other models may contain the functional equivalents.

► EXCLUSION

Failures other than those arising from defects in material or workmanship are not covered by this warranty.

The warranty does not extend to the following: malfunctions caused by abuse, misuse, improper adjustment, modification, alteration, tampering, disconnection, improper or inadequate maintenance, or use of non-recommended fuels and lubricating oils; accident-caused damage and replacement of expendable items made in connection with scheduled maintenance.

YANMAR disclaims any responsibility for incidental or consequential such as loss of time, inconvenience, loss of use of equipment/engine or commercial loss.

► OWNER'S WARRANTY RESPONSIBILITIES

As the engine owner, you are responsible for carrying out the required maintenance listed in this operation manual.

YANMAR recommends that you retain all documentation, including receipts, covering maintenance on your non-road (off-road) compression-ignition engine, but YANMAR cannot deny warranty solely for the lack of receipts, or for your failure to ensure the performance of all scheduled maintenance.

YANMAR may deny your warranty coverage if your non-road (off-road) compression-ignition engine or a part has failed due to abuse, neglect, improper maintenance or unapproved modifications.

Your engine is designed to operate on diesel fuel only. Use of any other fuel may result in your engine no longer operating in compliance with CARB and EPA emissions requirements.

You are responsible for initiating the warranty process. You are responsible for presenting your engine to an authorized YANMAR dealer or distributor as soon as a problem exists. The warranty repairs should be completed by the dealer as expeditiously as possible.

If you have any questions regarding your warranty rights and responsibilities, or would like information on the nearest YANMAR dealer or authorized service center, you should contact YANMAR America Corporation.

Website: <https://www.yanmar.com>

E-mail: CS_support@yanmar.com

Toll free telephone number: 1-800-872-2867, 1-855-416-7091

► WHAT THE EMERGENCY STATIONARY TYPE ENGINE OWNER MUST DO

The engines for emergency stationary type generators certified by Federal Law (40 CFR Part60) are limited to emergency use only, and the operation for maintenance checks and verification test for functions is required.

The total operating hours for maintenance and verification test for functions should not exceed 100 hours per year.

However, there is no limitation on the operating hours for emergency use. Keep a log of the number of hours the engine is operated for both emergency use and non-emergency use.

Also, note the reason for the operation.



I. INDEX

1. INDEX | - 2

• 0~9

4WD LEVER C-13

• A

ABOUT THIS MANUAL A-6

ADJUSTING THROTTLE LEVER, TOE-IN E-12

ADJUSTMENT OF CHECK LINK C-17

ADJUSTMENT OF LIFT ROD C-17

ADJUSTMENT OF TOP LINK C-17

ADJUSTMENT OF YOKE ROD ON LOWER LINK C-18

AIR CLEANER CLEANING E-9

AIR CLEANER DUST VALVE E-9

AIR CLEANING SYSTEM D-18

ALWAYS USE SAFETY LIGHTS AND DEVICES B-5

ANTI-FREEZE E-5

APPENDIX H-1

AVOID HIGH PRESSURE FLUIDS B-6

• B

BACK SIDE OF THE TRACTOR A-4

BATTERY CHARGING D-12

BATTERY CHECK E-12

BATTERY DISCONNECTING SWITCH E-13

BATTERY DISCONNECTION B-8

BATTERY JUMP START E-13

BATTERY MAINTENANCE E-12

BLEEDING FUEL SYSTEM E-10

BRAKE D-19

BRAKE PEDAL C-11

BRAKE PEDAL FREE PLAY E-11

BRAKE TROUBLESHOOTING F-5

• C

CABIN TYPE A-11

CAUTIONS DURING THE WORK G-3

CAUTIONS FOR DRIVING INTO OR OUT OF FIELD D-6

CAUTIONS FOR DRIVING ON ROAD D-6

CAUTIONS FOR INSPECTION & MAINTENANCE G-5

CAUTIONS WHEN DRIVING ON FARM ROAD G-4

CHANGE ENGINE OIL FILTER E-10

CHARGE LAMP C-9

CHECK DURING DRIVING D-12

CHECKS & SERVICING EACH PART E-5

CHECKS DURING DRIVING D-12

CHECKUP LIST FOR OPERATION G-3

CLEANING FUEL FILTER E-9

CLEANING OIL WATER SEPARATOR E-10

CLOSING HOOD E-4

COMBINATION SWITCH C-3

CONNECTION TO IMPLEMENTS D-9

CONTROL INSTRUMENTS C-10

COOLANT CHANGE E-5

COOLANT CHECK	E-5	EXTERIOR VIEW	A-2
COOLANT TEMPERATURE	D-13		
COOLANT TEMPERATURE WARNING LAMP	C-9		
COOLING SYSTEM	D-21		
CRUISE CONTROL LEVER	C-12		
CUSHION STRENGTH ADJUSTMENT	A-12		
• D		• F	
DAILY STORAGE	E-16	FALLING OBJECT PROTECTIVE STRUCTURE (FOPS)	B-13
DAMAGE OF ROPS	A-11	FANBELT ADJUSTMENT	E-11
DESCRIPTION	A-8	FIGURE OF DASHBOARD	C-2
DIFFERENTIAL LOCK PEDAL	C-15	FIGURE OF THREE POINT LINKAGE	C-16
DISCONNECTION FROM IMPLEMENTS	D-9	FRONT AXLE OIL CHANGE	E-8
DON'Ts –FOR SAFE OPERATION	B-23	FRONT AXLE OIL CHECK	E-8
DOs & DON'Ts	B-22	FUEL GAUGE	D-13
DOs –FOR BETTER PERFORMANCE	B-22	FUEL GAUGE & FUEL WARNING LAMP	C-6
		FUSE REPLACING	E-14
• E		• G	
ELECTRIC INSTRUMENTS TROUBLESHOOTING	F-7	GENERAL IMPLEMENT	D-14
EMERGENCY EXITS	B-9	GENERAL INFORMATION	A-1
ENGINE	D-18	GENERAL INFORMATION OF DECALS	B-24
ENGINE IDLING	D-3	GLOW SIGNAL LAMP	C-9
ENGINE OIL CHANGE	E-6	GREASING AND DRAIN POINTS	E-15
ENGINE OIL CHECK	E-6	GREASING BRAKE ARM	E-15
ENGINE TROUBLESHOOTING	F-2	GREASING EACH PART	E-15
ENGINE WARNING LAMP	C-8		
		• H	
		HANDLE FUEL SAFELY TO AVOID FIRE	B-5
		HARNES AND FUSES CHECK	E-14
		HAZARD WARNING SIGNAL SWITCH	C-3

HEADLIGHT LAMP	C-7	LUBRICATING OIL	D-19
HOSES AND CLAMPS	E-11		
HOURLY METER	C-6	• M	
HOW TO START ENGINE	D-2	MAIN FUSES	E-14
HOW TO USE OF THE JACK	D-22	MAINTENANCE	E-1
HYDRAULIC SYSTEM TROUBLESHOOTING	F-6	MAINTENANCE SCHEDULE	E-2
		MASS AND TIRE	H-4
• I		MONITOR PANEL	C-5
IDLING IN COLD WEATHER	D-3	MONITOR PANEL & GAUGES	C-5
IMPLEMENTS	D-9	MOUNTING AND DEMOUNTING IMPLEMENTS	B-17
INDEX	I-2	MOUNTING IMPLEMENTS	D-9
INSTRUCTION AFTER USE	G-5		
INSTRUCTION BEFORE USE	G-2	• N	
INTRODUCTION & DESCRIPTION	A-7	NOISE LEVEL	H-5
• K		• O	
KEEP RIDERS OFF TRACTOR	B-4	OIL PRESSURE	D-12
KEY SWITCH	C-3	OIL PRESSURE WARNING LAMP	C-7
		OIL SYSTEM	D-19
• L		OPENING COVERS	E-4
LAMPS AND FUSE	H-7	OPENING HOOD	E-4
LEFT SIDE OF THE TRACTOR	A-3	OPENING SIDE COVERS	E-4
LOADING TO OR UNLOADING FROM TRUCK	D-6	OPERATING PTO	D-7
LONG-TERM STORAGE	E-16	OPERATING TRACTOR	D-4
LOWERING SPEED CONTROL KNOB FOR THE 3 POINT HITCH	C-15	OPERATION	D-1
		OPERATION OF PTO	D-7

OPERATION TIPS D-18
 OPERATOR PROTECTIVE STRUCTURE (OPS) B-13
 OTHER PRECAUTIONS G-7
 OTHERS D-21
 OWNER ASSISTANCE A-9

• **P**

PARK TRACTOR SAFELY B-4
 PARKING BRAKE LAMP C-8
 PARKING BRAKE LEVER C-11
 PARKING THE TRACTOR D-5
 PERIODICAL CHECK AND SERVICE SCHEDULE TABLE E-2
 POSITION LEVER C-14
 PRACTICE SAFE MAINTENANCE B-6
 PRECAUTION TO AVOID TIPPING B-4
 PRECAUTIONS FOR HANDLING IMPLEMENTS D-14
 PREVENT ACID BURNS B-7
 PREVENT BATTERY EXPLOSION B-7
 PRINCIPLE OF AUTO PREHEATING SYSTEM D-2
 PROTECT CHILDREN B-3
 PTO INTENTION SWITCH C-4
 PTO LAMP C-8, D-7
 PTO LEVER C-13
 PTO ROTATION TABLE D-8
 PTO SHAFT CAP C-18
 PTO SWITCH C-4

• **R**

READ SAFETY INSTRUCTION B-2
 RIGHT SIDE OF THE TRACTOR A-2
 ROPS A-10
 ROPS (ROLL OVER PROTECTIVE STRUCTURE) A-10
 ROPS TYPE A-11

• **S**

SAFE OPERATION OF YOUR TRACTOR B-15
 SAFETY DECALS B-24
 SAFETY DECALS ON CHASSIS B-25
 SAFETY INSTRUCTIONS B-2
 SAFETY MARK G-2
 SAFETY PRECAUTIONS WHEN USING LOADER B-10
 SAFETY PRECAUTIONS B-1
 SAFETY START B-9
 SAFETY TIPS DURING MAINTENANCE B-16
 SEAT ADJUSTMENT A-12
 SEAT SLIDING A-12
 SERVICE & PARTS A-5
 SERVICE TRACTOR SAFELY B-8
 SHIFTING AND DRIVING D-4
 SIGNAL SIGNS B-2
 SPECIFICATIONS H-2
 SPEED CONTROL PEDALS C-11
 STANDARD FOR FARMWORK G-1

START & STOP OF ENGINE	D-2	TRANSMISSION OIL CHANGE	E-7
START ON STEEP SLOPE	D-5	TRANSMISSION OIL CHECK	E-7
STARTING OFF	D-4	TRANSPORT TRACTOR BY TRUCK	B-12
STAY CLEAR OF ROTATING SHAFTS	B-5	TROUBLESHOOTING	F-1
STEERING WHEEL TROUBLESHOOTING	F-6	TURN SIGNAL LAMPS	C-7
STOPPING ENGINE	D-3	TURNING IN FIELD	D-4
STORING THE TRACTOR	E-16	TYPE OR NUMBER OR ENGINE & CHASSIS	A-5
SUB SHIFT LEVER	C-12		
SWITCHES	C-2		
• T		• U	
TACHOMETER	C-6	UNIVERSAL SYMBOLS	B-29
THE FOLLOWING PRECAUTIONS ARE SUGGESTED TO		USAGE AND DISPOSAL	E-17
HELP PREVENT ACCIDENTS	B-18	USE AFTER LONG-TERM STORAGE	E-17
THREE POINT LINKAGE	C-16	USE OF HAZARDOUS SUBSTANCES	B-13
THROTTLE LEVER	C-12	USE OF ROPS AND SEAT BELT	B-3
TIPS FOR DRIVING ON SLOPE	D-5	USE OF TRACTOR WITH ROPS LOWERED CAN CAUSE	
TOWING SAFELY	B-12	FATAL INJURIES	A-10
TOWING THE TRACTOR	D-10		
TOWING WITH ENGINE OFF	D-11	• V	
TOWING WITH ENGINE RUNNING	D-10	VIBRATION REFERRED TO THE OPERATOR POSITION	H-6
TRACTOR CONTROLS	C-10		
TRACTOR IDENTIFICATION	A-5	• W	
TRACTOR INSTRUMENTS	C-1	WARRANTY OF THE PRODUCT	A-5
TRACTOR RUNAWAY	B-9	WINTER OPERATION WITH DIESEL FUEL	D-21
TRAILER HITCH	C-18	WORK IN VENTILATED AREA	B-8
		WORK PROCEDURES	D-14



T255 (NH)

OPERATOR'S MANUAL FOR TYM TRACTORS

⚠ ALL INFORMATION, ILLUSTRATIONS AND SPECIFICATIONS IN THIS MANUAL ARE BASED ON LATEST INFORMATION AVAILABLE AT THE TIME OF PUBLICATION. THE RIGHT IS RESERVED TO MAKE CHANGES AT ANY TIME WITHOUT A NOTICE.

221123

**PART NO.
1432-912-002-1**