

4815H\_US\_FL(AC02166) TRACTOR

## Parts Catalogue



# CONTENTS

GROUP NO	GROUP NAME	PAGE
G. ENGINE		
A01_007	CYLINDER BLOCK	6
A02_005	DRIVE PULLY	8
A03_004	CRANK SHAFT PULLEY	10
A04_005	GLOW PLUG ASS'Y OPTION	12
A05_005	CRANK SHAFT ASS'Y OPTION	14
A06_004	BREATHER OPTION	16
A07_005	CAMSHAFT	18
A08_003	ALTERNATOR	20
A09_003	COOLING WATER PUMP	22
A10_010	COOLING FAN SPACER	24
A11_007	INJECTOR	26
A12_014	FUEL INJECTON	28
A13_005	PLUMBING, FUEL	30
A14_003	FUEL FILTER BRACKET	33
A16_018	FUEL FILTER ASS'Y OPTION	35
A17_014	INTAKE MANIFOLD ASS'Y OPTION	37
A18_011	FLYWHEEL	39
A19_007	FLYWHEEL HOUSING	41
A20_010	HEAD, CYLINDER	43
A21_004	HEAD COVER	45
A23_009	TURBOCHARGER SUPPORT ASS'Y OPTION	47
A25_002	OIL JET ASS'Y OPTION	49
A26_005	COOLER, ENGINE OIL	51
A27_005	OIL PAN ASS'Y OPTION	53
A28_001	PUMP, LUBRICATING OIL	55
A29_005	FILTER, LUBRICATING OIL	57
A30_003	FRONT GEAR ACCESSORY DRIVE	59
A31_007	PISTON	61
A32_003	LEVER, LOCKER	63
A33_013	EXHAUST MANIFOLD	65
A35_002	IDLE GEAR	67
A36_004	COVER, FRONT GEAR	69
A37_001	BALANCE ASS'Y	71
A38_009	GAUGE, OIL LEVEL	73

# CONTENTS

GROUP NO	GROUP NAME	PAGE
<b>G. ENGINE</b>		
A39_001	OIL FILLER CAP	75
A40_003	LIFT ASS'Y OPTION	77
A42_003	MOTER, STARTIONS	79
A43_001	DPF SUPPORT OPTION	81
A44_006	DPF MOUNTING OPTION	83
A45_011	DPF	85
A48_006	V-BELT	87
<b>B. ENGINE ACCESSORIES</b>		
B01010	FUEL TANK	89
B02020	RADIATOR	91
B03010	AIR CLEANER	93
B05011	LEVER ACCELERATOR	95
<b>C. CLUTCH, BREAK, LEVER</b>		
C02010	BRAKE PEDAL	97
C02050	PARKING BRAKE	99
C03010	HYD SHIFT TRANSMISSION PEDAL	101
<b>D. HYDRAULIC</b>		
D01010-B	HYD PUMP	103
D01020-B	LOW PRESSURE PIPE	105
D01040	HYD FILTER	107
D02010	STEERING COLUMN	109
D02030	P.S.T HOSE	111
D02040	P.S.T CYLINDER	113
D03010	OIL COOLER	115
<b>E. FRONT AXLE</b>		
E01010	FRONT AXLE CASE	117
E01013	SPACER	119
E01030	GEAR CASE, FRONT AXLE	121
E01070	FRONT DRIVE SHAFT	123
E01080	TIE ROD	125
<b>F. TRANSMISSION</b>		
F01010-B	CLUTCH HOUSING	127
F01020	TRANSMISSION CASE	129
F01030	REAR AXLE HOUSING	131

# CONTENTS

GROUP NO	GROUP NAME	PAGE
<b>F. TRANSMISSION</b>		
F01050	HYD SHIFT TRANSMISSION HOUSING	133
F03040	RANGE SHIFT DRIVE SHAFT	135
F04010	FRONT DRIVE SHAFT	137
F05020	RING GEAR&DIFF.GEAR ASS'Y	139
F05020	RING GEAR&DIFF.GEAR ASS'Y	141
F06030	BRAKE	143
F07030	PTO DRIVE SHAFT	145
F07070	MAIN P.T.O SHAFT	147
F08060	FORK, PTO SHIFT	149
F10010	CASE, HYD CYLINDER	151
F10020	LIFT ARM	153
F10030	SAFETY VALVE	155
F10031	RELIEF VALVE	157
F10040	STOP VALVE	159
F10061	DRAFT/POSITION CONTROL LEVER	161
F10063	DRAFT CONTROL LEVER	163
F10064	POSITION CONTROL LEVER	165
F11020	LEVER ASS'Y, RANGE SHIFT	167
F11060	DIFF. LOCK PEDAL	169
F11080	4WD LEVER	171
<b>G. SHEET METAL, CABIN</b>		
G01020	BONNET	173
G01040	LOCKING ASS'Y, BONNET	175
G01060-B	BONNET SUPPORT	177
G01062	FIXED BRACKET, BONNET	179
G01080	FRONT AXLE BRACKET	181
G04060	FOOT REST ASS'Y	183
G04070	SEAT	185
G04090	FENDER	187
G04120	ROPS FRAME ASS'Y	189
G05020	TOP LINK	191
G05030	LOWER LINK	193
G05050	LIFT LINK	195
G05070	DRAWBAR HITCH	197

# CONTENTS

GROUP NO	GROUP NAME	PAGE
G. SHEET METAL, CABIN		
G05090	SIDE COVER	199
G06010	TOOL BOX & CUP HOLDER	201
H. ELECTRICALS, HARNESS		
H01030	BATTERY	203
H03000	ELE'C WIRING	205
H04051	SWITCH/DASHBOARD	207
H04070	CONTROLLER	209
I. WEIGHT, TOOLS, TIRE		
I03000	NAME PLATE	211
I06010	SUN VISOR(OPTION)	213

A01\_007

A2300N4-UTR\_4  
(AB00277)

# CYLINDER BLOCK

Year/Month

2022-12-19

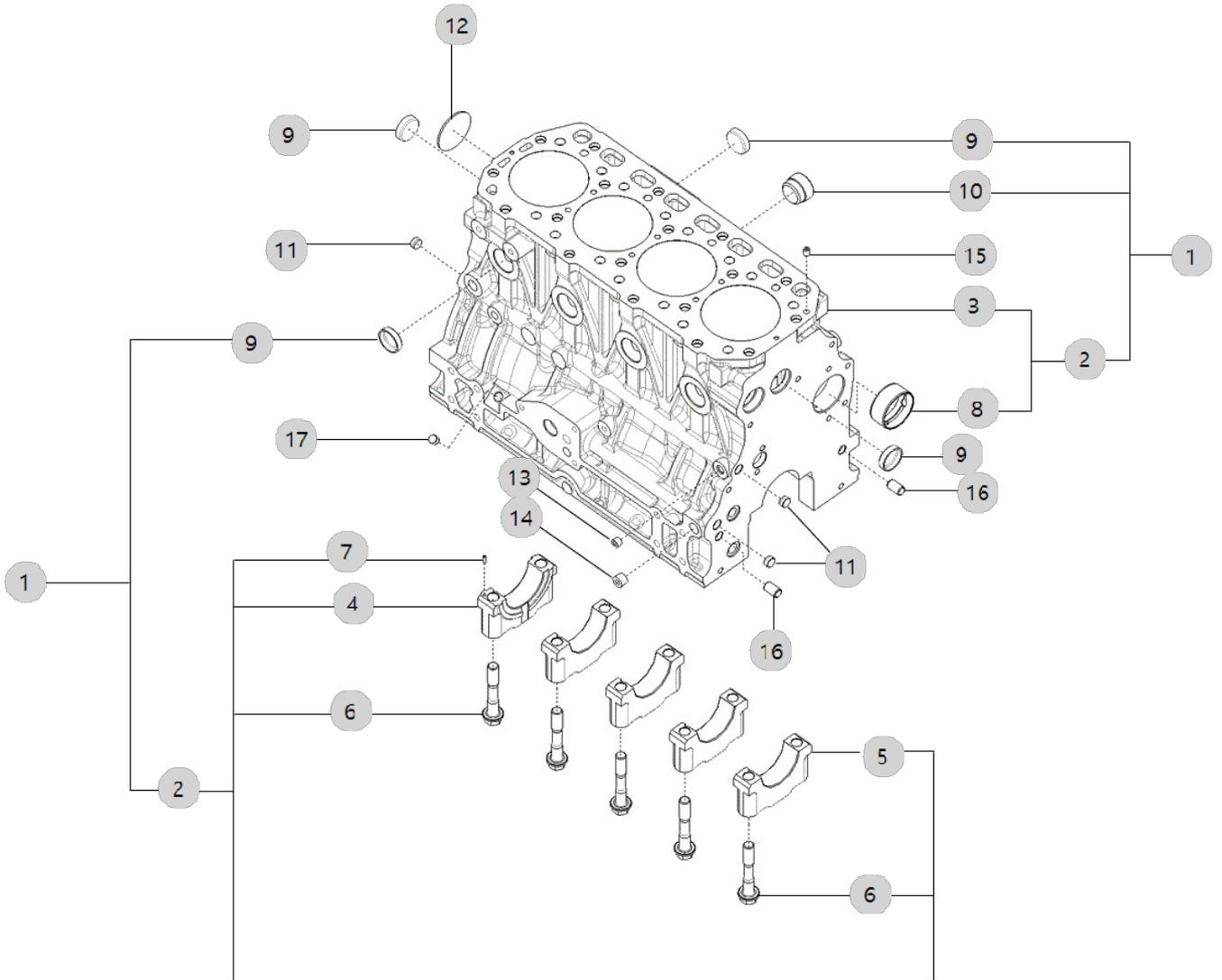



A02\_005

A2300N4-UTR\_4  
(AB00277)

DRIVE PULLEY

Year/Month

2022-12-19

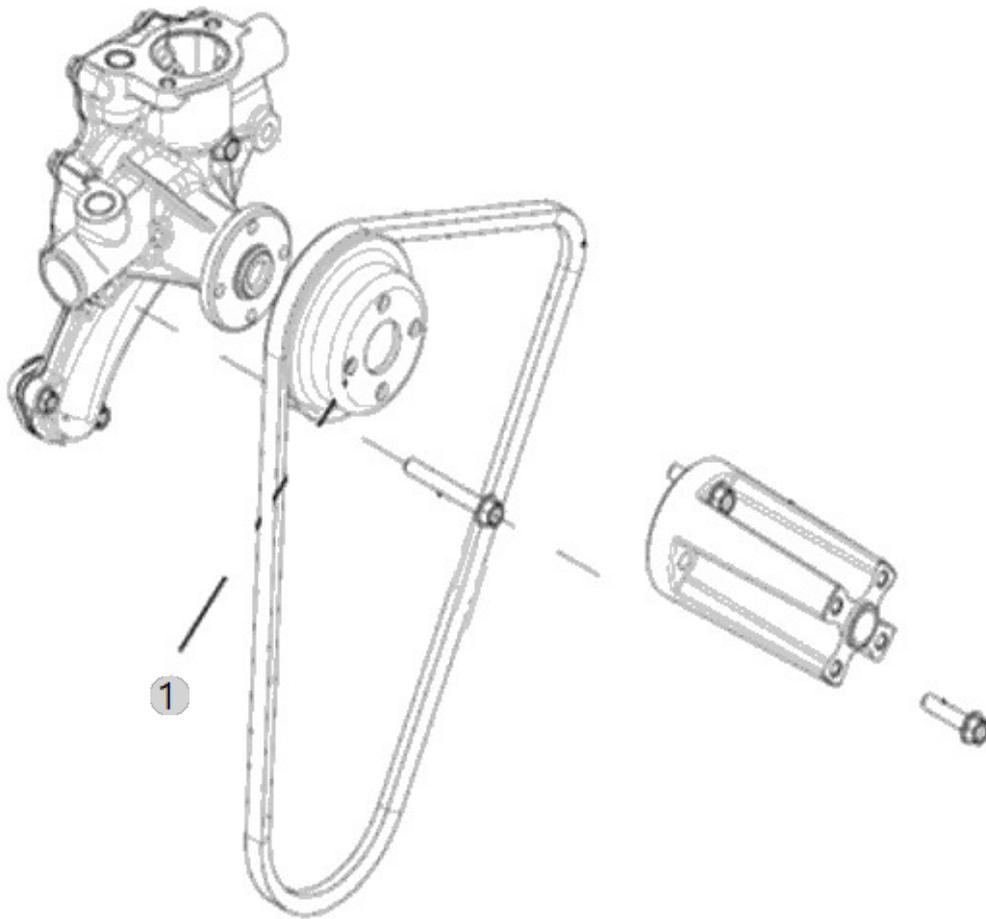





A03\_004

A2300N4-UTR\_4  
(AB00277)

# CRANK SHAFT PULLEY

Year/Month

2022-12-19

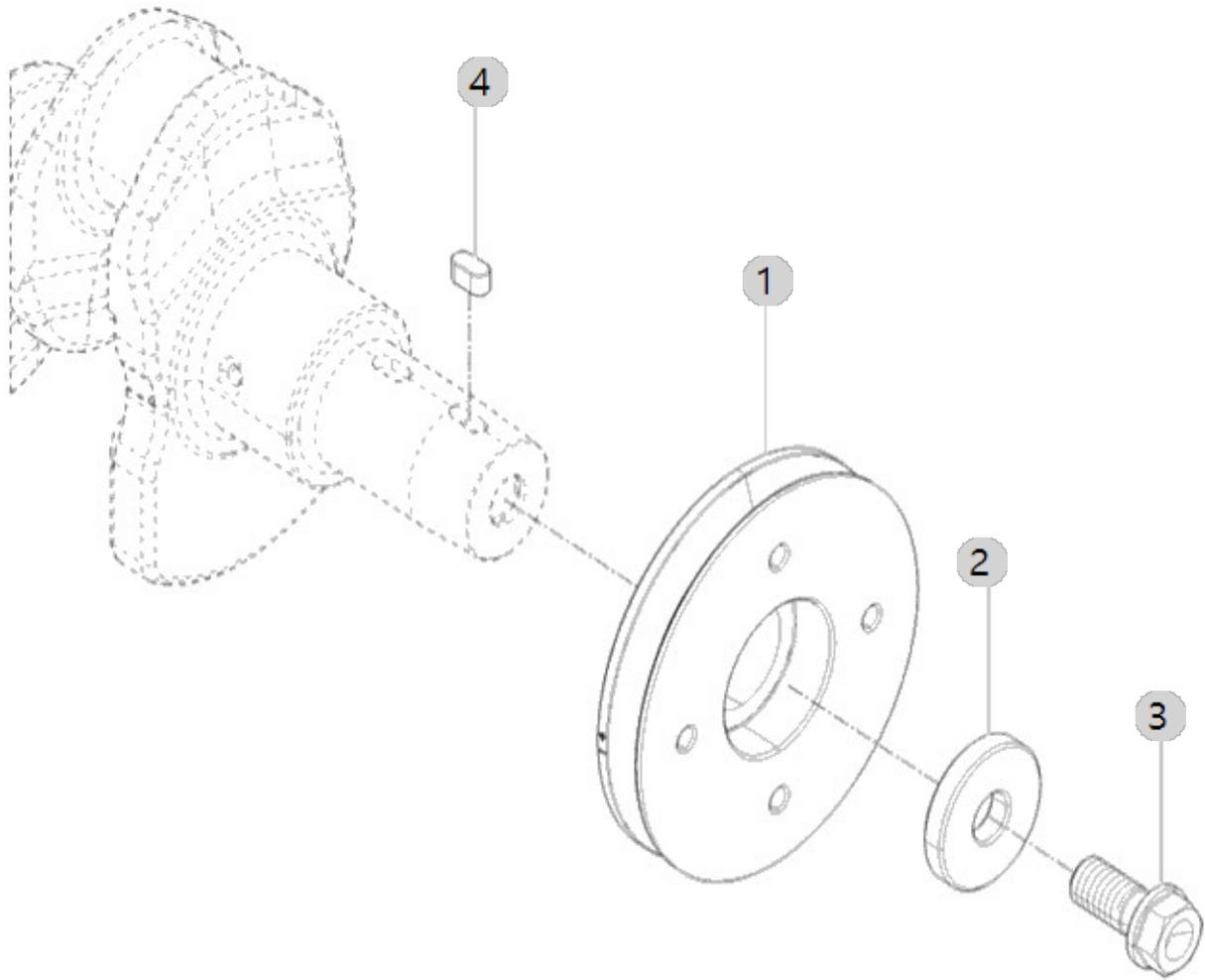



A04\_005

A2300N4-UTR\_4  
(AB00277)

### GLOW PLUG ASS'Y OPTION

Year/Month

2022-12-19

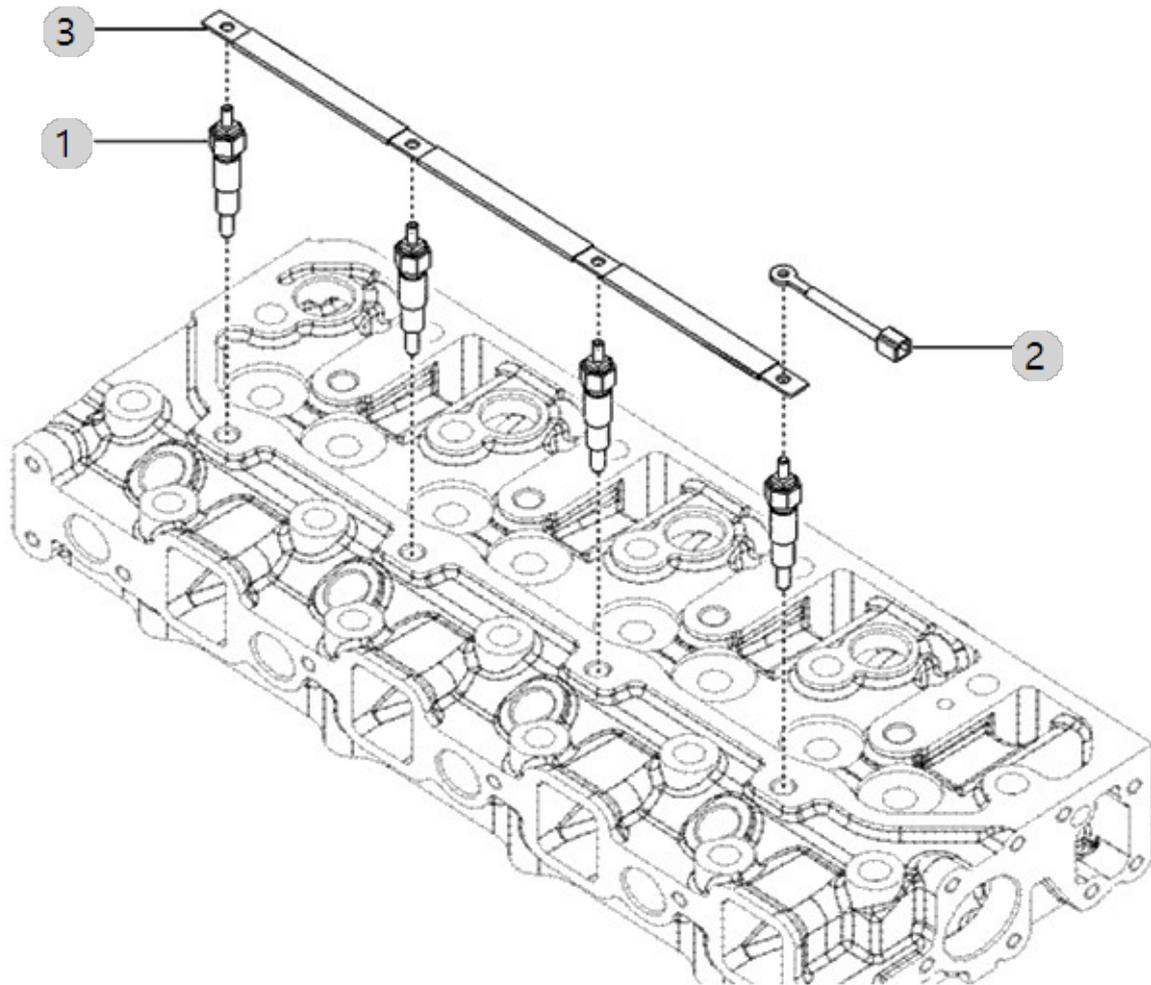



A05\_005

A2300N4-UTR\_4  
(AB00277)

### CRANK SHAFT ASS'Y OPTION

Year/Month

2022-12-19

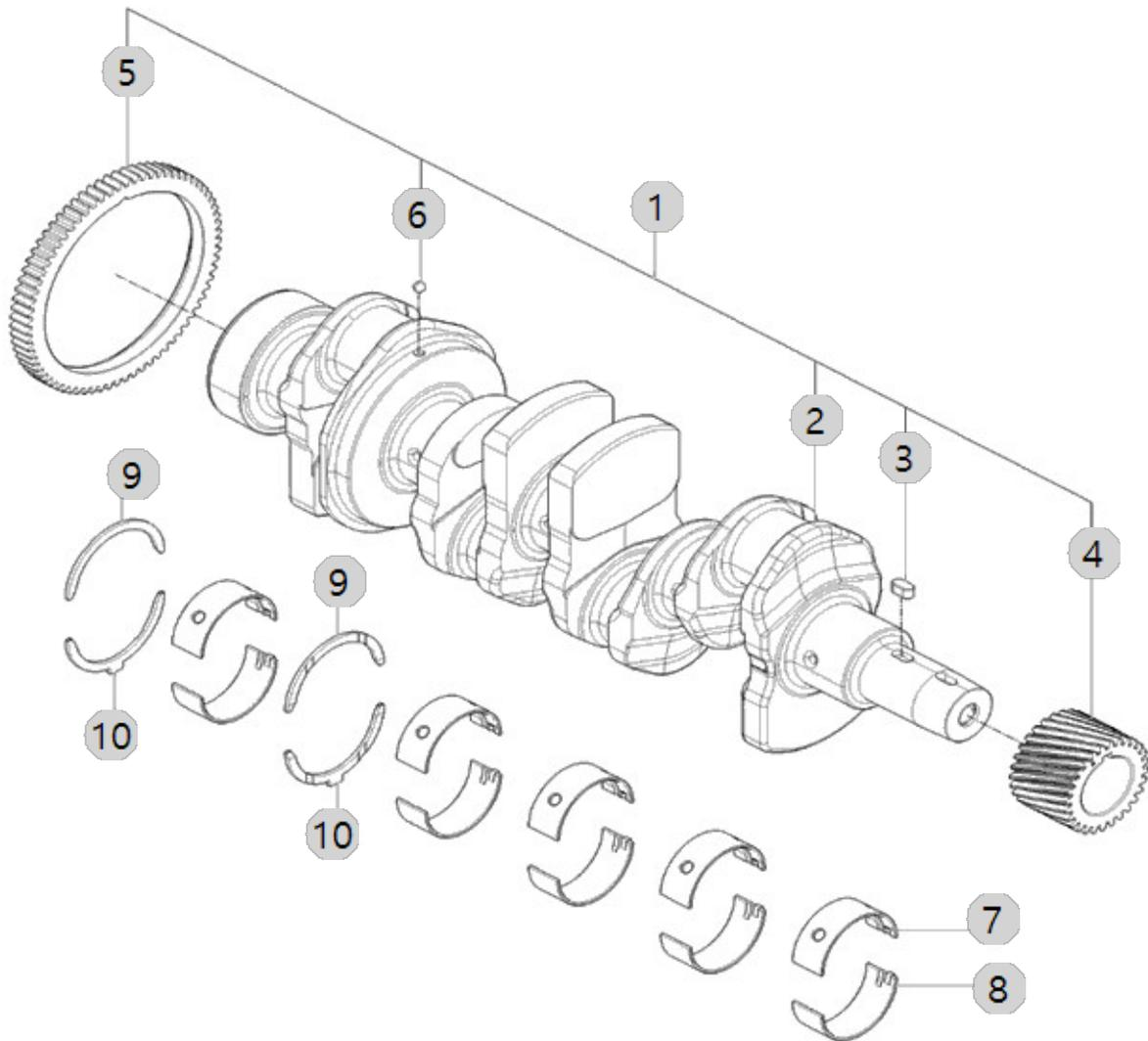



A06\_004

A2300N4-UTR\_4  
(AB00277)

BREATHER OPTION

Year/Month

2022-12-19

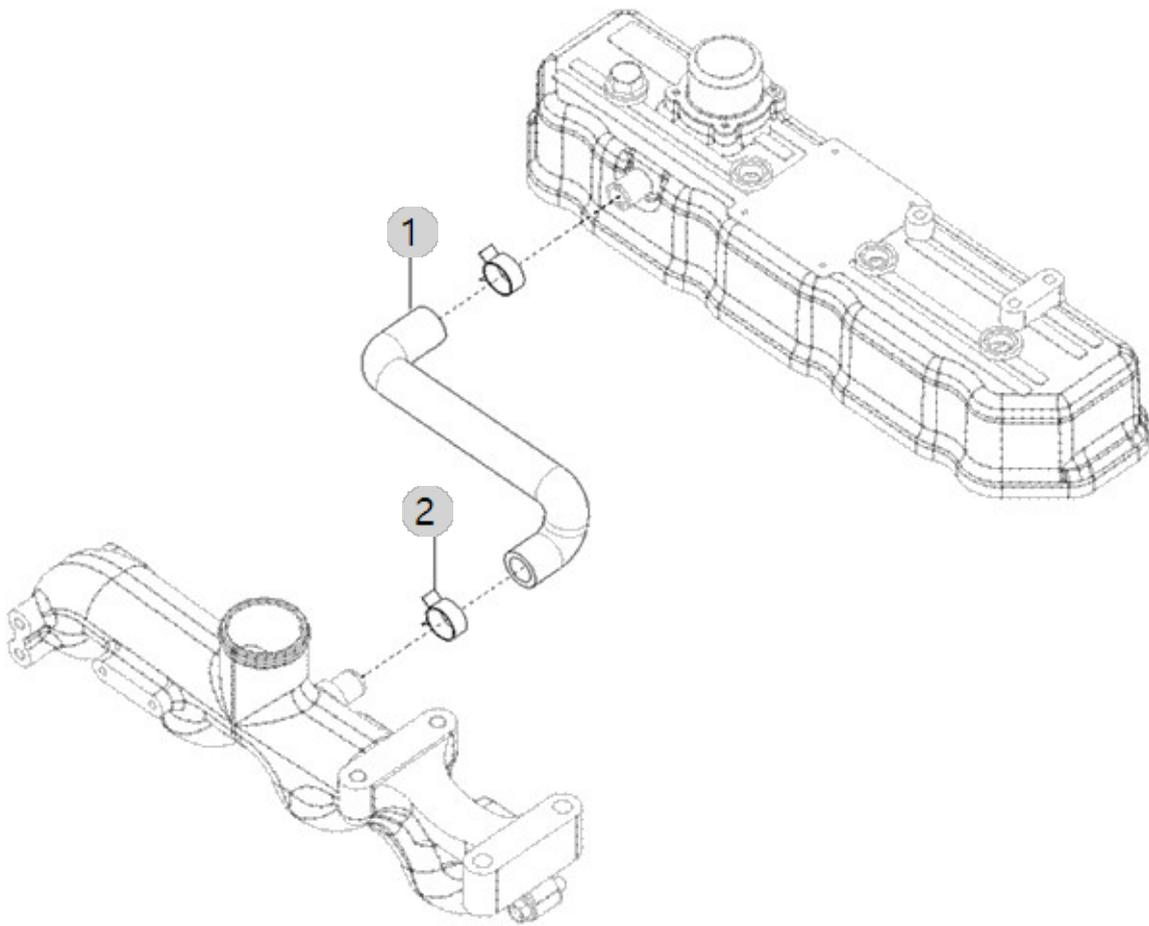









A08\_003

A2300N4-UTR\_4  
(AB00277)

# ALTERNATOR

Year/Month

2022-12-19

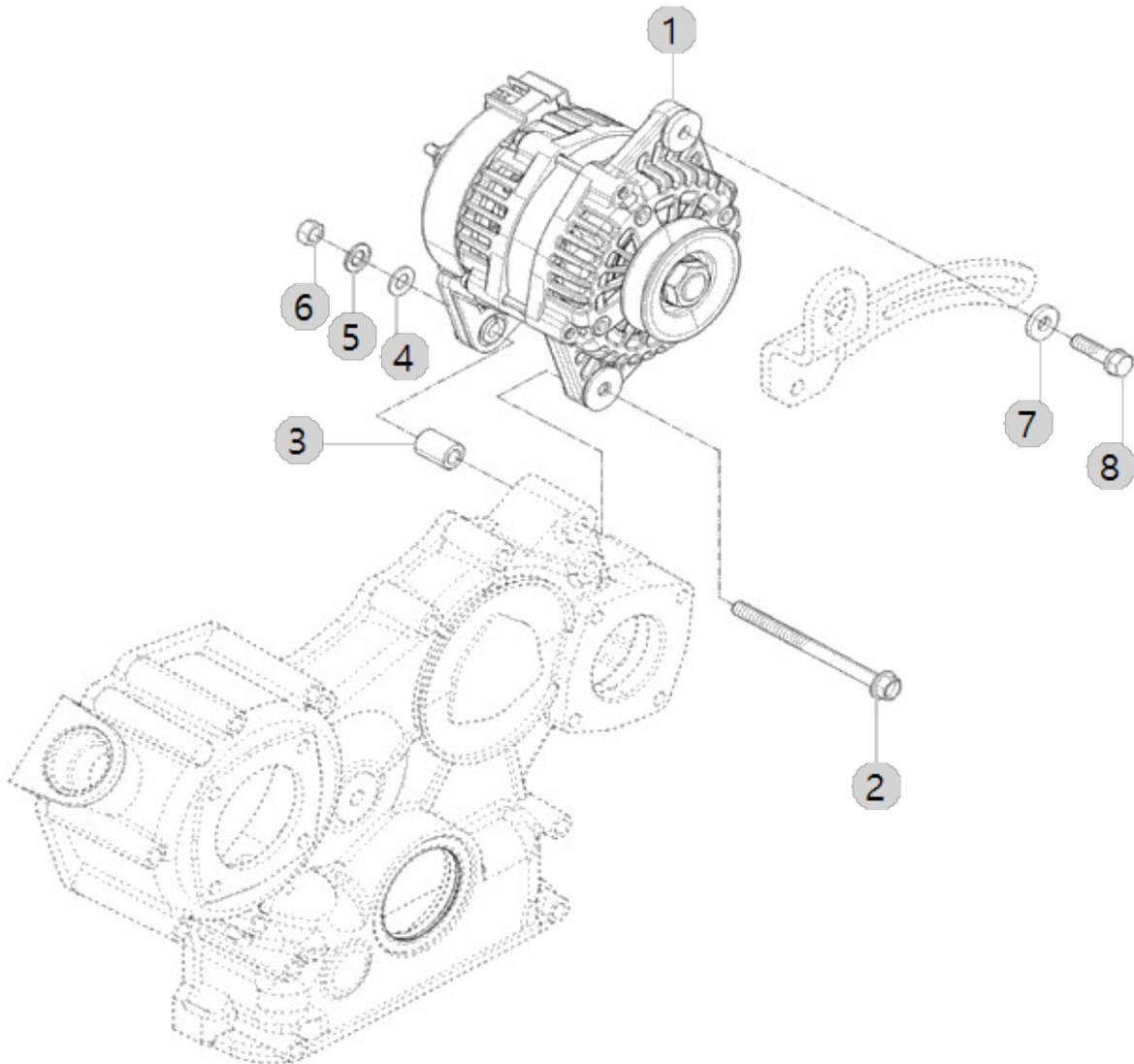



A09\_003

A2300N4-UTR\_4  
(AB00277)

### COOLING WATER PUMP

Year/Month

2022-12-19

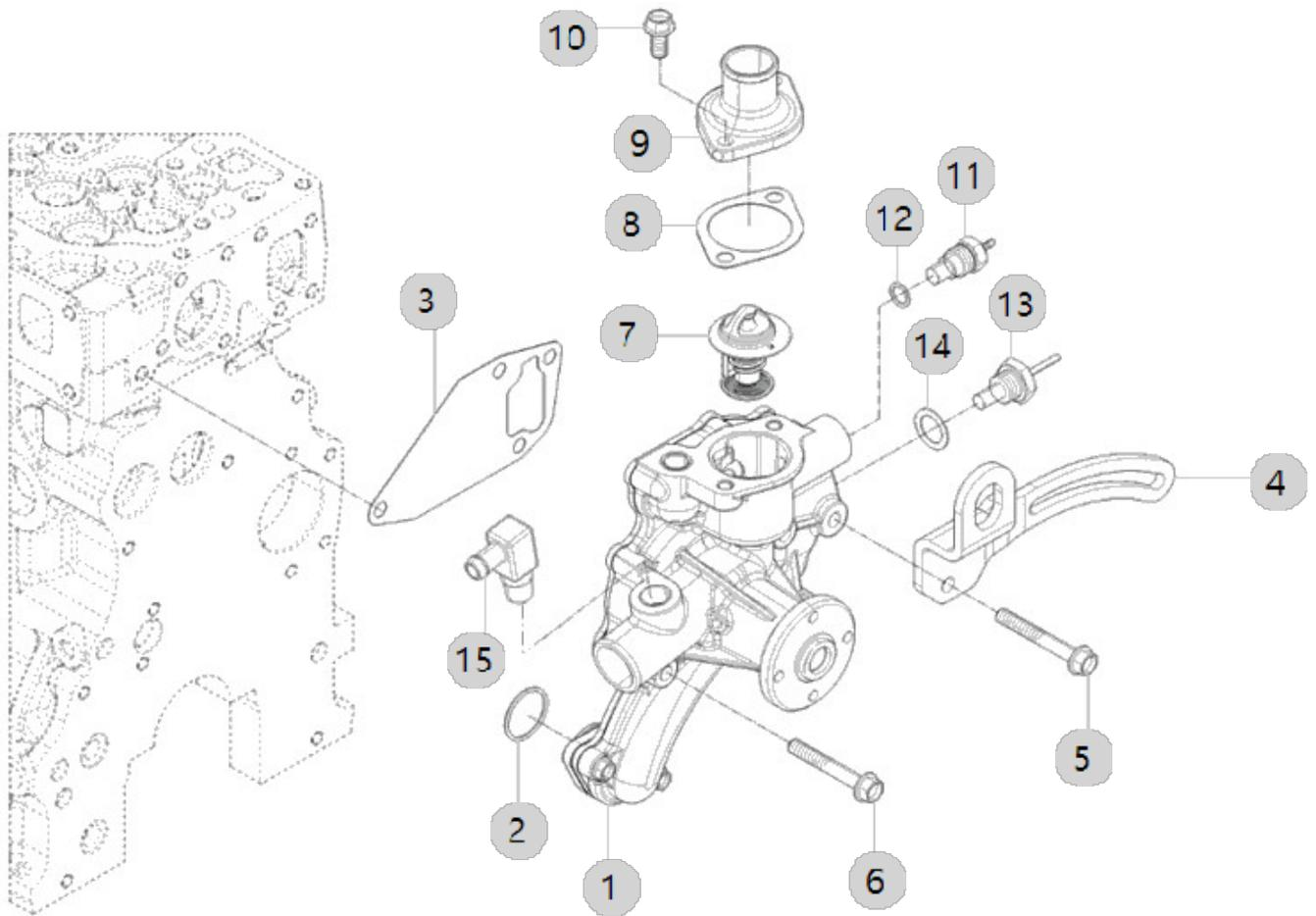



A10\_010

A2300N4-UTR\_4  
(AB00277)

COOLING FAN SPACER

Year/Month

2022-12-19

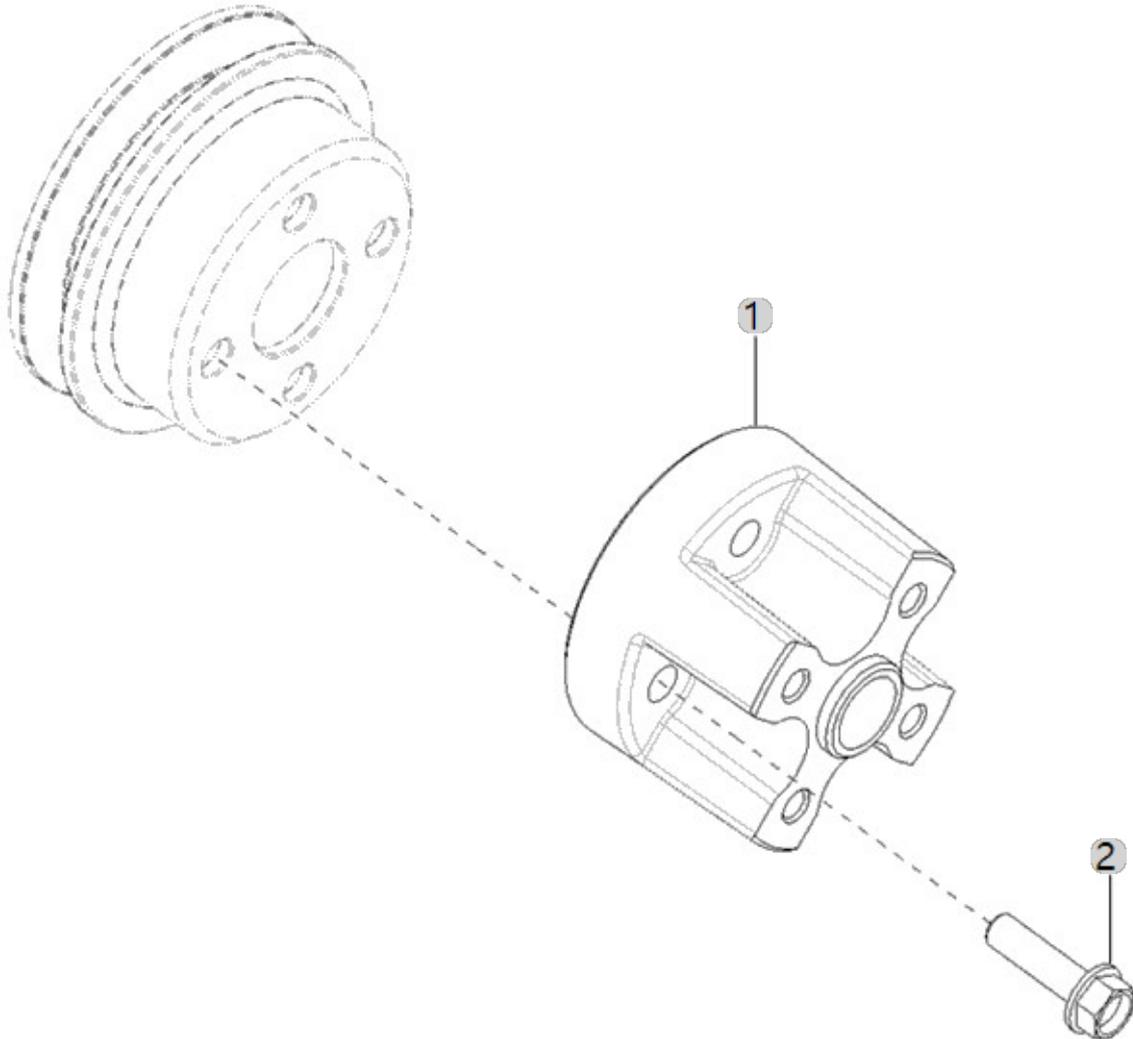





A11\_007

A2300N4-UTR\_4  
(AB00277)

# INJECTOR

Year/Month

2022-12-19

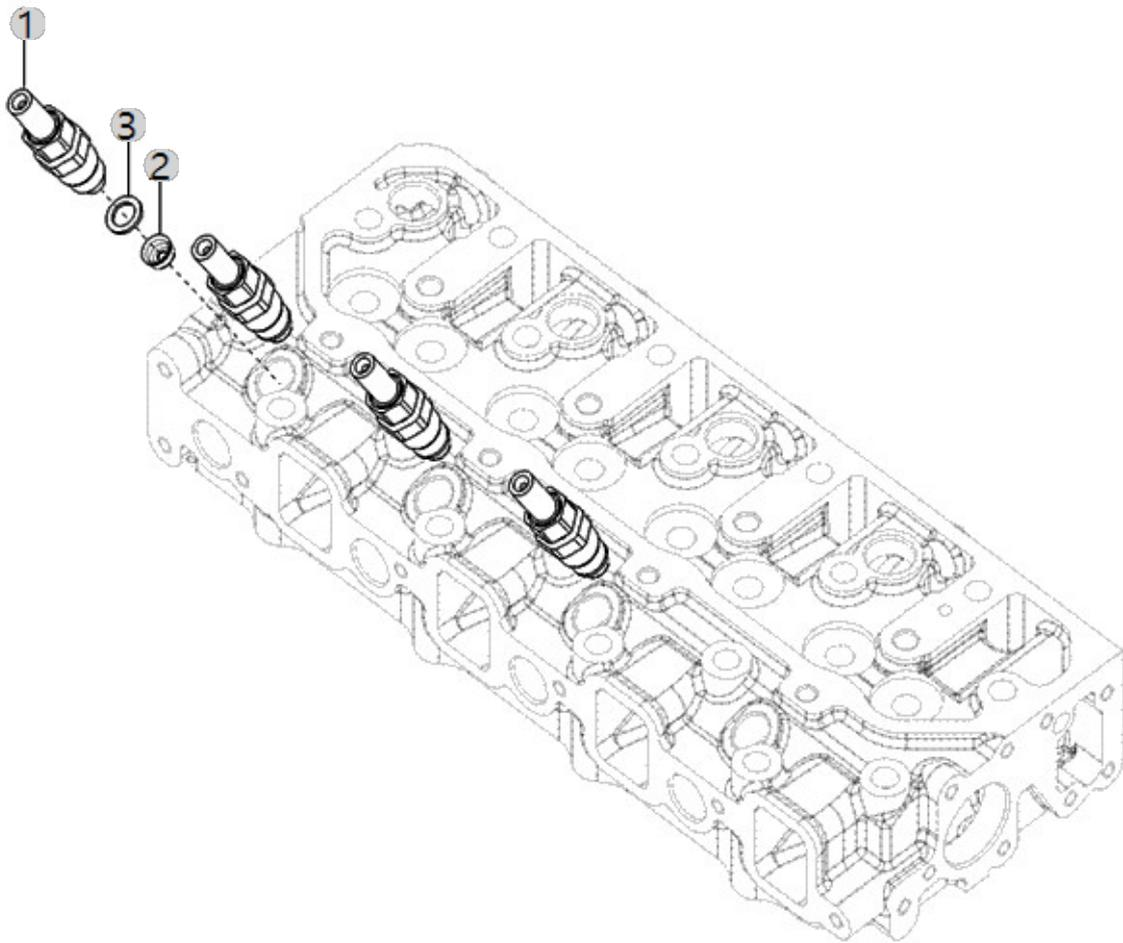



A12\_014

A2300N4-UTR\_4  
(AB00277)

# FUEL INJECTOR

Year/Month

2022-12-19

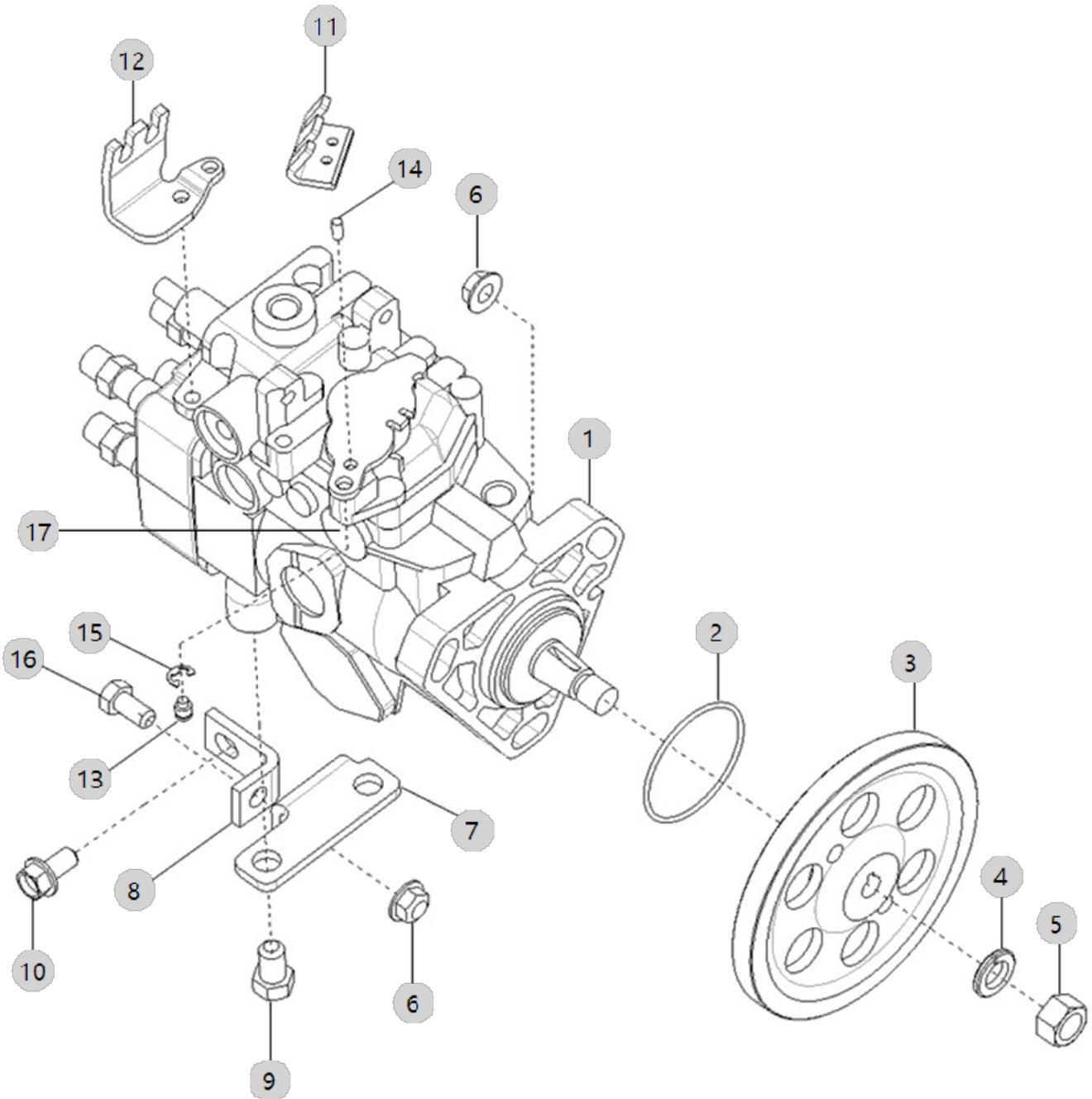



A13\_005

A2300N4-UTR\_4  
(AB00277)

PLUMBING, FUEL

Year/Month

2022-12-19

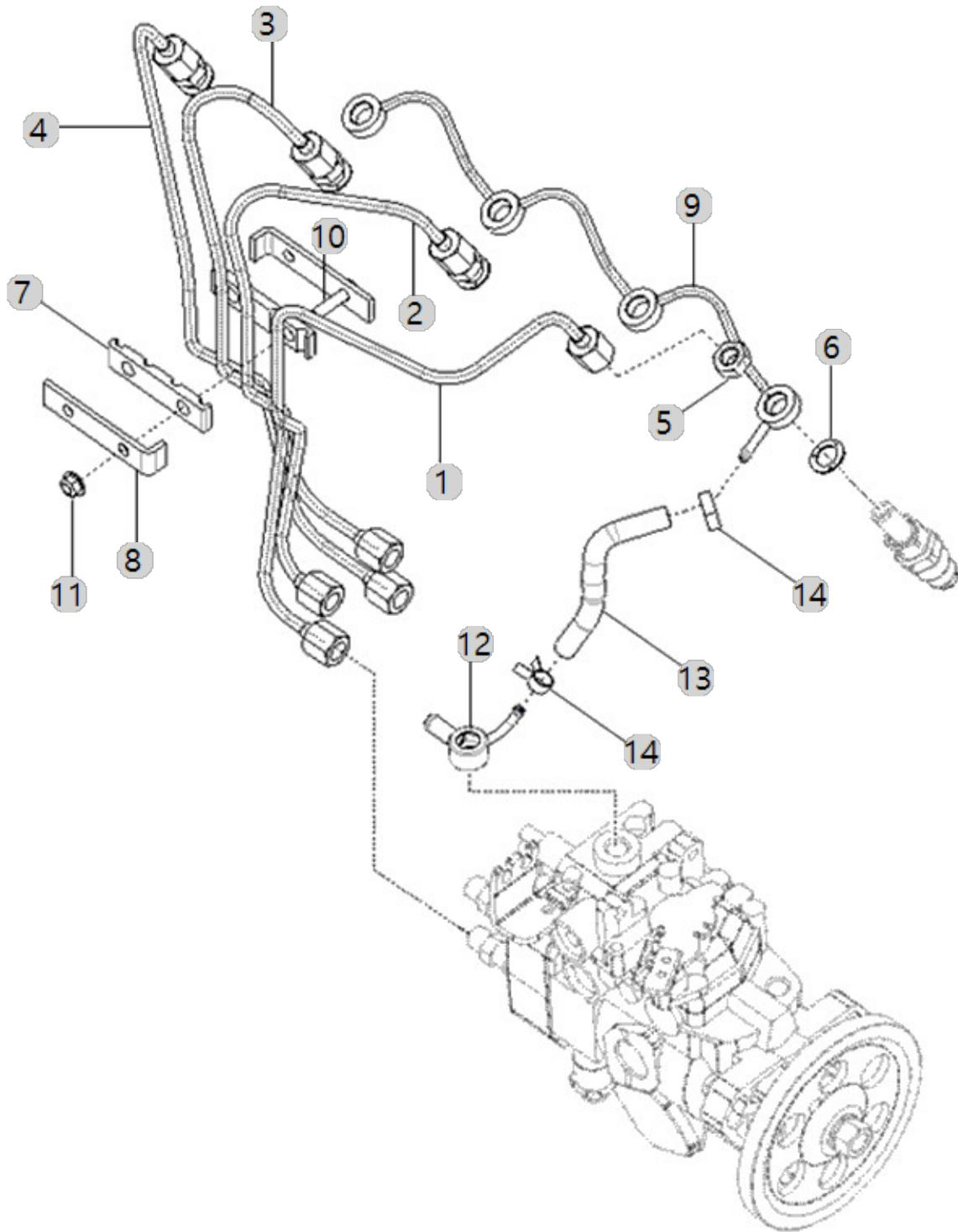

A13_005 A2300N4-UTR_4 (AB00277)		PLUMBING, FUEL				Year/Month 2022-12-19
순번 (NO)	부품번호 (PART NO)	품명 (PART NAME)	품명 (PART NAME)	수량 (QTY)	규격 (SPEC)	비고 (REMARK)
1	HRA150050DC0	연료파이프조합(A)	TUBE,INJECTOR FUEL SUPPLY	1		
1	HRA150050DB0	299,A202322,연료파이프조합(A)	PIPE ASSY, FUEL SUPPLY A	1		
1	HRA150050DB0	299,A202322,연료파이프조합(A)	PIPE ASSY, FUEL SUPPLY A	1		
1	HRA150050DB0	299,A202322,연료파이프조합(A)	PIPE ASSY, FUEL SUPPLY A	1		
2	HRA150060DB0	300,A202322,연료파이프조합(B)	PIPE ASSY, FUEL SUPPLY (B)	1		
2	HRA150060DC0	연료파이프조합(B)	TUBE,INJECTOR FUEL SUPPLY	1		
2	HRA150060DB0	300,A202322,연료파이프조합(B)	PIPE ASSY, FUEL SUPPLY (B)	1		
2	HRA150060DB0	300,A202322,연료파이프조합(B)	PIPE ASSY, FUEL SUPPLY (B)	1		
3	HRA150070DB0	301,A202322,연료파이프조합(C)	PIPE ASSY, FUEL SUUPPLY C	1		
3	HRA150070DB0	301,A202322,연료파이프조합(C)	PIPE ASSY, FUEL SUUPPLY C	1		
3	HRA150070DB0	301,A202322,연료파이프조합(C)	PIPE ASSY, FUEL SUUPPLY C	1		
3	HRA150070DC0	연료파이프조합(C)	TUBE,INJECTOR FUEL SUPPLY	1		
4	HRA150080DB0	302,A202322,연료파이프조합(D)	PIPE ASSY, FUEL SUPPLY D	1		
4	HRA150080DC0	연료파이프조합(D)	TUBE,INJECTOR FUEL SUPPLY	1		
4	HRA150080DB0	302,A202322,연료파이프조합(D)	PIPE ASSY, FUEL SUPPLY D	1		
4	HRA150080DB0	302,A202322,연료파이프조합(D)	PIPE ASSY, FUEL SUPPLY D	1		
5	HK13450000A4	육각고정너트	NUT,REGULARHEXAGON	4	M12X1.5	
5	HK13450000A4	육각고정너트	NUT,REGULARHEXAGON	4	M12X1.5	
5	HK13450000A4	육각고정너트	NUT,REGULARHEXAGON	4	M12X1.5	
5	HK13450000A4	육각고정너트	NUT,REGULARHEXAGON	4	M12X1.5	
6	HK13440000A4	306,ALL,패킹(조인트)(와류실)	GASKET,FUELMANIFOLD	4		
6	HK13440000A4	306,ALL,패킹(조인트)(와류실)	GASKET,FUELMANIFOLD	4		
6	HK13440000A4	306,ALL,패킹(조인트)(와류실)	GASKET,FUELMANIFOLD	4		
6	HK13440000A4	306,ALL,패킹(조인트)(와류실)	GASKET,FUELMANIFOLD	4		
7	HRA1502700A4	462,ALL,브래킷고무	RUBBER,BRACKET	2		
7	HRA1502700A4	462,ALL,브래킷고무	RUBBER,BRACKET	2		
7	HRA1502700A4	462,ALL,브래킷고무	RUBBER,BRACKET	2		
7	HRA1502700A4	462,ALL,브래킷고무	RUBBER,BRACKET	2		
8	HRA1502800A4	브래킷판	CLAMP,TUBE	1	T 3.2	
8	HRA1502800A4	브래킷판	CLAMP,TUBE	1	T 3.2	
8	HRA1502800A4	브래킷판	CLAMP,TUBE	1	T 3.2	
8	HRA1502800A4	브래킷판	CLAMP,TUBE	2	T 3.2	
8	HRA1502800B4	브래킷판	CLAMP,TUBE	2	T 3.2	
9	HRA1500900D3	퇴유파이프조합	PIPE ASSY, FUEL	1		
9	HRA1500900C3	퇴유파이프조합	PIPE ASSY, FUEL RETURN	1		
9	HRA1500900C3	퇴유파이프조합	PIPE ASSY, FUEL RETURN	1		
9	HRA1500900C3	퇴유파이프조합	PIPE ASSY, FUEL RETURN	1		
10	HRA1502600B4	브래킷(연료파이프)	BRACKET,PIPE	1		
10	HRA1502600B4	브래킷(연료파이프)	BRACKET,PIPE	1		
10	HRA1502600B4	브래킷(연료파이프)	BRACKET,PIPE	1		
10	HRA1502600B4	브래킷(연료파이프)	BRACKET,PIPE	1		
11	26367-060002	플랜지너트	Nut, Hexa (Φ6)	2	M6XP1.0	
11	26367-060002	플랜지너트	Nut, Hexa (Φ6)	2	M6XP1.0	
11	26367-060002	플랜지너트	Nut, Hexa (Φ6)	2	M6XP1.0	
11	26367-060002	플랜지너트	Nut, Hexa (Φ6)	2	M6XP1.0	





A14\_003

A2300N4-UTR\_4  
(AB00277)

### FUEL FILTER BRACKET

Year/Month

2022-12-19

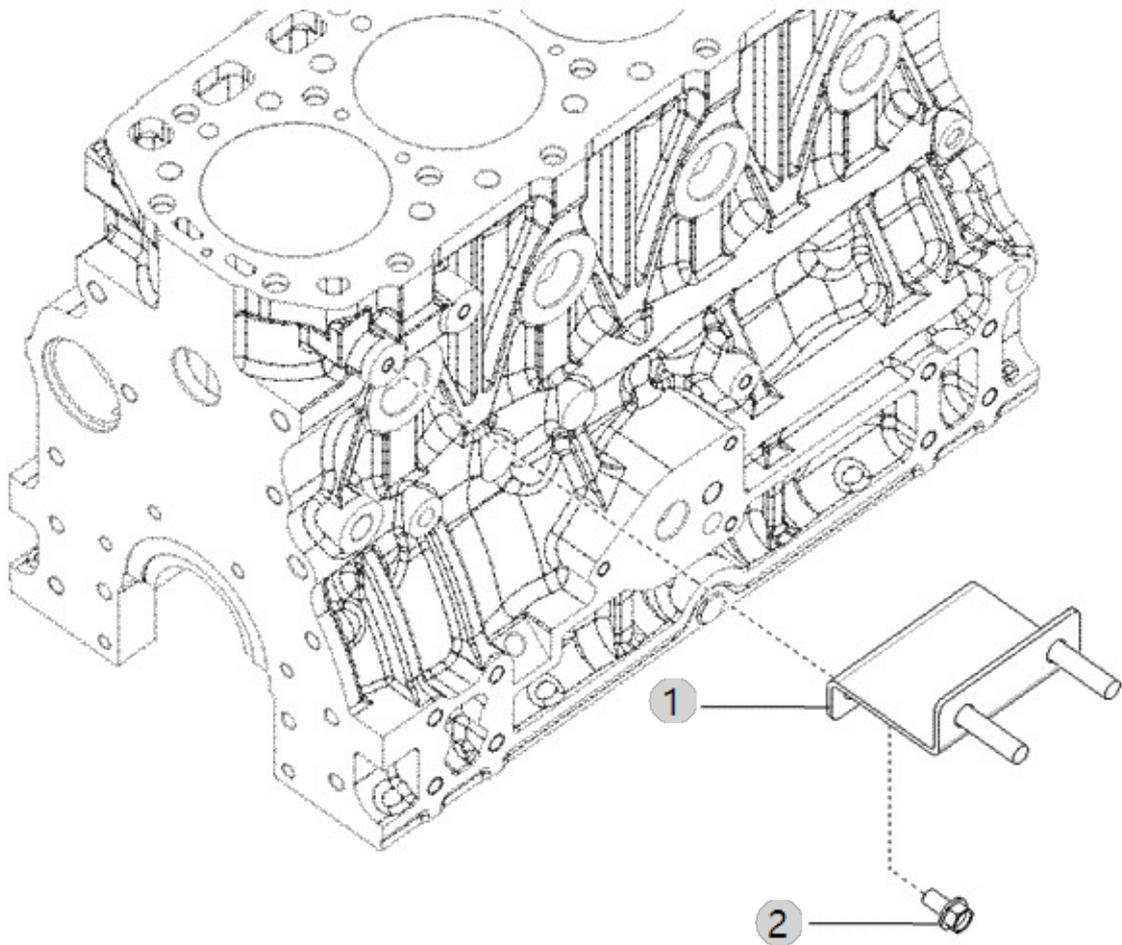



A16\_018

A2300N4-UTR\_4  
(AB00277)

FUEL FILTER ASS'Y OPTION

Year/Month

2022-12-19

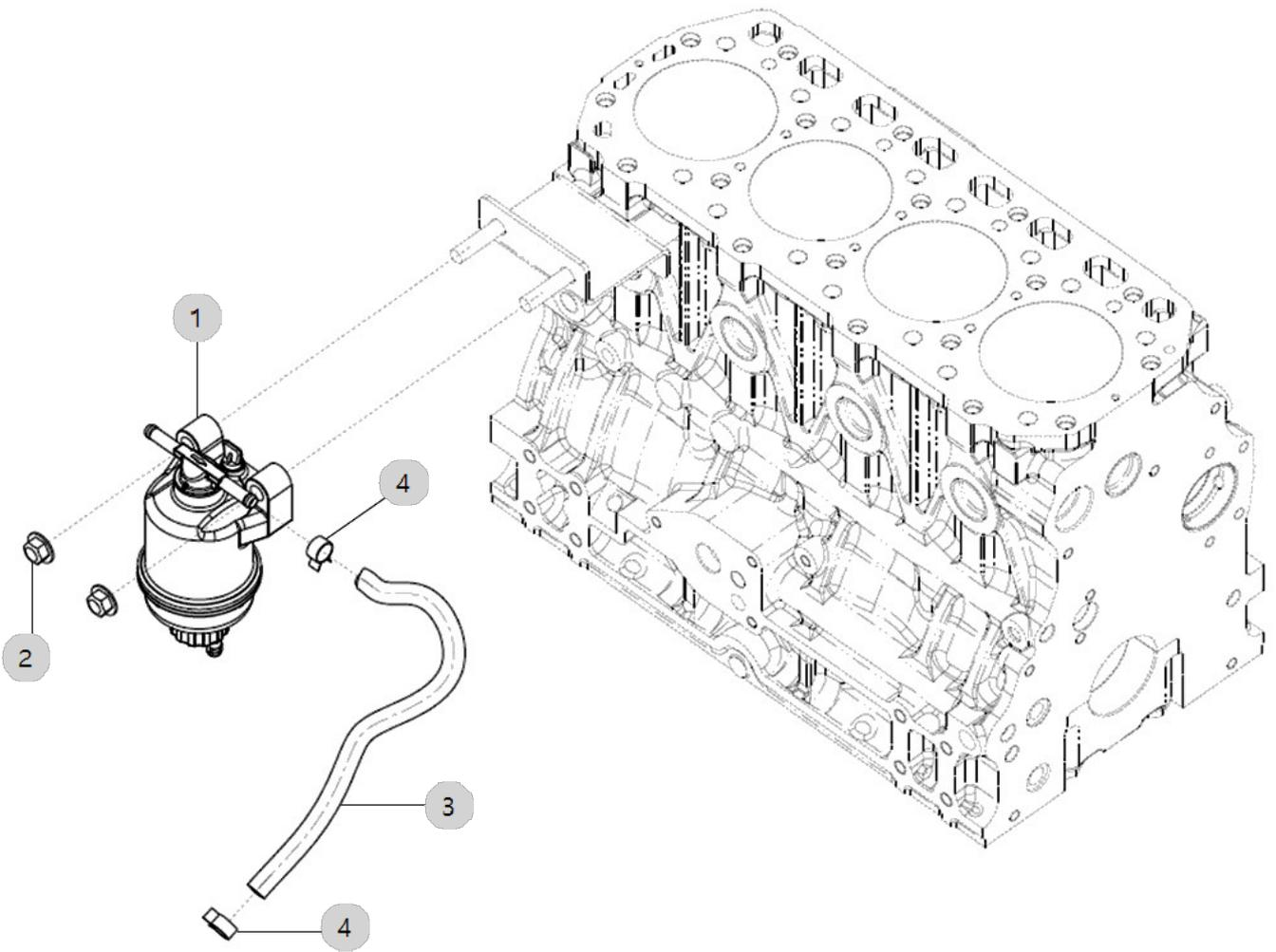



A17\_014

A2300N4-UTR\_4  
(AB00277)

INTAKE MANIFOLD ASS'Y OPTION

Year/Month

2022-12-19

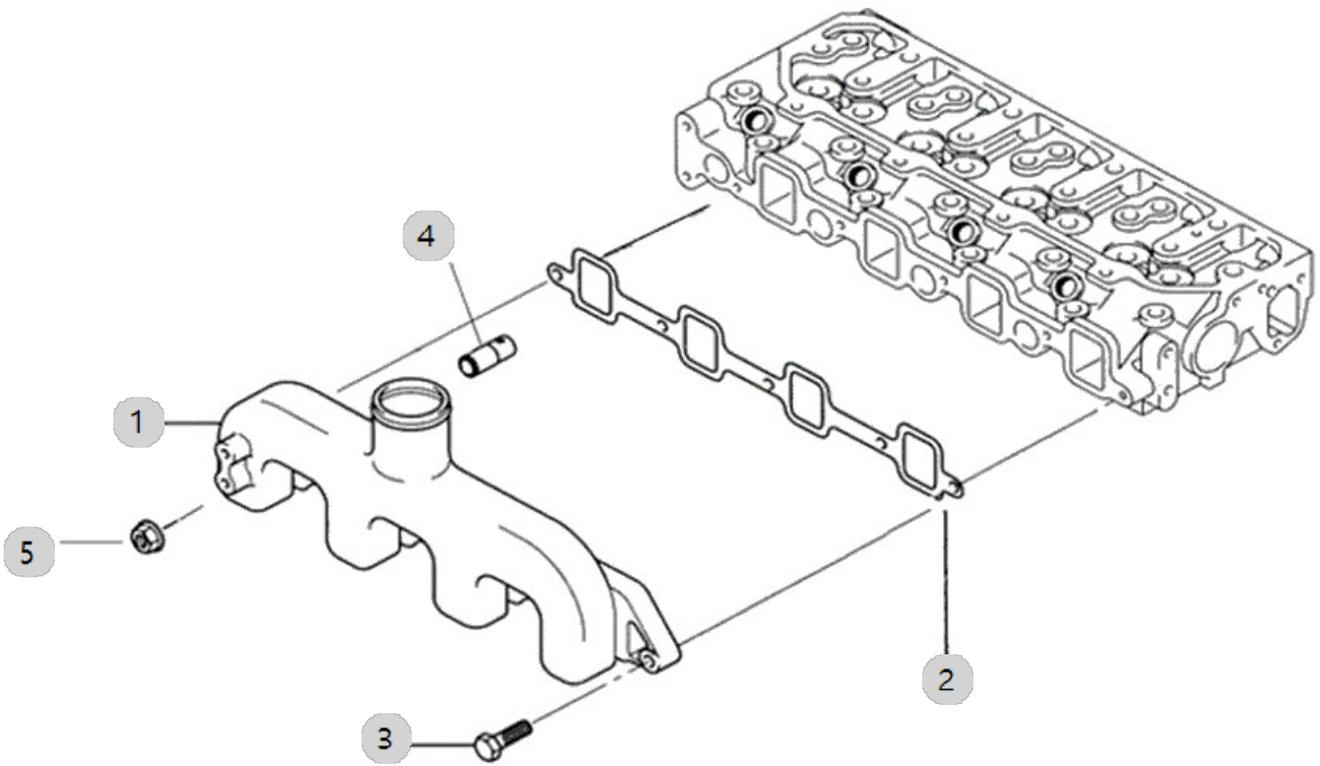



A18\_011

A2300N4-UTR\_4  
(AB00277)

# FLYWHEEL

Year/Month

2022-12-19

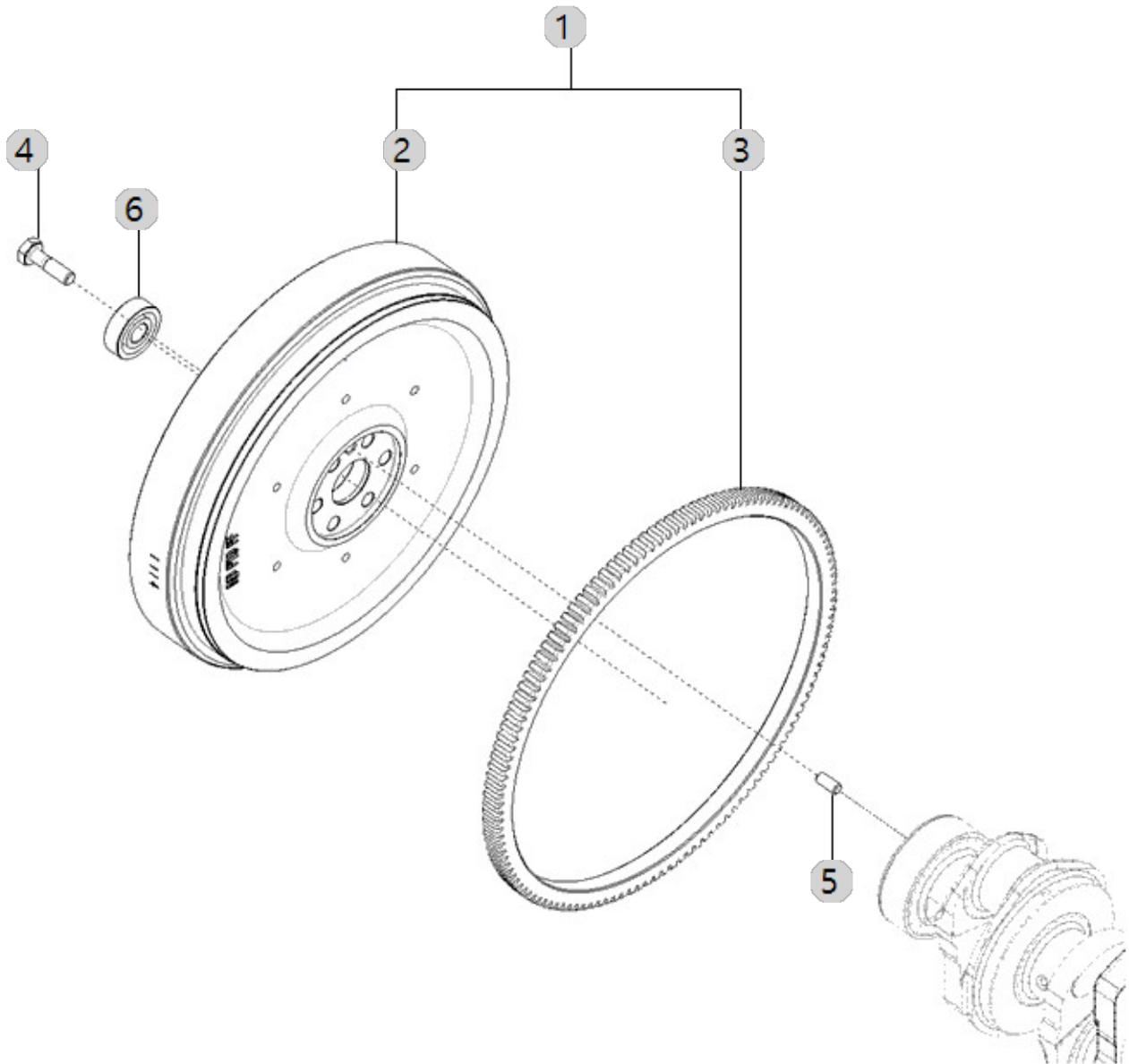





A19\_007

A2300N4-UTR\_4  
(AB00277)

# FLYWHEEL HOUSING

Year/Month

2022-12-19

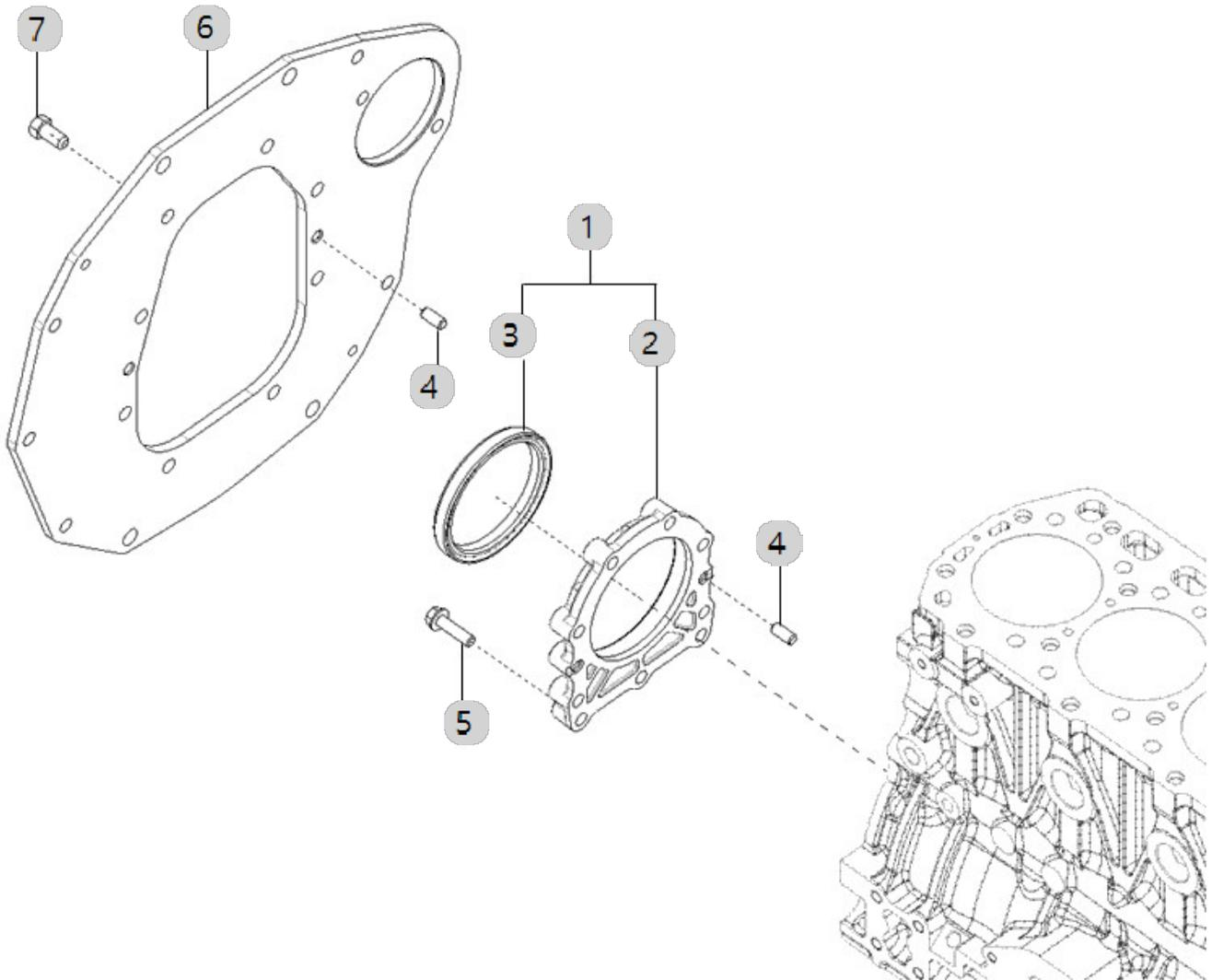



A20\_010

A2300N4-UTR\_4  
(AB00277)

HEAD, CYLINDER

Year/Month

2022-12-19

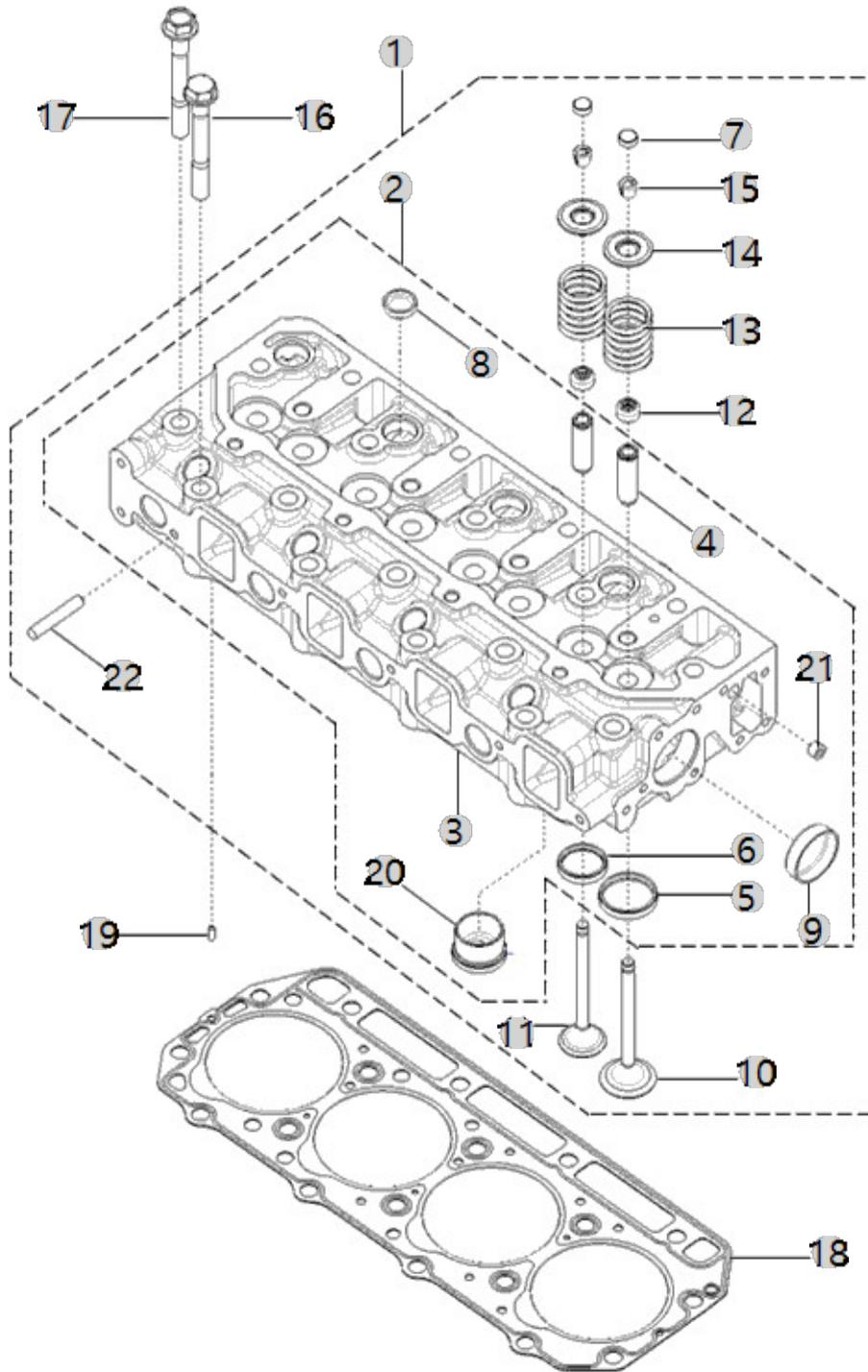



A21\_004

A2300N4-UTR\_4  
(AB00277)

# HEAD COVER

Year/Month

2022-12-19

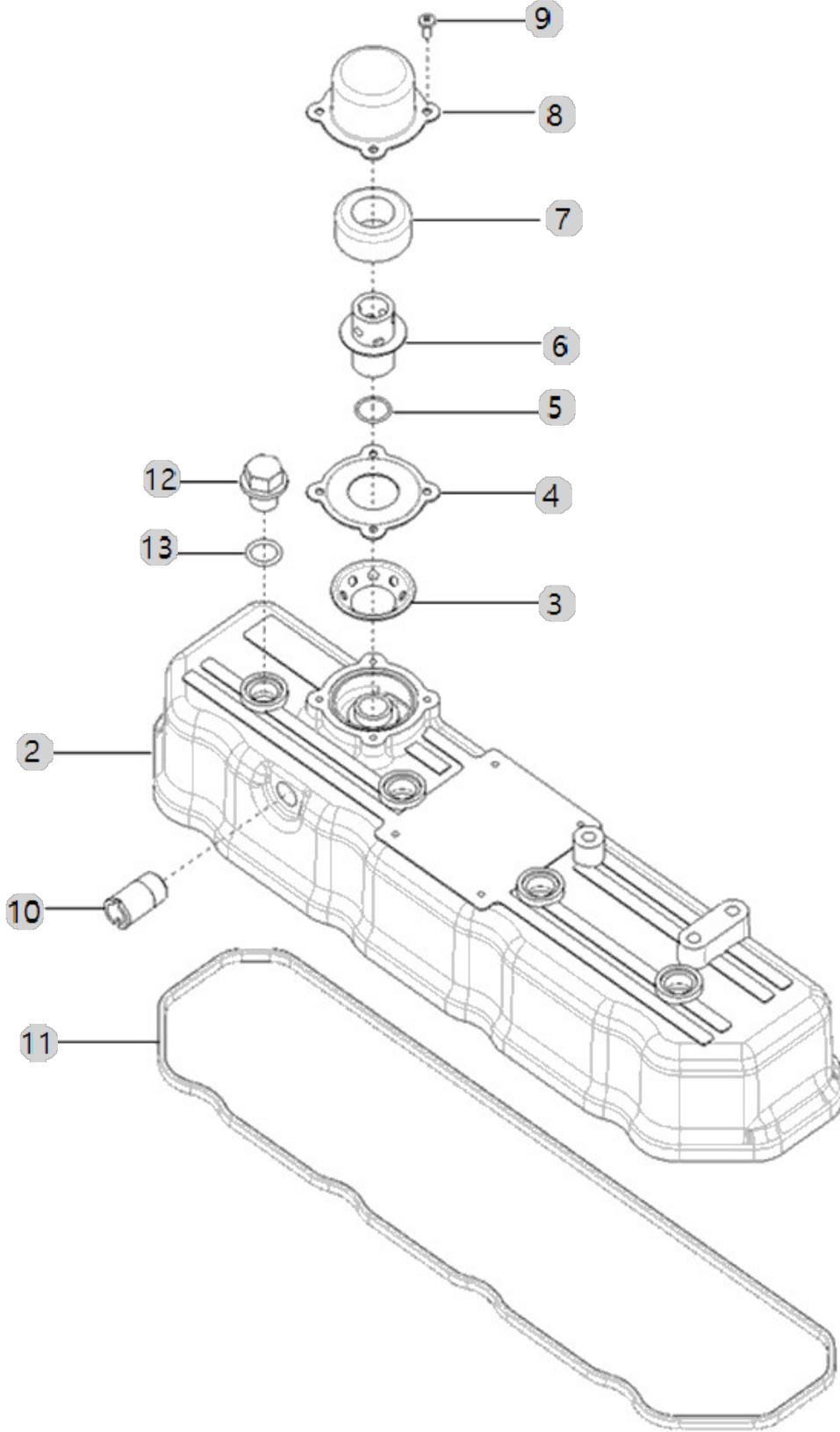



A23\_009

A2300N4-UTR\_4  
(AB00277)

TURBOCHARGER SUPPORT ASS'Y OPTION

Year/Month

2022-12-19

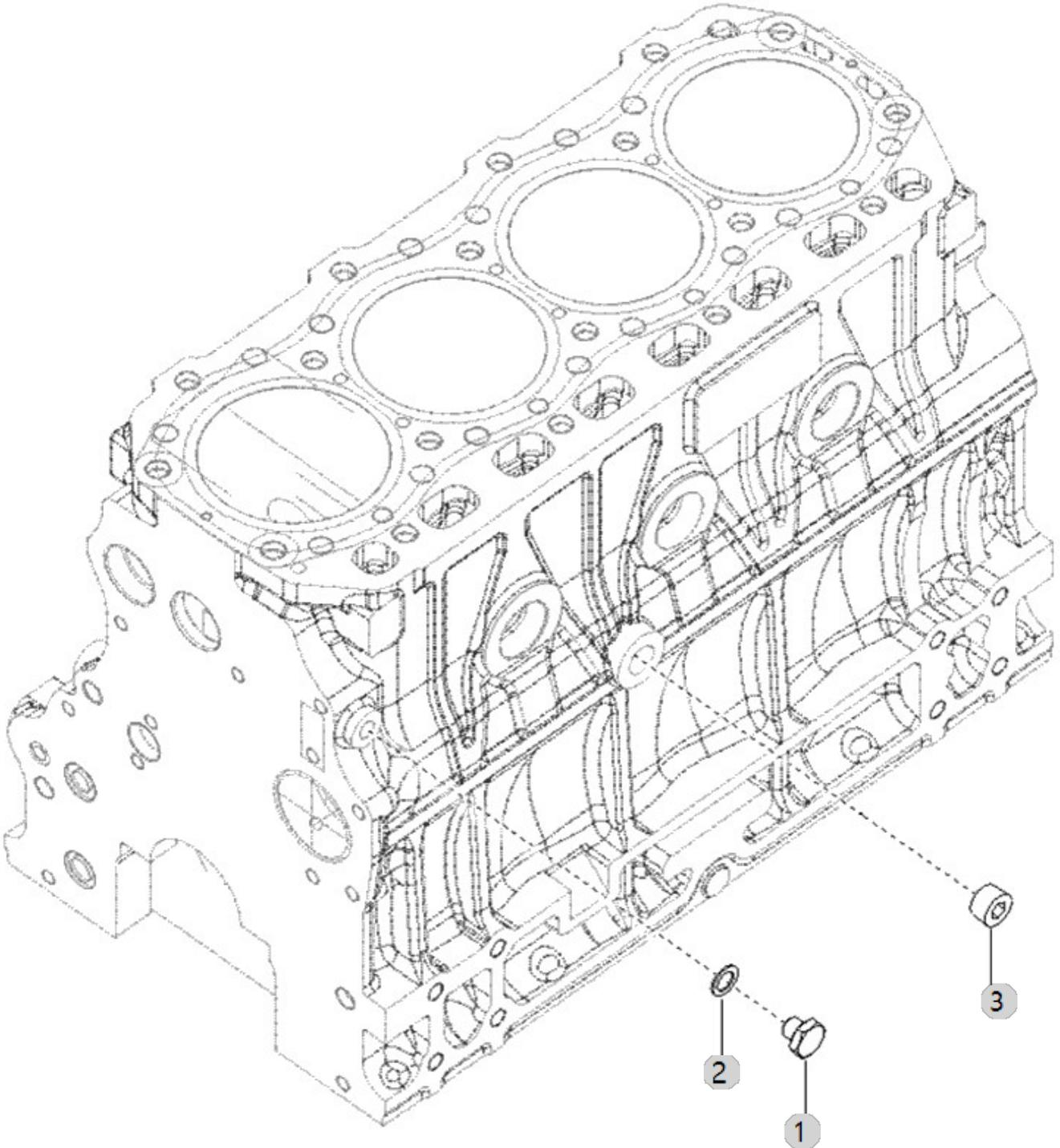





A25\_002

A2300N4-UTR\_4  
(AB00277)

### OIL JET ASS'Y OPTION

Year/Month

2022-12-19

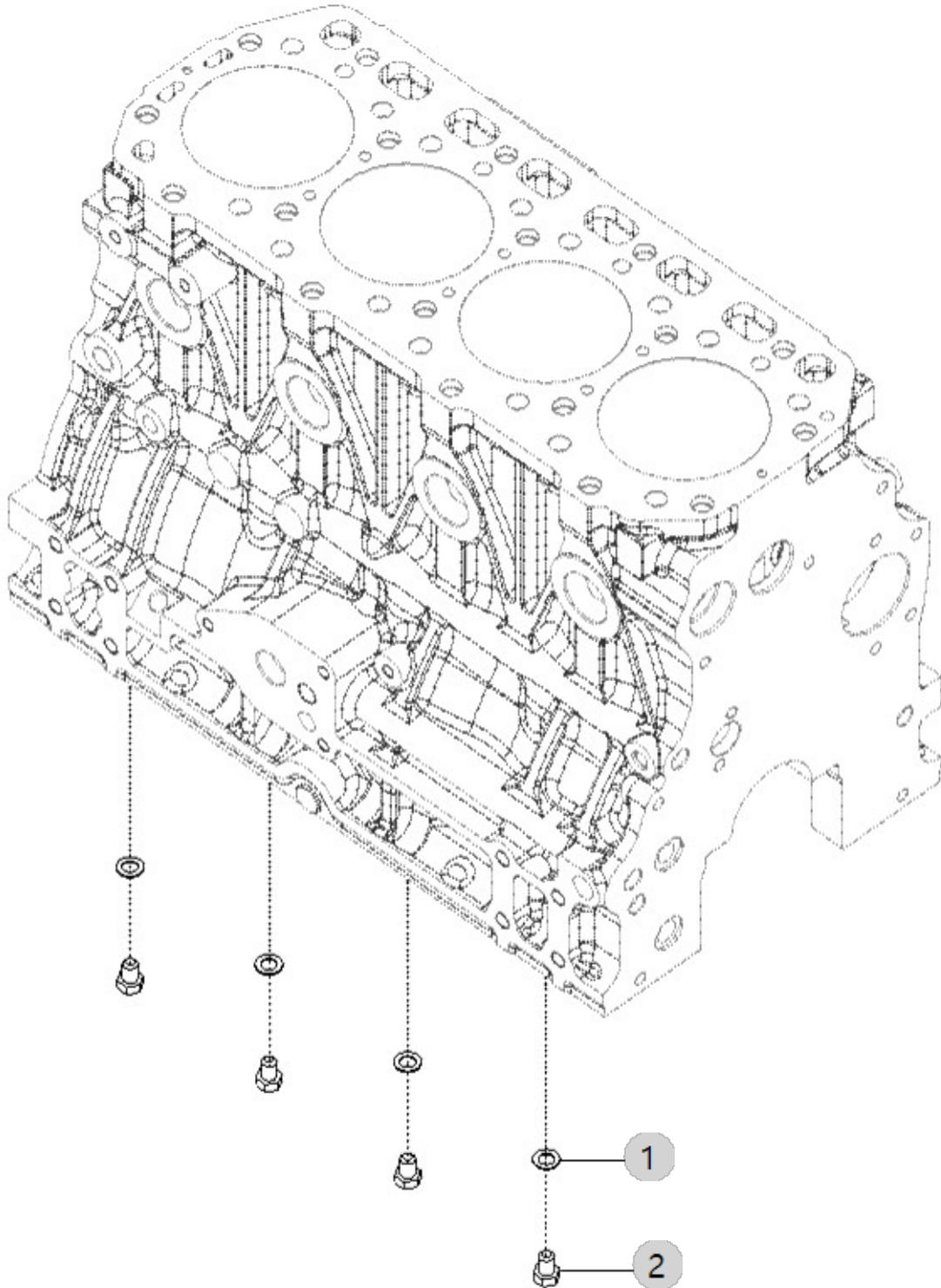



A26\_005

A2300N4-UTR\_4  
(AB00277)

COOLER, ENGINE OIL

Year/Month

2022-12-19

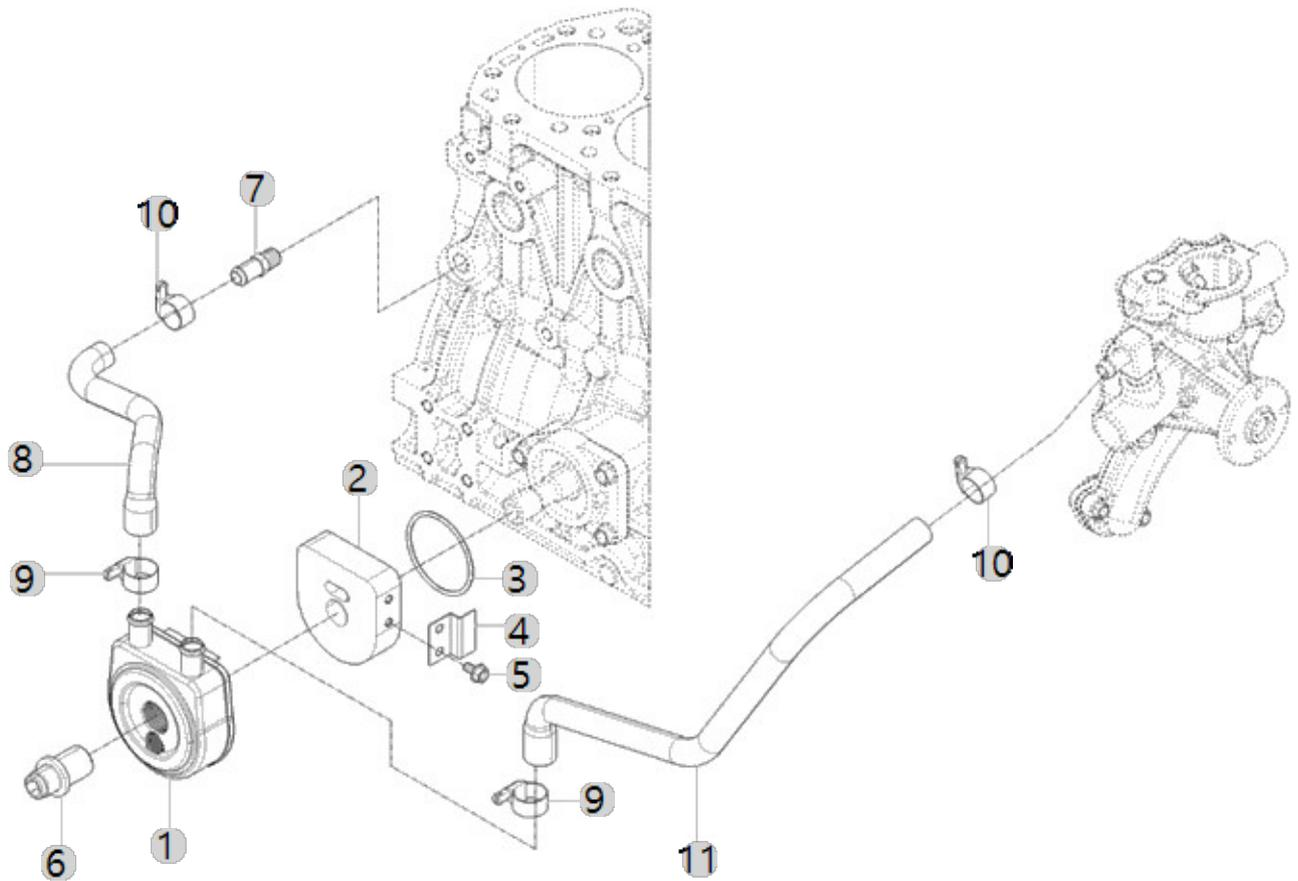



A27\_005

A2300N4-UTR\_4  
(AB00277)

OIL PAN ASS'Y OPTION

Year/Month

2022-12-19

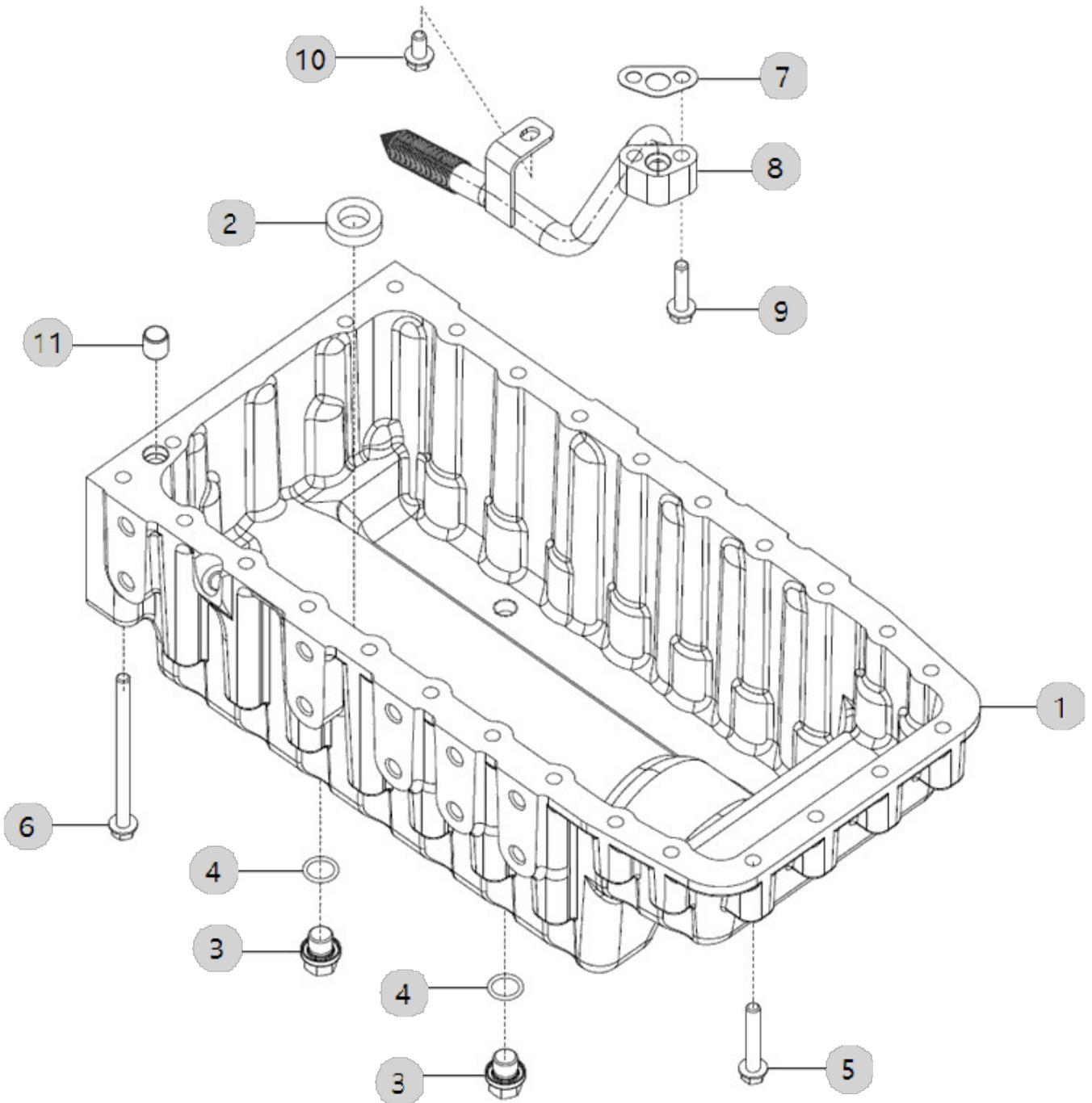



A28\_001

A2300N4-UTR\_4  
(AB00277)

PUMP, LUBRICATING OIL

Year/Month

2022-12-19

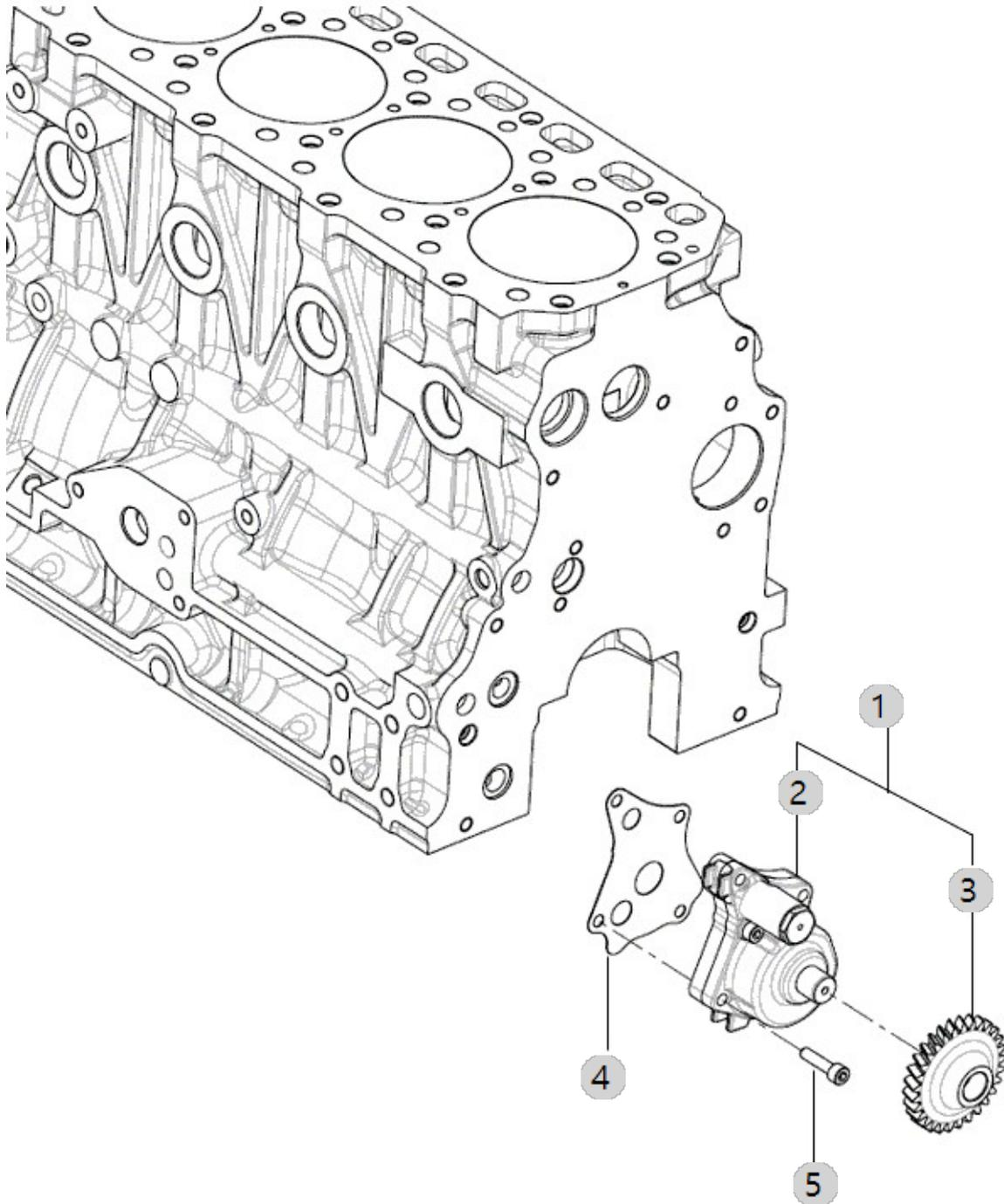





A29\_005

A2300N4-UTR\_4  
(AB00277)

FILTER, LUBRICATING OIL

Year/Month

2022-12-19

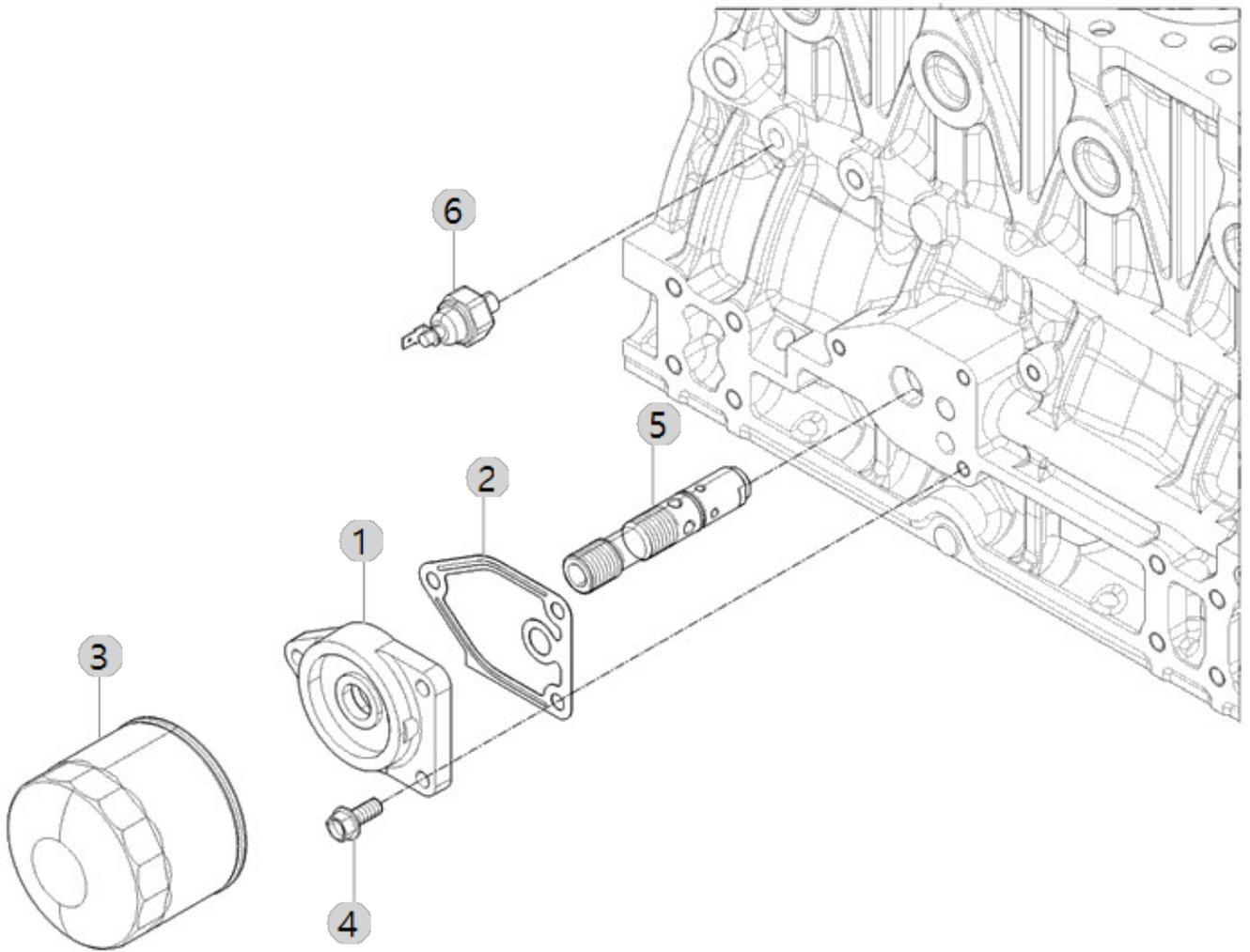



A30\_003

A2300N4-UTR\_4  
(AB00277)

FRONT GEAR ACCESSORY DRIVE

Year/Month

2022-12-19

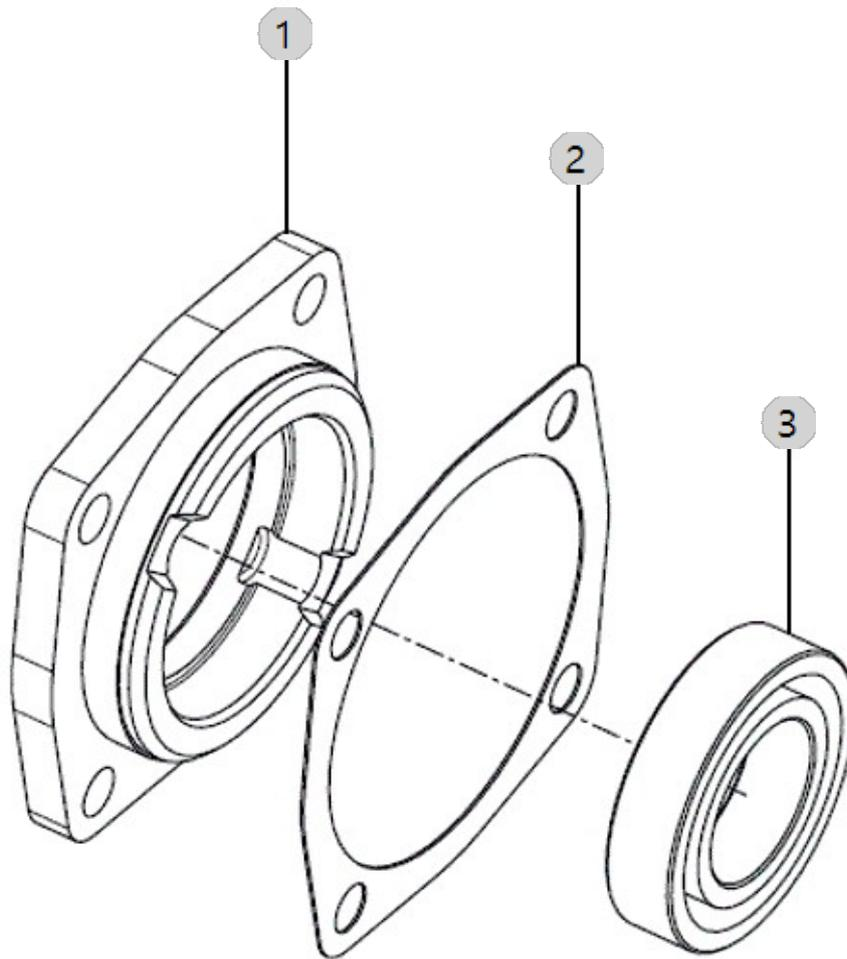



A31\_007

A2300N4-UTR\_4  
(AB00277)

PISTON

Year/Month

2022-12-19

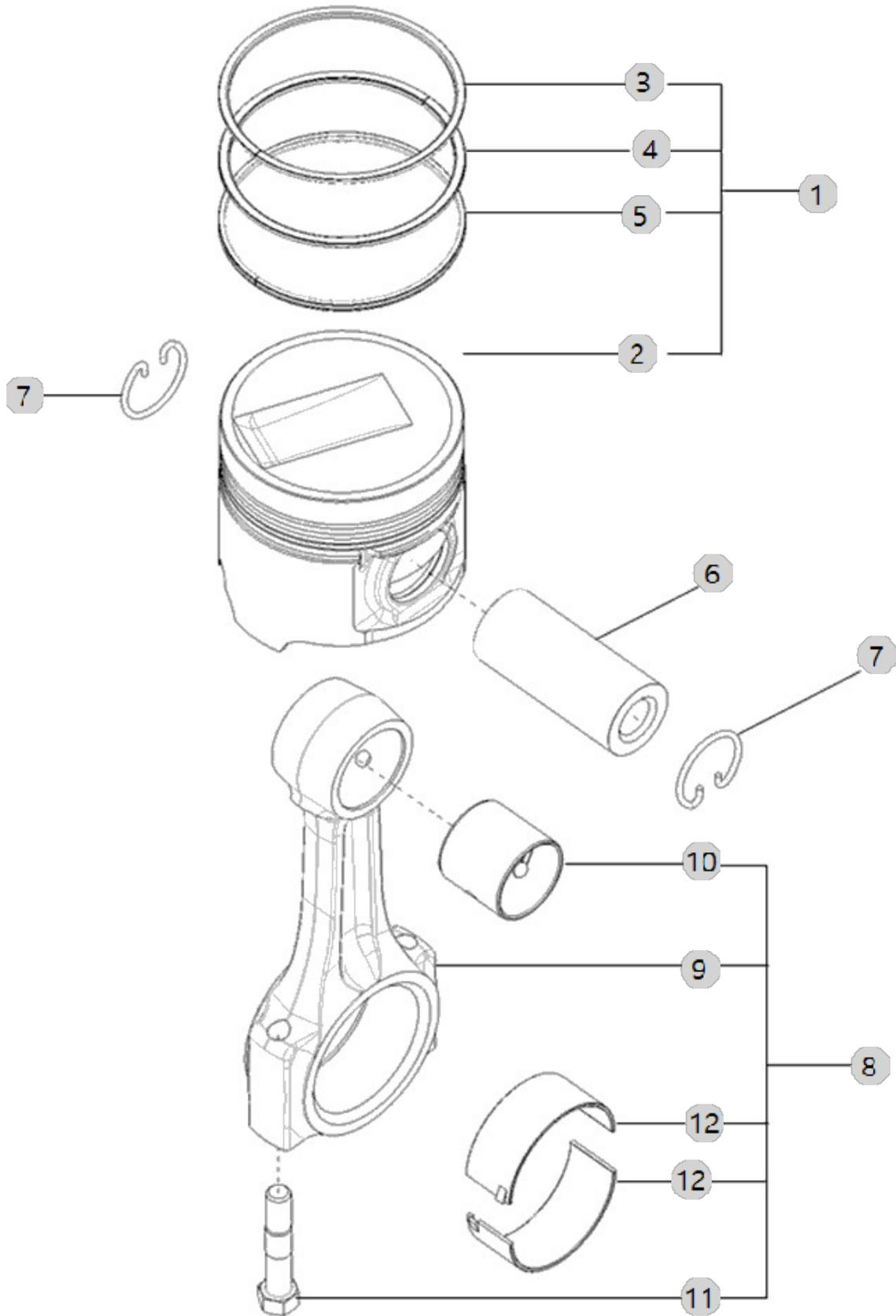



A32\_003

A2300N4-UTR\_4  
(AB00277)

# LEVER, LOCKER

Year/Month

2022-12-19

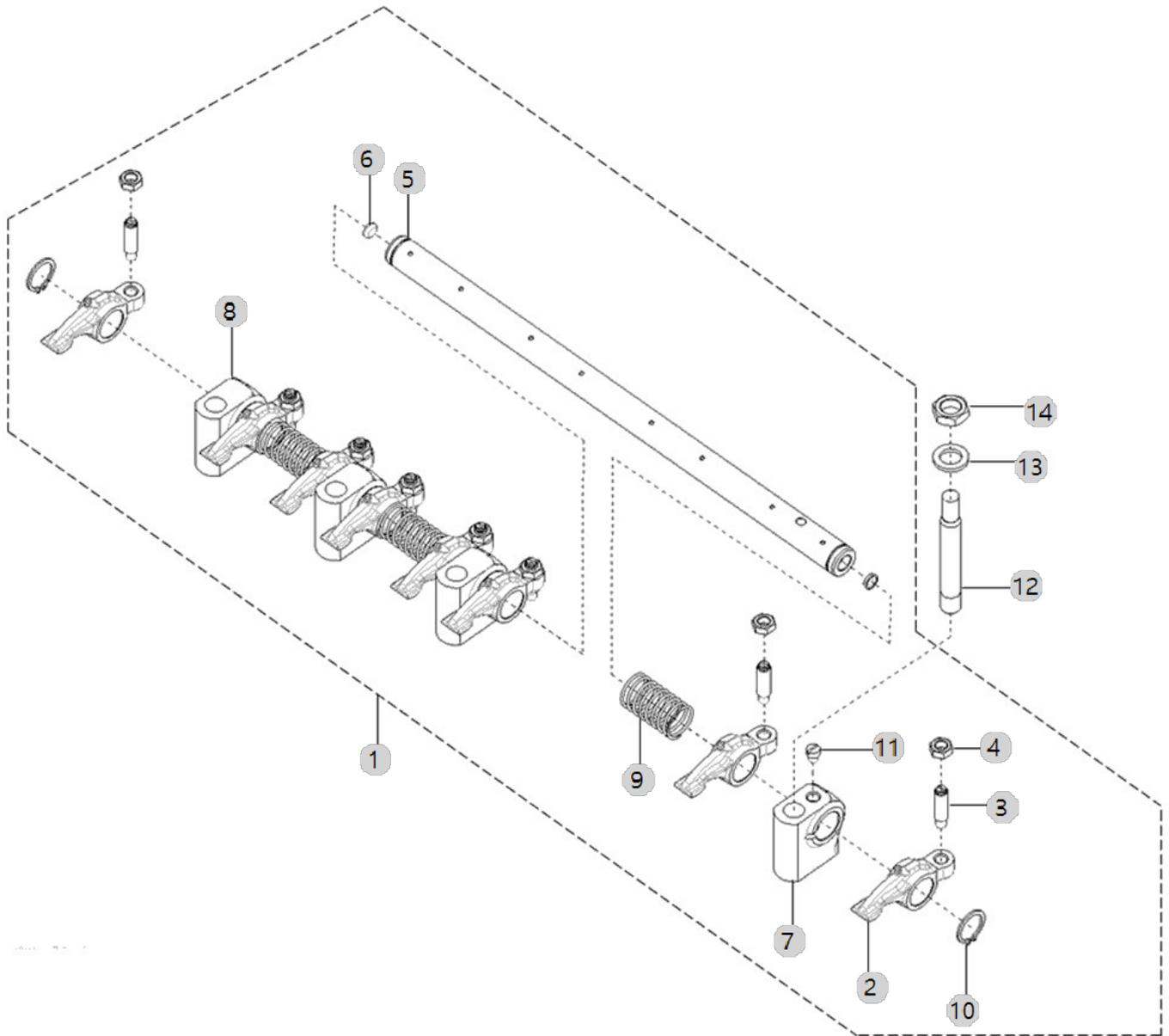





A33\_013

A2300N4-UTR\_4  
(AB00277)

# EXHAUST MANIFOLD

Year/Month

2022-12-19

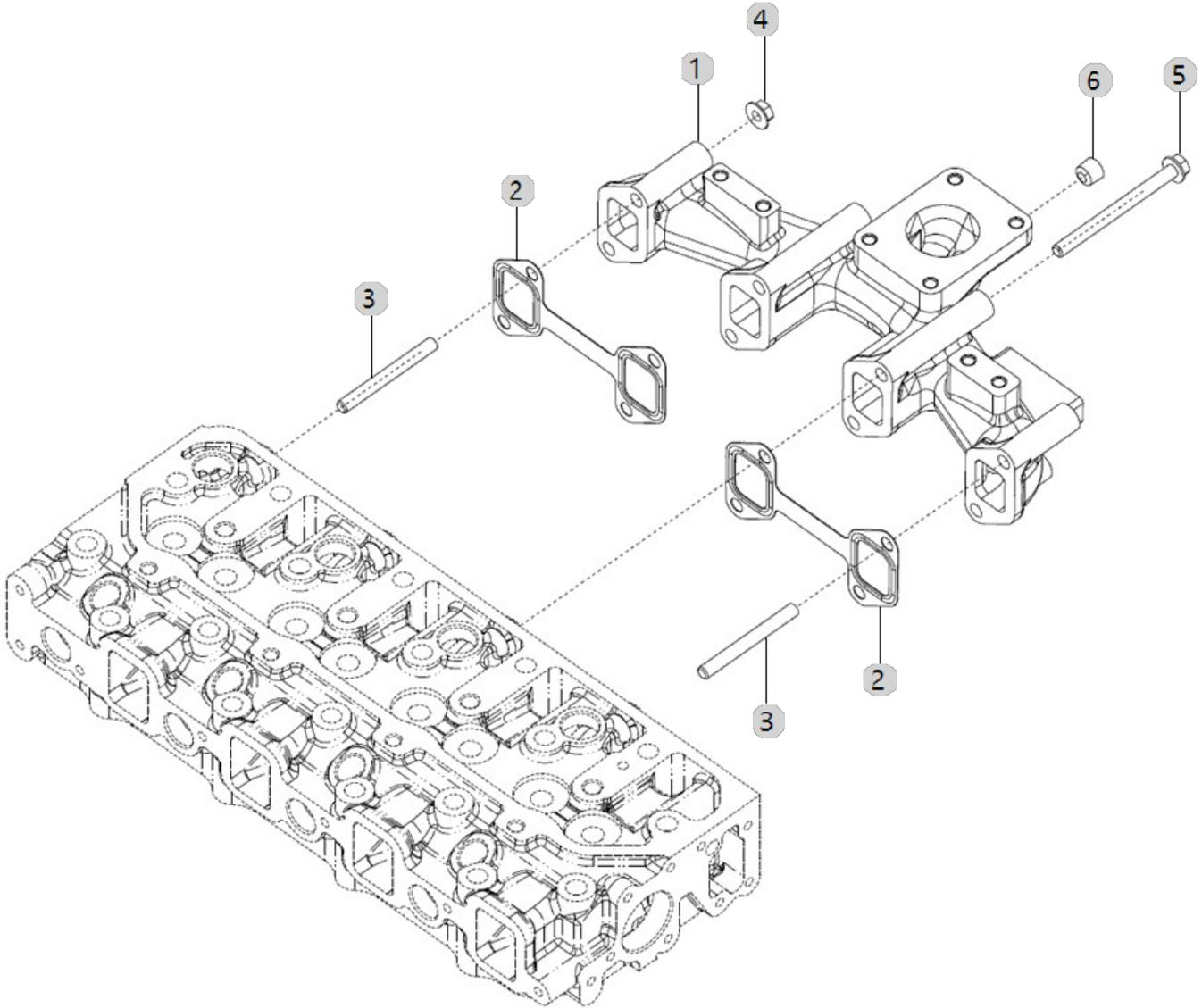



A35\_002

A2300N4-UTR\_4  
(AB00277)

# IDLE GEAR

Year/Month

2022-12-19

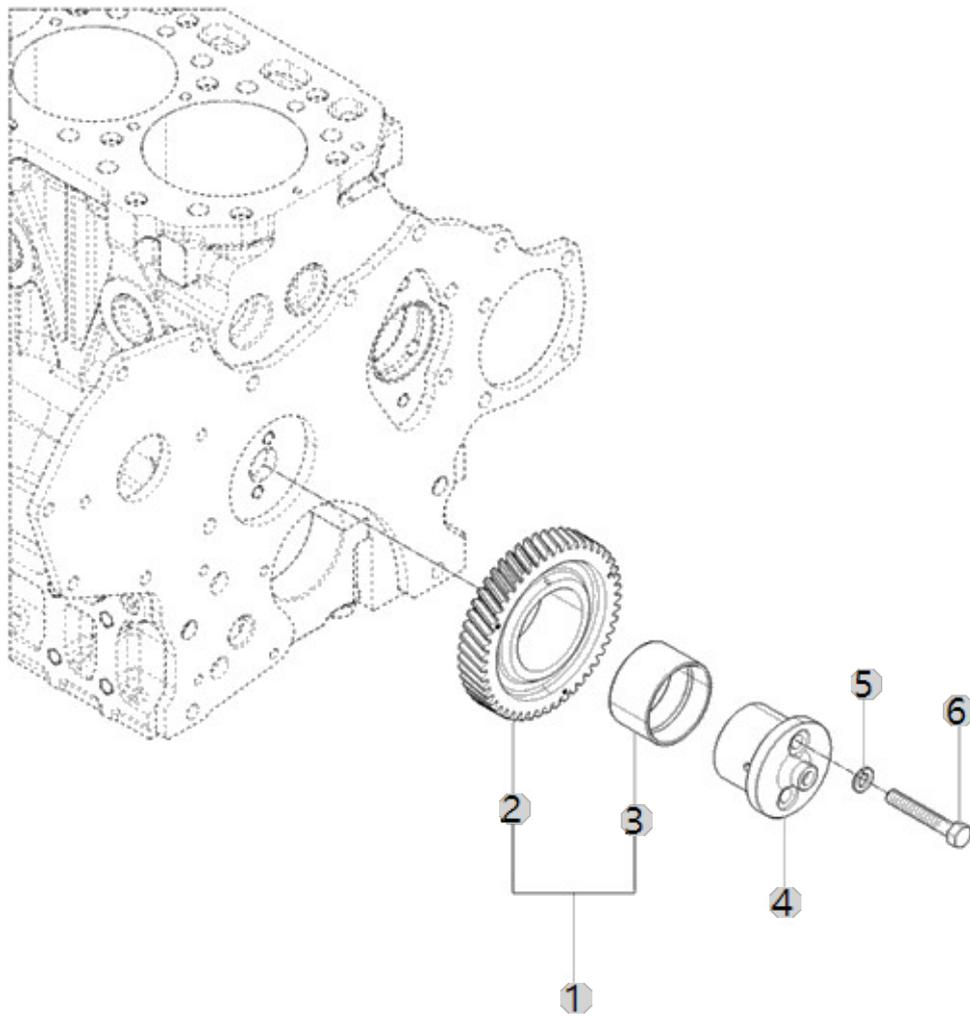



A36\_004

A2300N4-UTR\_4  
(AB00277)

### COVER, FRONT GEAR

Year/Month

2022-12-19

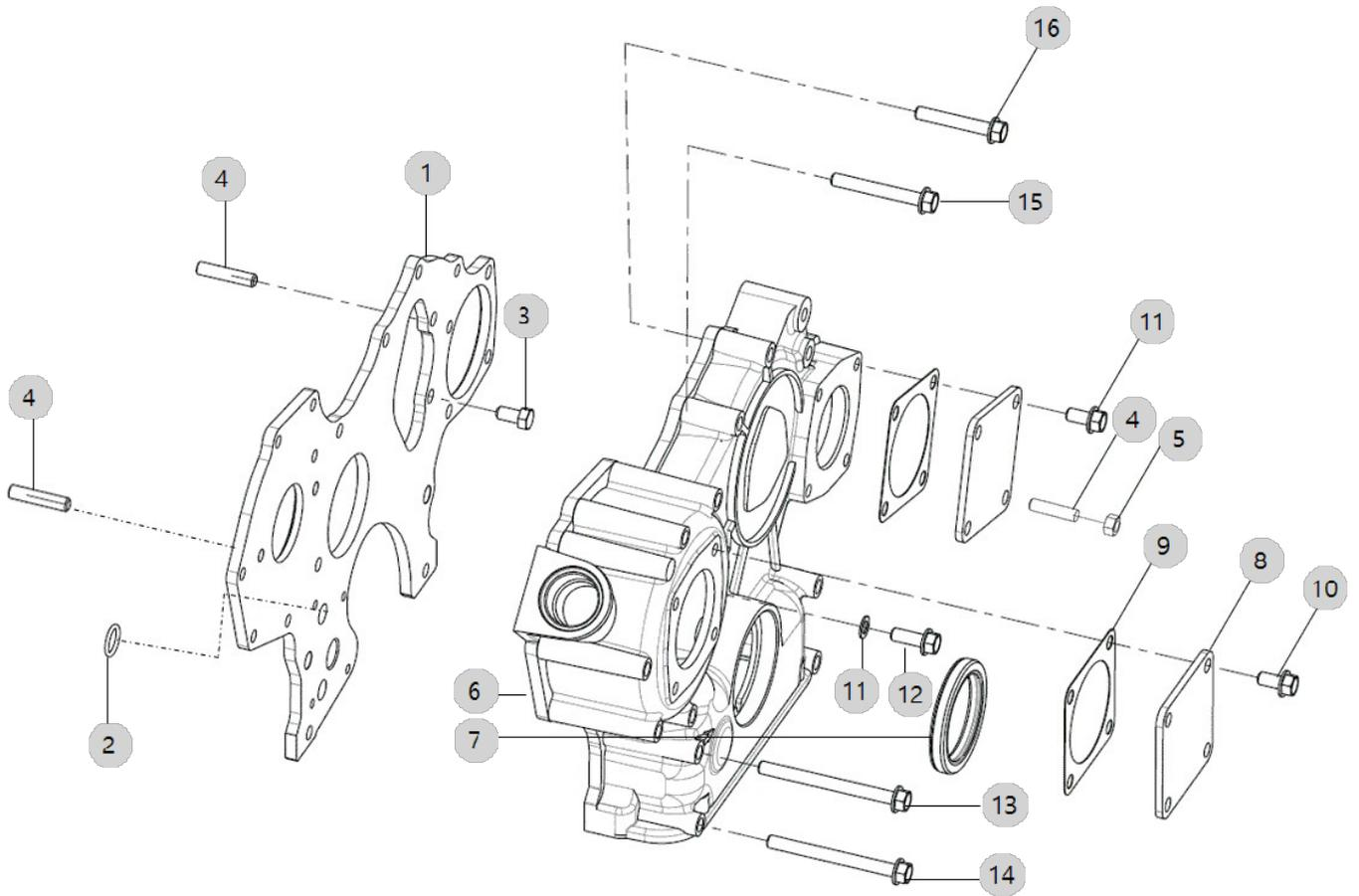



A37\_001

A2300N4-UTR\_4  
(AB00277)

BALANCE ASS'Y

Year/Month

2022-12-19

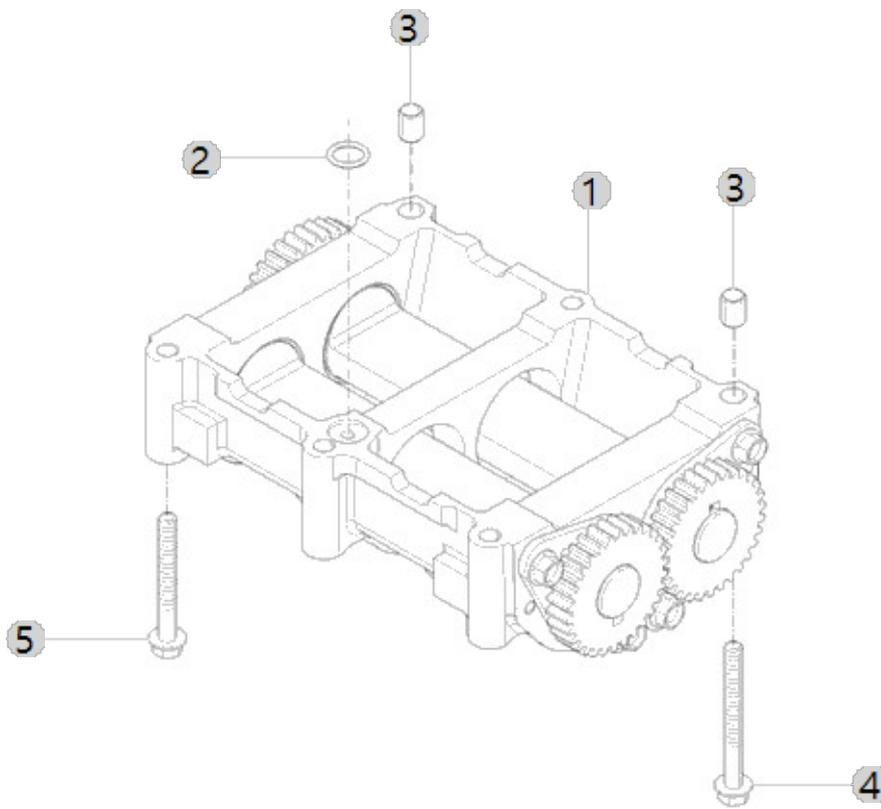





A38\_009

A2300N4-UTR\_4  
(AB00277)

GAUGE, OIL LEVEL

Year/Month

2022-12-19

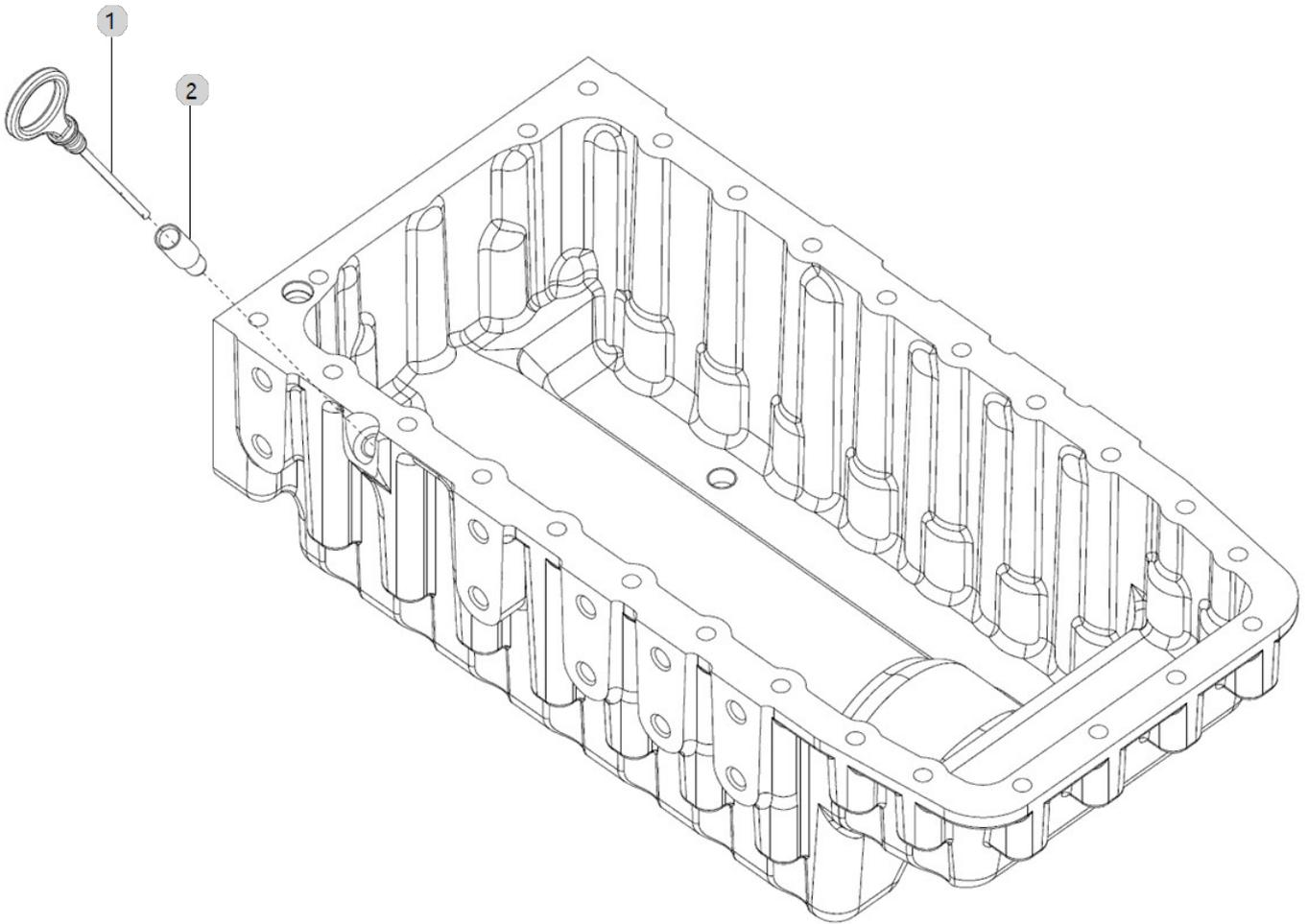



A39\_001

A2300N4-UTR\_4  
(AB00277)

### OIL FILLER CAP

Year/Month

2022-12-19

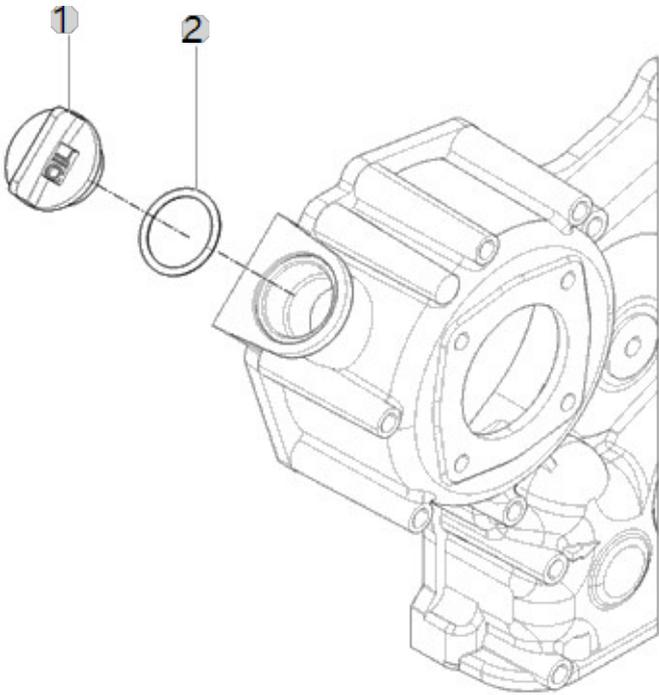



A40\_003

A2300N4-UTR\_4  
(AB00277)

LIFT ASS'Y OPTION

Year/Month

2022-12-19

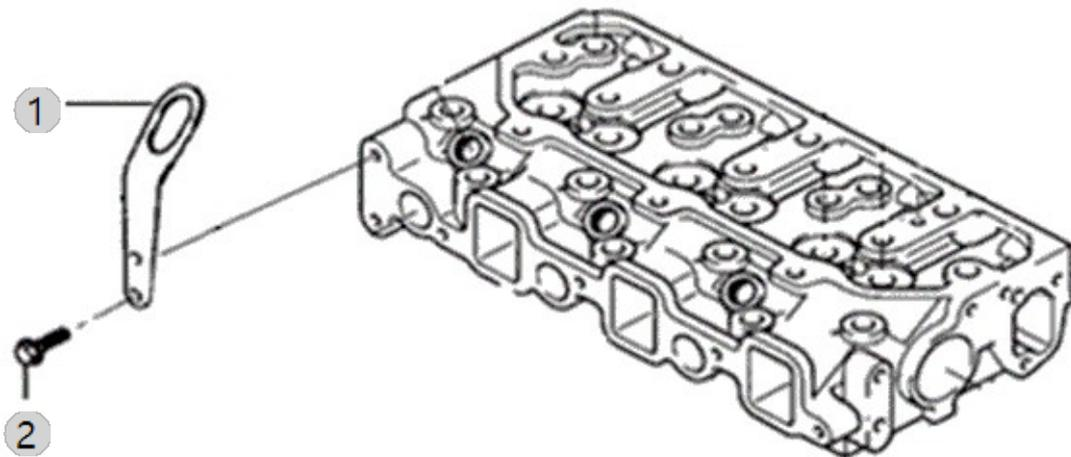



A42\_003

A2300N4-UTR\_4  
(AB00277)

### MOTER, STARTIONS

Year/Month

2022-12-19

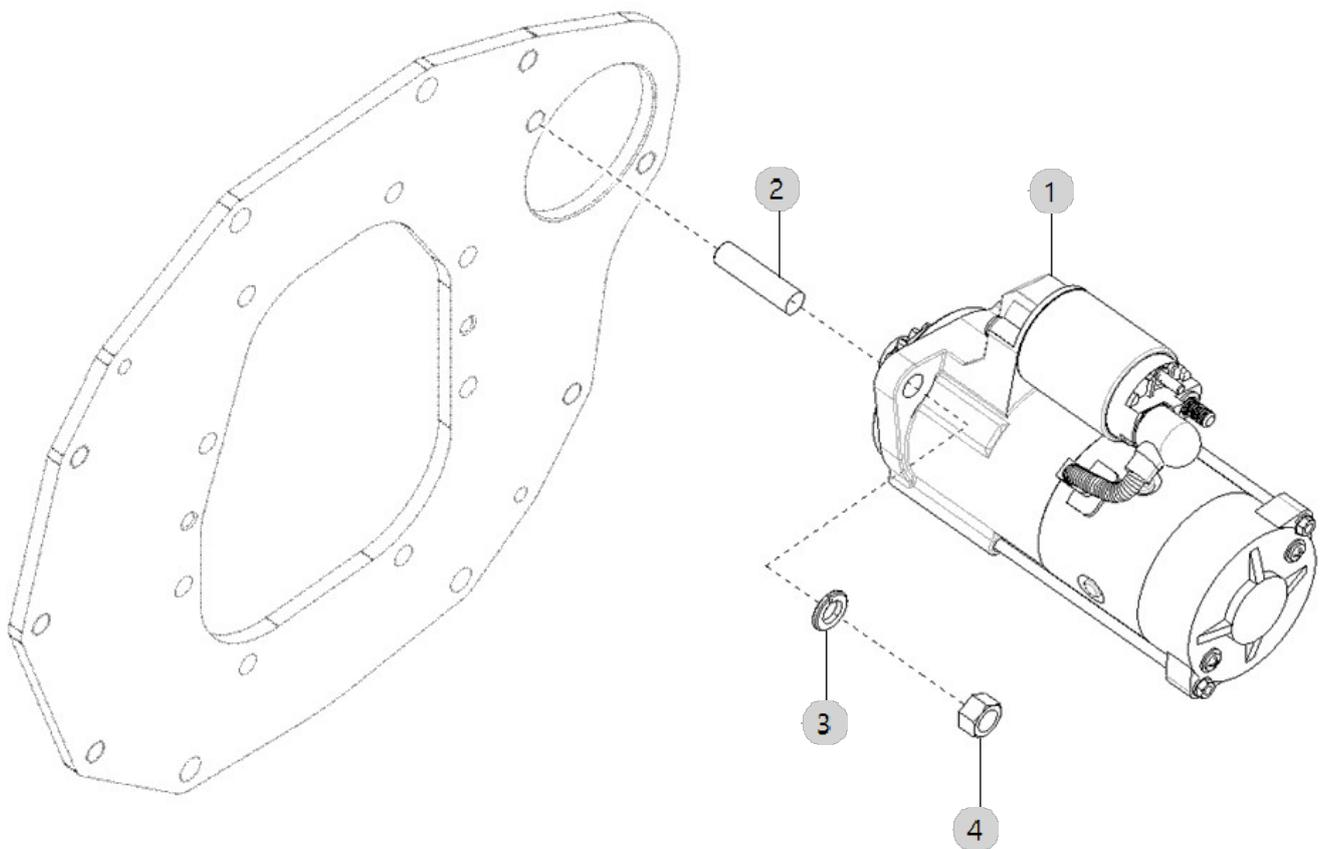





A43\_001

A2300N4-UTR\_4  
(AB00277)

DPF SUPPORT OPTION

Year/Month

2022-12-19

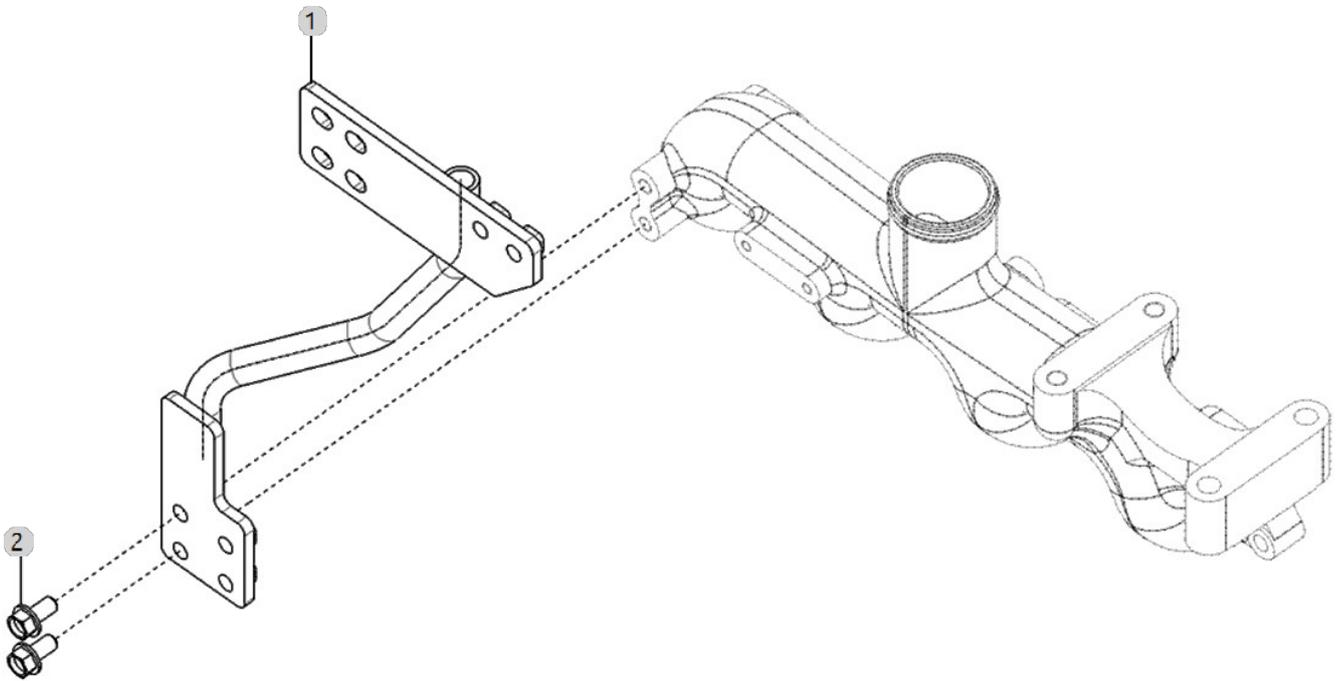



A44\_006

A2300N4-UTR\_4  
(AB00277)

### DPF MOUNTING OPTION

Year/Month

2022-12-19

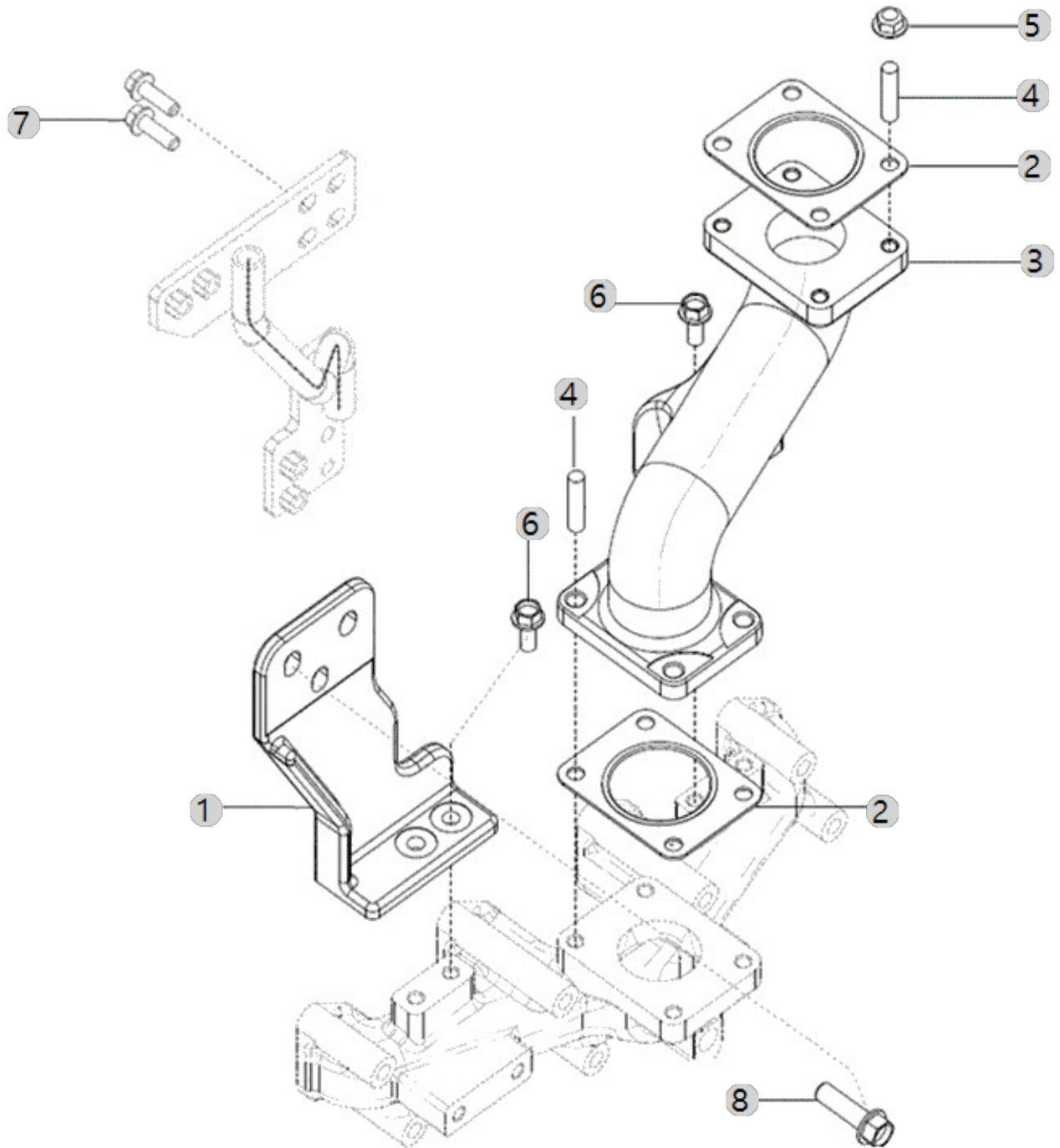



A45\_011

A2300N4-UTR\_4  
(AB00277)

DPF

Year/Month

2022-12-19

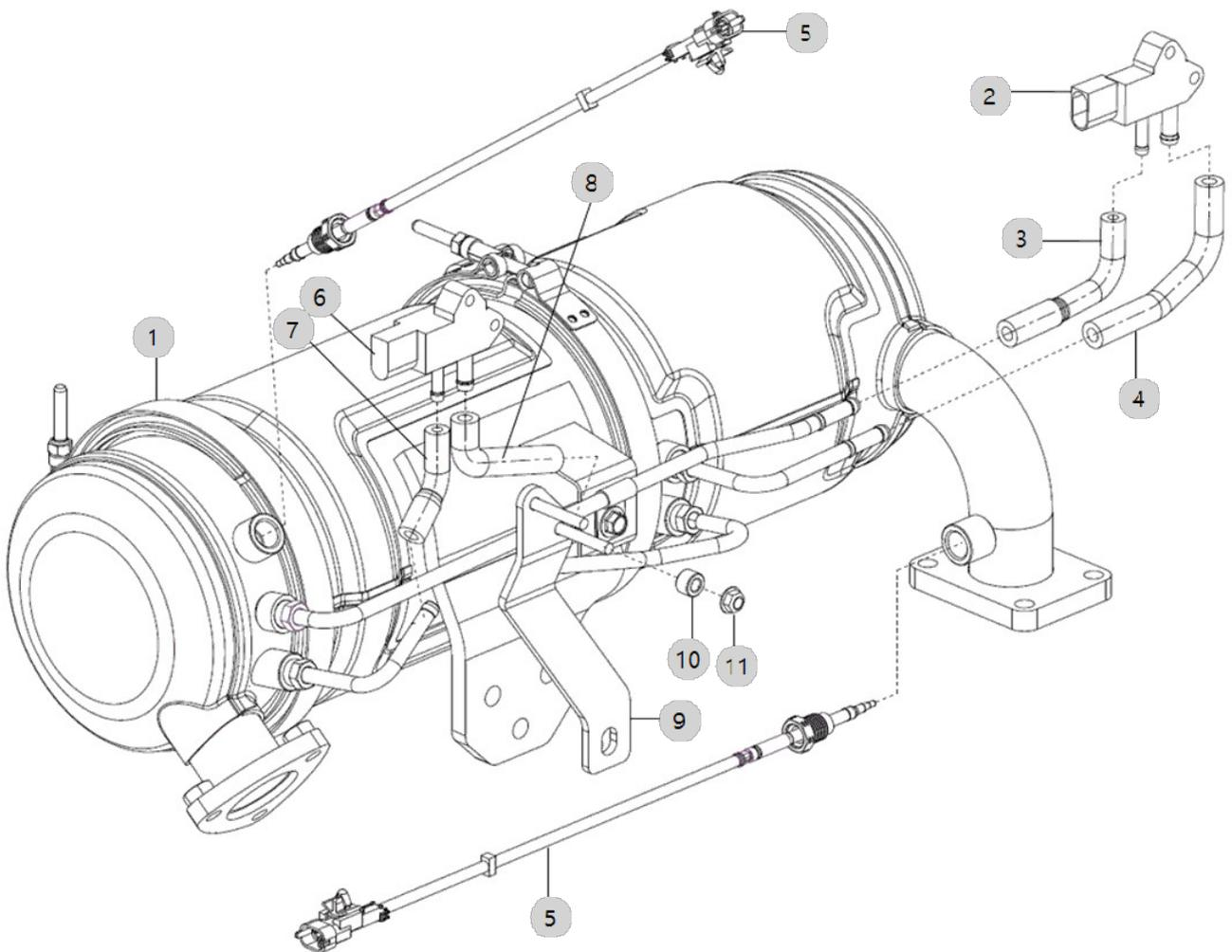



A48\_006

A2300N4-UTR\_4  
(AB00277)

V-BELT

Year/Month

2022-12-19

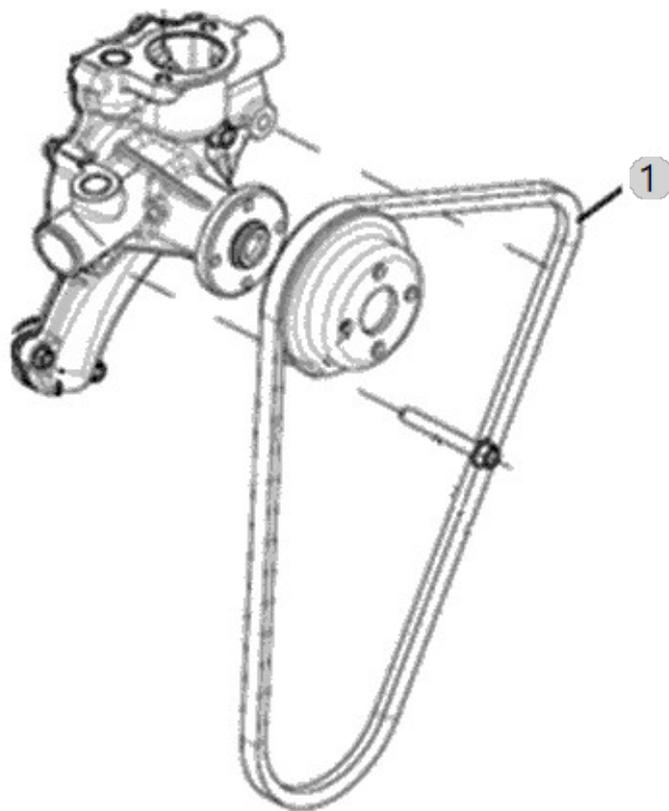





B01010

4815H\_US\_FL  
(AC02166)

# FUEL TANK

Year/Month

2022-12-19

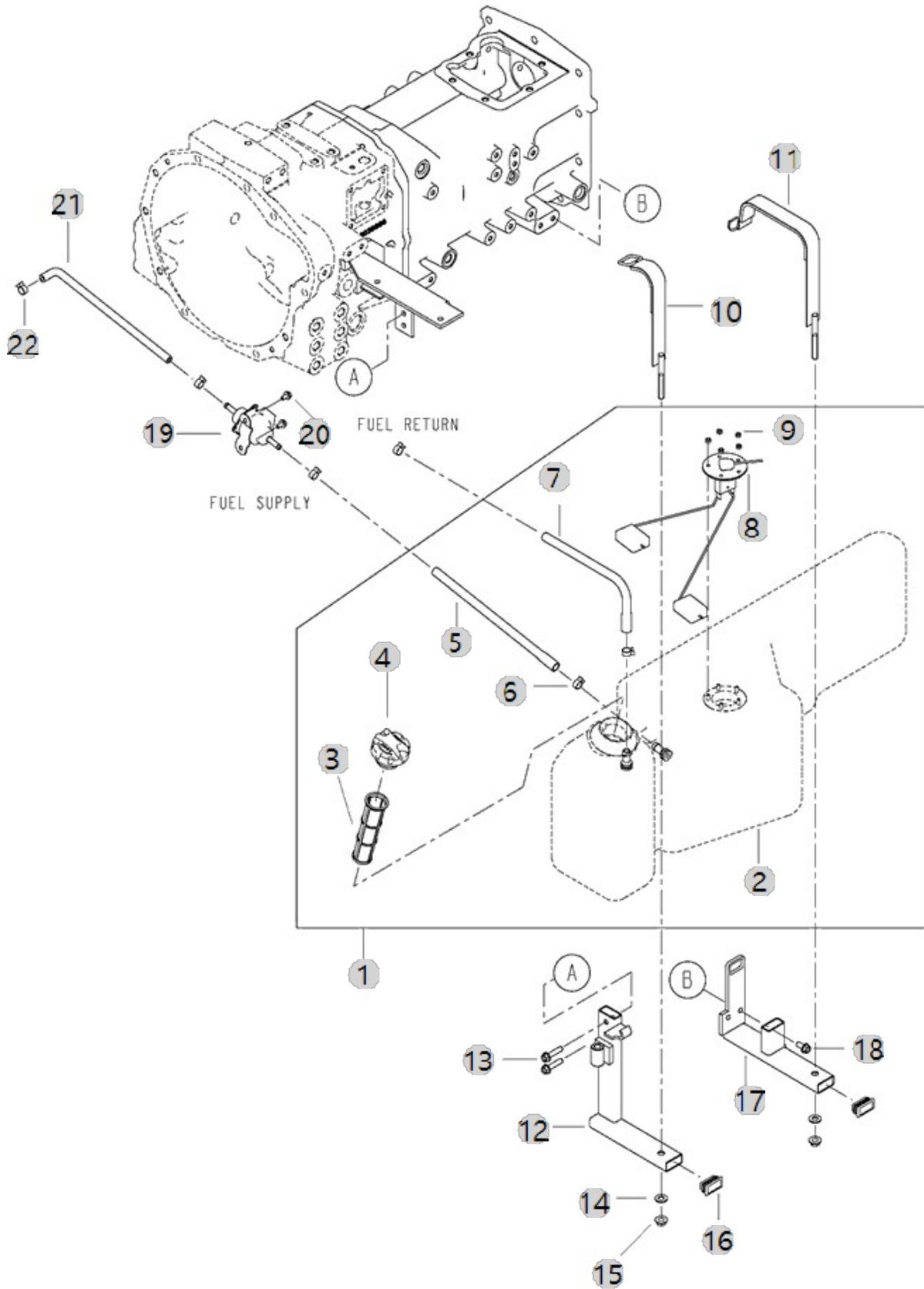



B02020

4815H\_US\_FL  
(AC02166)

# RADIATOR

Year/Month

2022-12-19

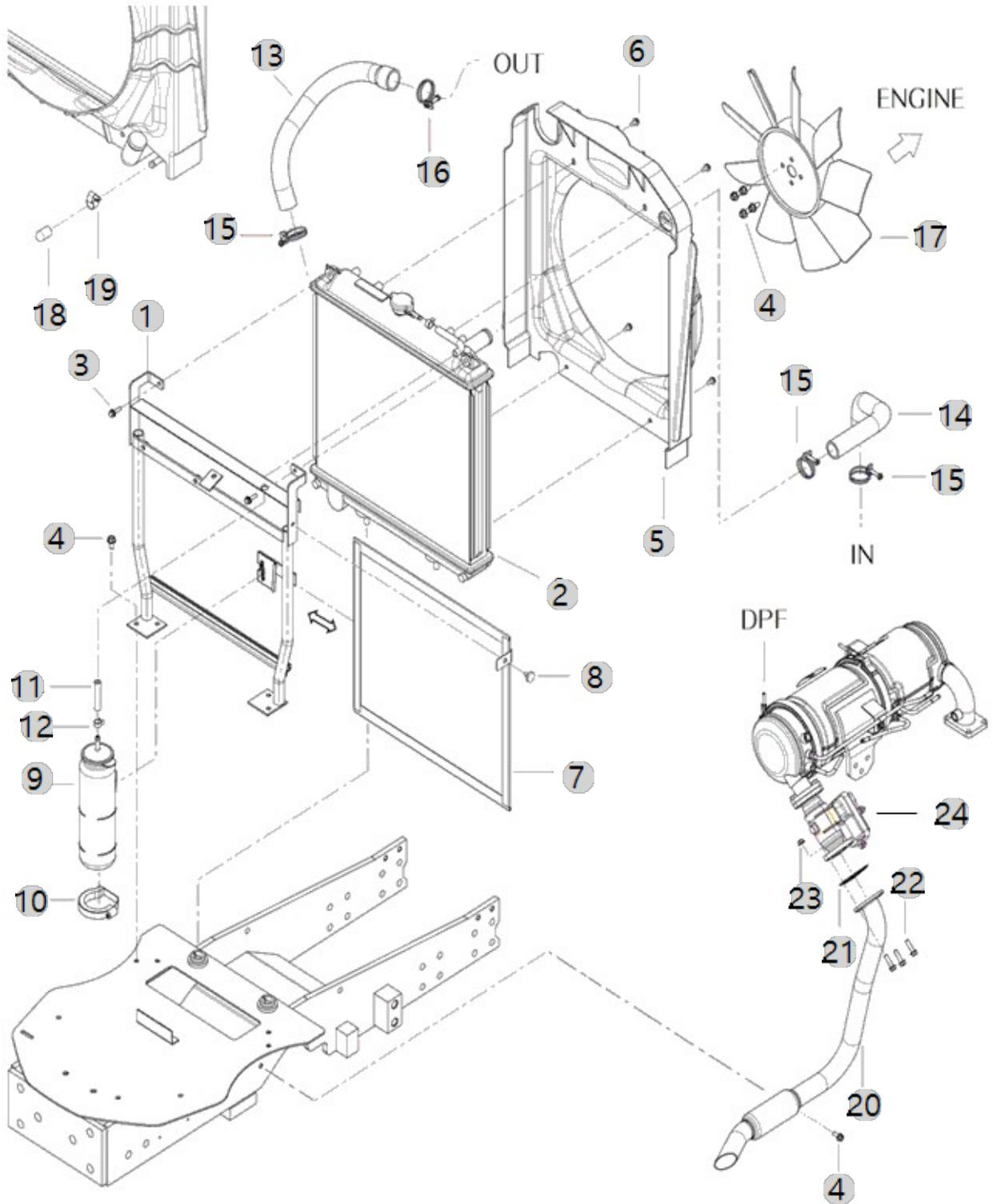

B02020 4815H_US_FL (AC02166)		RADIATOR				Year/Month 2022-12-19
순번 (NO)	부품번호 (PART NO)	품명 (PART NAME)	품명 (PART NAME)	수량 (QTY)	규격 (SPEC)	비고 (REMARK)
1	TA00042694E	라디에이터 브래킷조합(HST)	RADIATOR BRACKET ASS'Y, HST	1		
1B	TA00054746B	라디에이터브래킷조합(H)	RADIATOR BRACKET ASS'Y, H	1		
1A	TA00042694D	라디에이터 브래킷조합(HST)	RADIATOR BRACKET ASS'Y, HST	1		
1	TA00054746A	라디에이터브래킷조합(H)	RADIATOR BRACKET ASS'Y	1		
1	TA00054746C	라디에이터브래킷조합(H)	RADIATOR BRACKET ASS'Y, H	1		
1	TA00042694C	라디에이터 브래킷조합(HST)	BRACKET ASSY	1		
2	HRE1203000B1	라디에이터조합	RADIATORASSY	1		
2	HRA1203000B1	라디에이터조합	RADIATOR ASSY	1		
3	26014-060252	와셔조립육각볼트(+SW,PW)	Bolt, Hexa (6-25)	2	M06X1.00X02	
4	26106-080162	플랜지볼트8X16	SCREW,HEXFLANGEHEADCAP	9	M8XP1.25X16	
5	TA00040421C	슈라우드	SHROUD	1		
6	HRA1203200A4	태핑나사	TAPPINGSCREW	4		
7	TA00053642B	방진망조합	DUSTPROOF MESH ASS'Y	1		
7	TA00040713D	방진망조합	NET, ASS'Y	1		
8	CA00009493A	고정나사(검정)	FIX BOLT (BLACK)	1		
9	CA09270000C2	보조탱크조합	COOLANT RESERVOIR	1		
10	CA09310000A4	보조탱크부착밴드	STRAP,SUBTANKMTG	1		
11	23980-730280	플루우트호스	FLOAT_HOSE	1		
11	23980-730330	플루우트호스	HOSE	1		
12	23080-013000	호스 클립	Clamp, Hose (Φ13)	1	D13	
13	TA00049957B	냉각수 호스B	COOLING WATER HOSE B	1		
13	TA00039707B	냉각수 호스 B	HOSE B	1		
14	TA00060737A	냉각수 호스 A	HOSE A	1		
14	TA00060726A	냉각수호스A	COOLING WATER HOSE A	1		
15	23010-038000	호스밴드	HOSEBAND	3	D38	
16	23010-040000	호스밴드40	HOSEBAND	1	D40	
17	TA00044911A	냉각팬(D385)	COOLING PAN	1		
17C	TA00048457B	냉각팬(D385)	COOLING PAN(D385)	1		
17	HRA1200800A1	냉각팬 AF NF (d=380mm)	COOLING FAN	1		
17	TA00048457A	냉각팬(D385)	FAN, COOLING	1		
18	HRC1201200A4	오일쿨러캡	CAP,COOLER	1		
19	23000-016000	호스클립	Clip, Hose (Φ16)	1	D16	
20	TA00060420A	배기파이프 조합(RESONATOR)	EXHAUST PIPE ASSY(RESONATOR)	1		
20	TA00062518A	배기파이프 조합	EXHAUST PIPE ASS'Y	1		
21	EA00006088A	가스켓(배기밸브)	GASKET, ASSEMBLE TYPE ELECTRONIC EXHAUST VALVE	2	T2.0	
21	HK0514000EA4	개스킷(소음기)	GASKET	1		
22	26106-080302	육각플랜지볼트	HEX BOLT, FLANGE	3	M8XP1.25X30	
23	26367-080002	259, 육각플랜지너트	HEX FLANGE NUT (Φ8)	3	M8XP1.25	
24	EA00005795B	전자식배기밸브ASS'Y(조립식)	ELECTRONIC EXHAUST VALVE ASS'Y (ASSEMBLE TYPE)	1		
24	EA00005795C	전자식배기밸브ASS'Y(조립식)	ELECTRONIC EXHAUST VALVE ASS'Y (ASSEMBLE TYPE)	1		

B03010

4815H\_US\_FL  
(AC02166)

# AIR CLEANER

Year/Month

2022-12-19

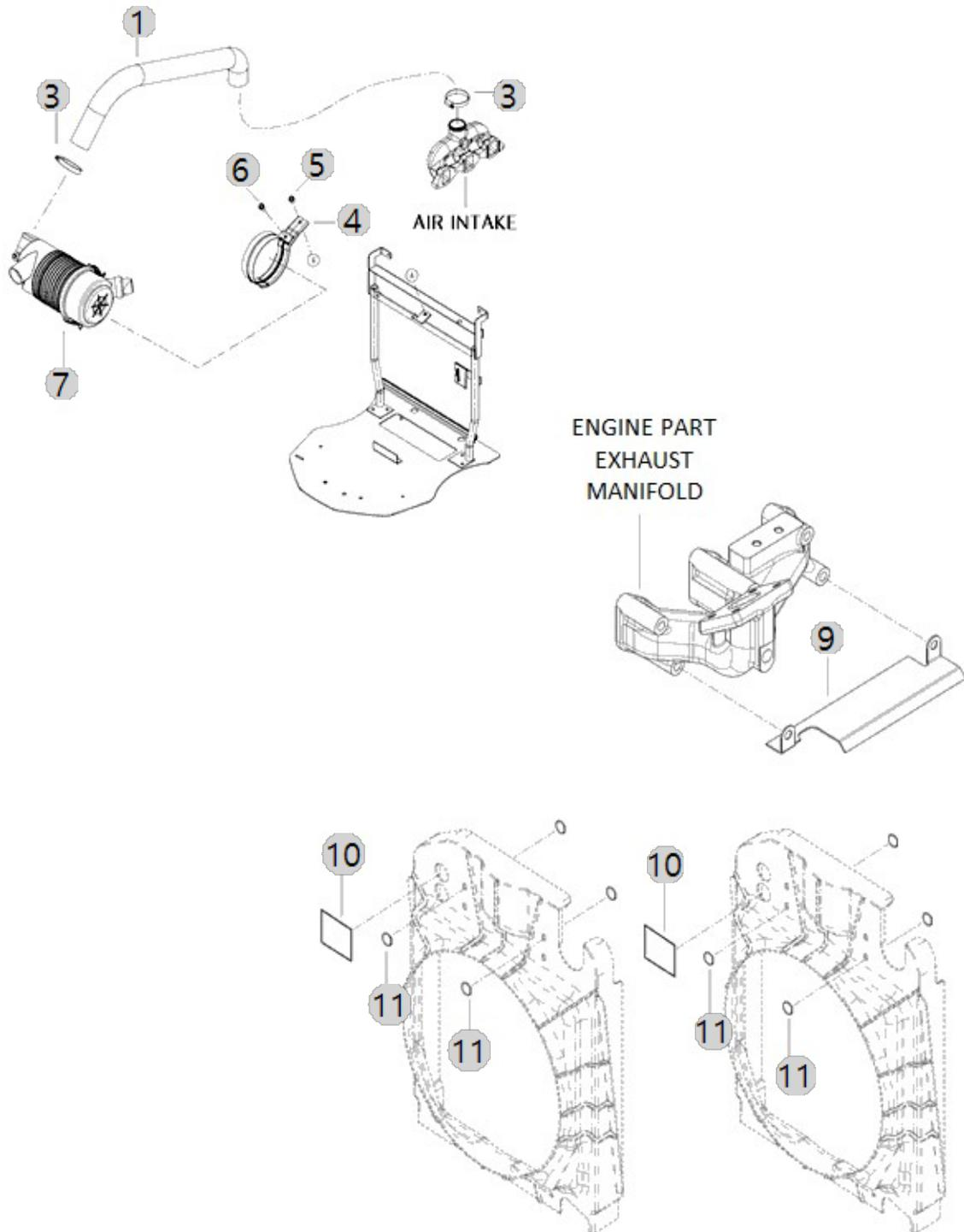



B05011

4815H\_US\_FL  
(AC02166)

# LEVER ACCELERATOR

Year/Month

2022-12-19

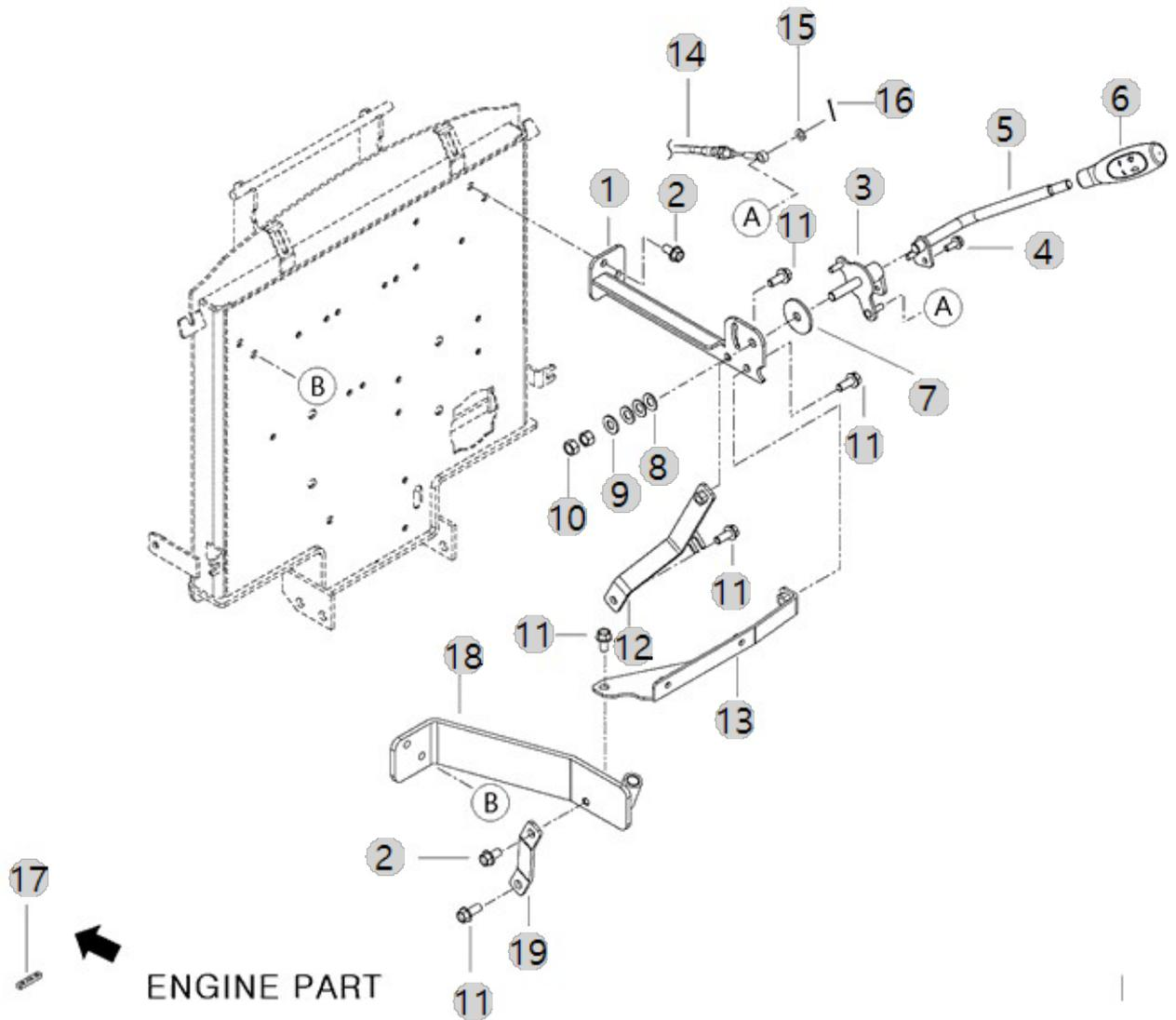





C02010

4815H\_US\_FL  
(AC02166)

# BRAKE PEDAL

Year/Month

2022-12-19

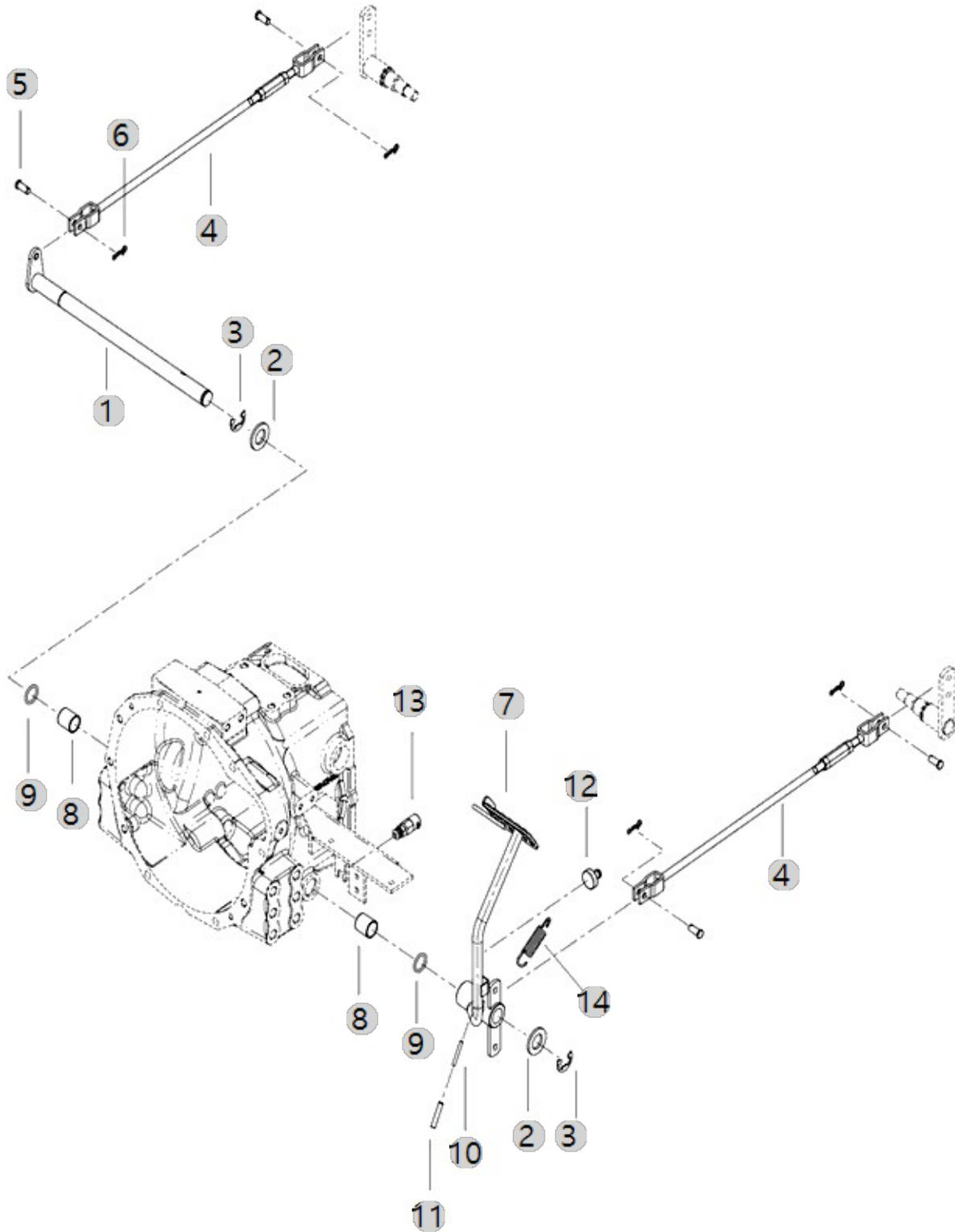



C02050

4815H\_US\_FL  
(AC02166)

# PARKING BRAKE

Year/Month

2022-12-19

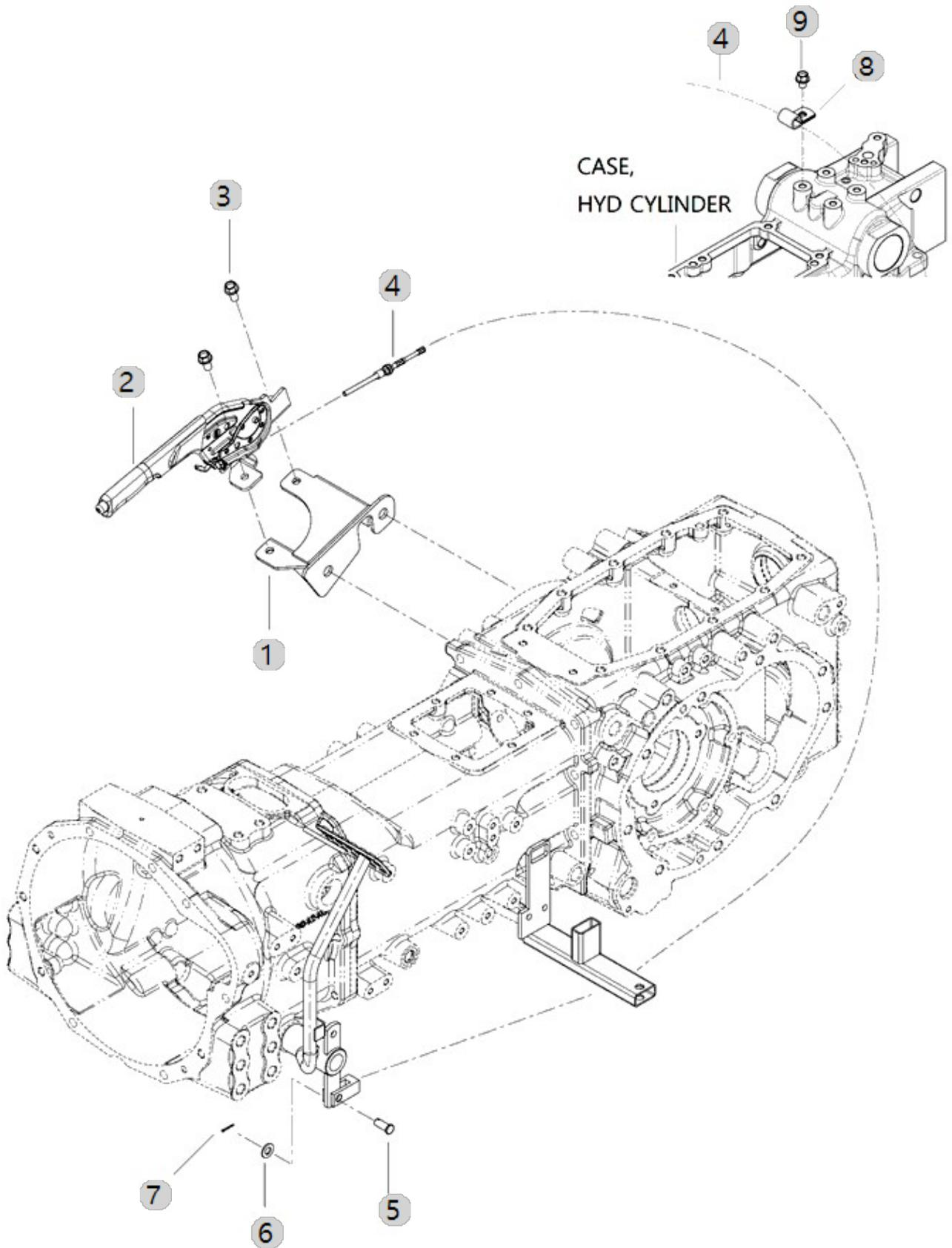



C03010

4815H\_US\_FL  
(AC02166)

### HYD SHIFT TRANSMISSION PEDAL

Year/Month

2022-12-19

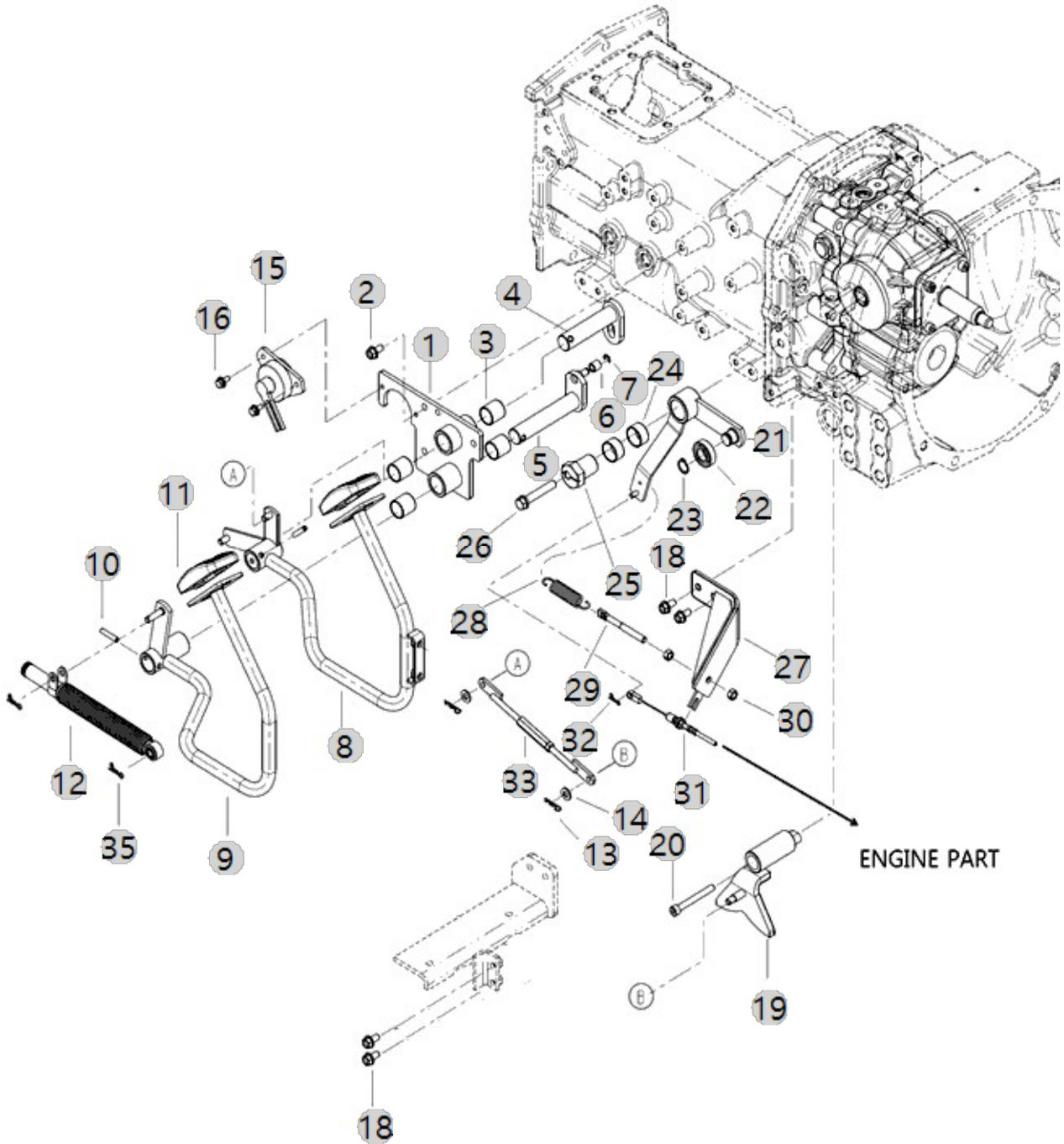



D01010-B

4815H\_US\_FL  
(AC02166)

HYD PUMP

Year/Month

2022-12-19

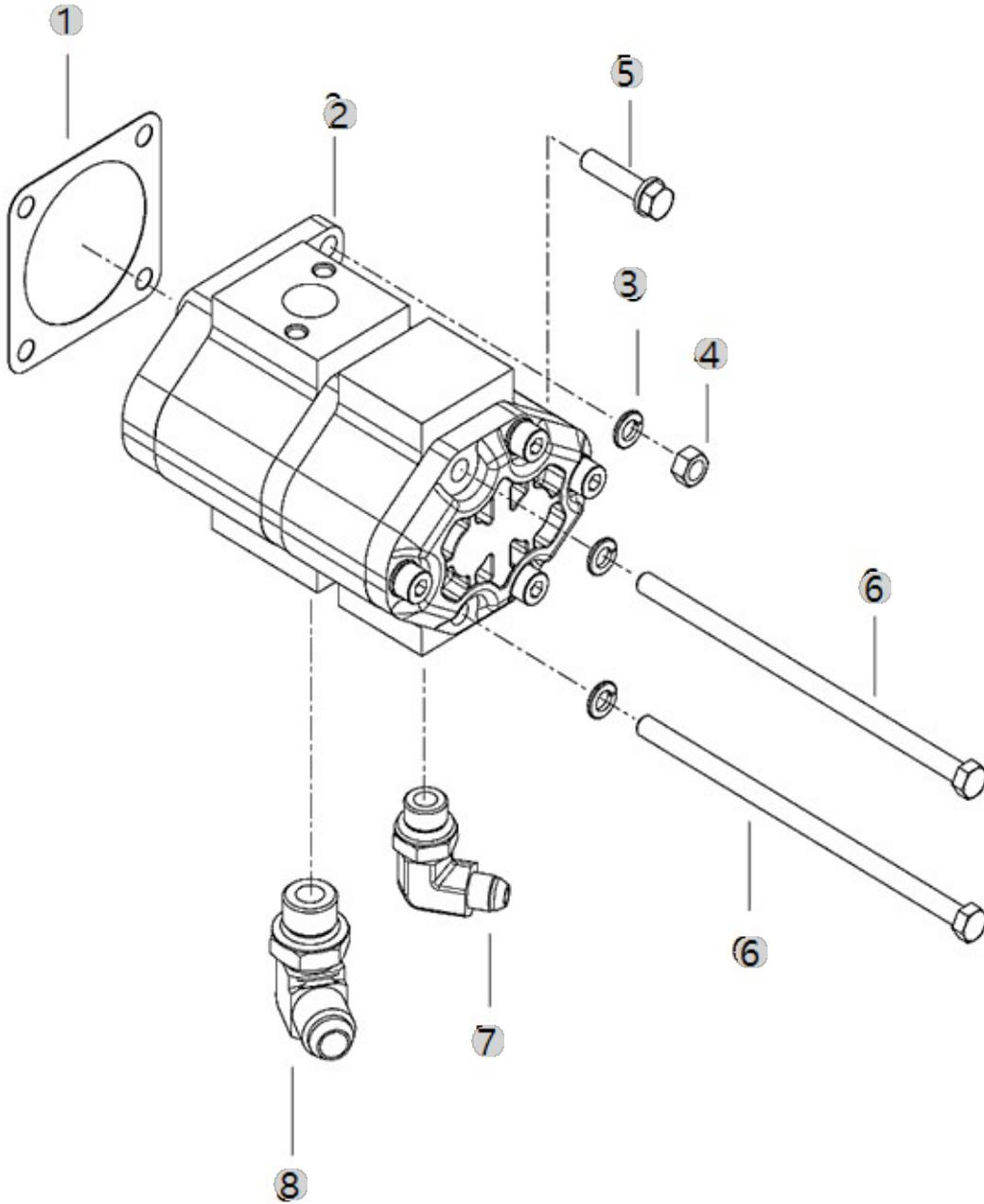





D01020-B

4815H\_US\_FL  
(AC02166)

LOW PRESSURE PIPE

Year/Month

2022-12-19

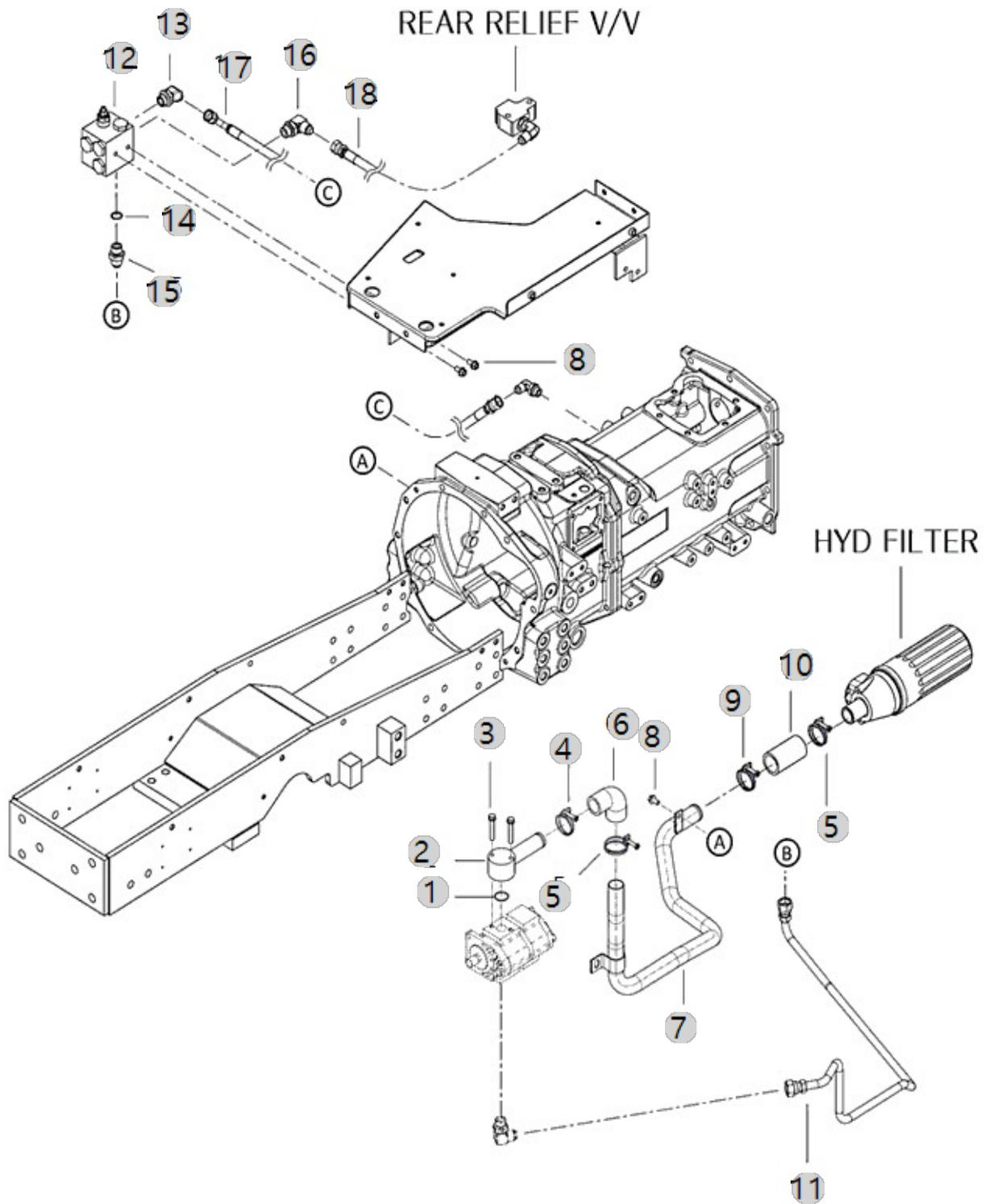



D01040

4815H\_US\_FL  
(AC02166)

# HYD FILTER

Year/Month

2022-12-19

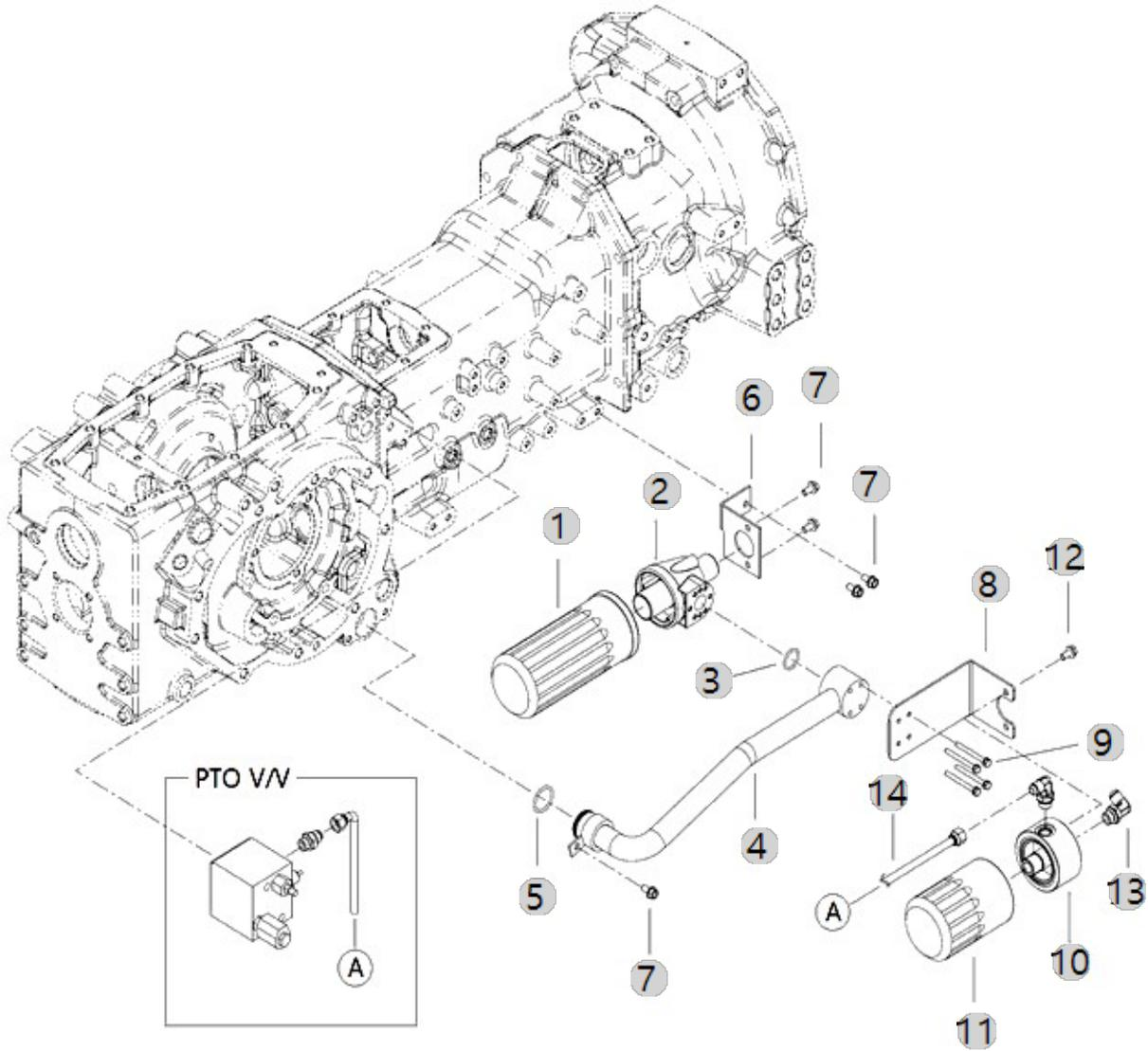



D02010

4815H\_US\_FL  
(AC02166)

# STEERING COLUMN

Year/Month

2022-12-19

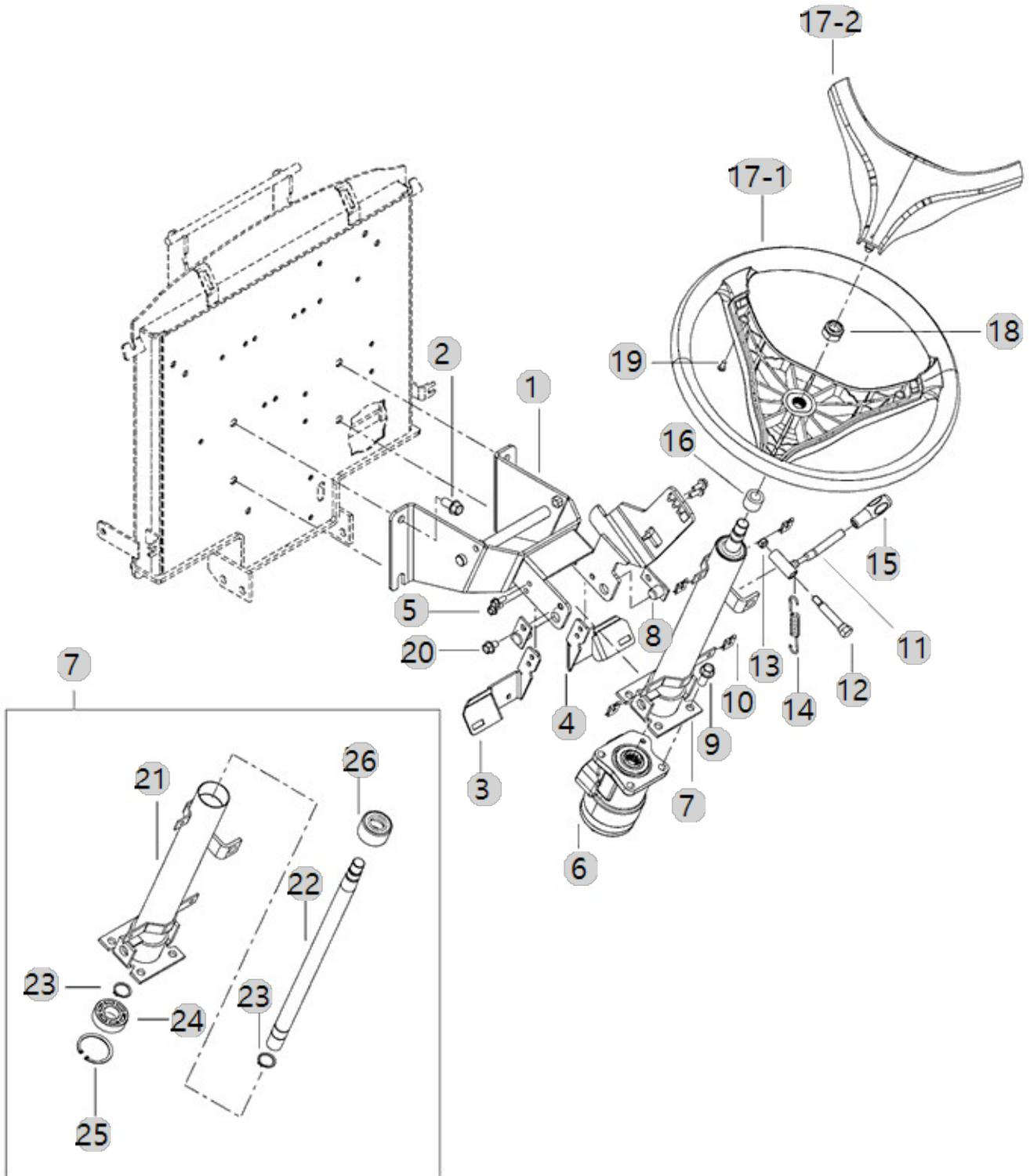



D02030

4815H\_US\_FL  
(AC02166)

P.S.T HOSE

Year/Month

2022-12-19

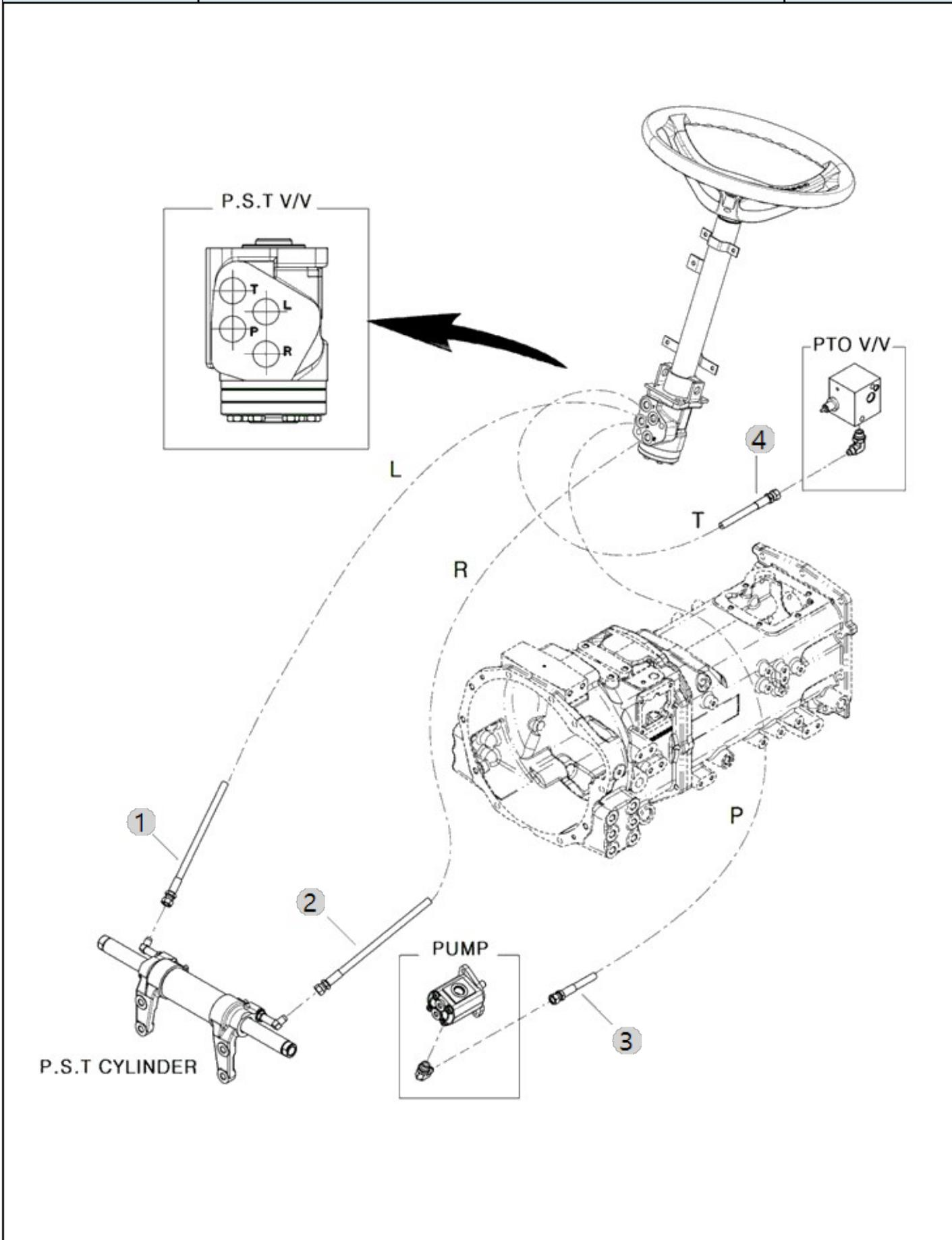





D02040

4815H\_US\_FL  
(AC02166)

P.S.T CYLINDER

Year/Month

2022-12-19

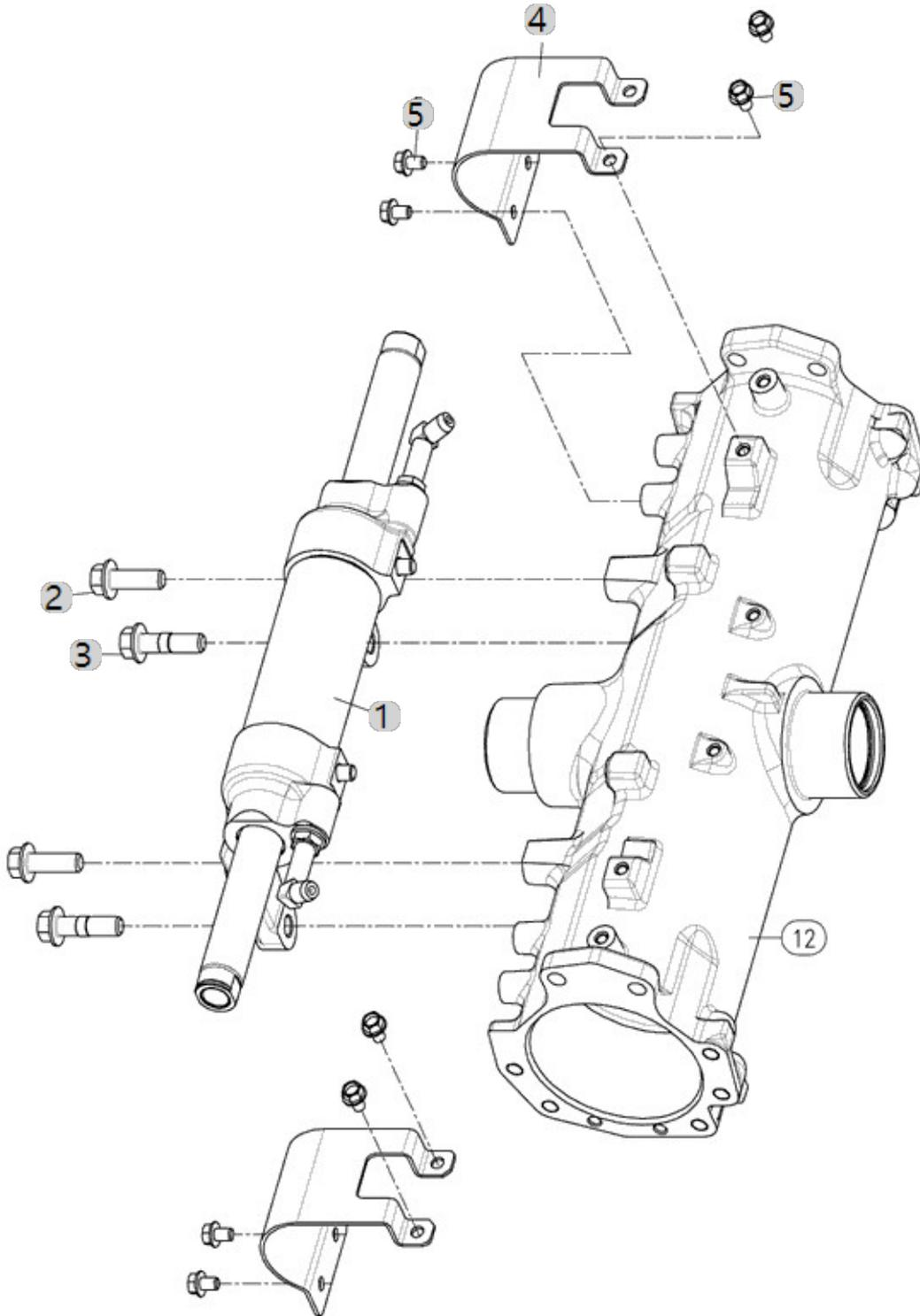



D03010

4815H\_US\_FL  
(AC02166)

OIL COOLER

Year/Month

2022-12-19

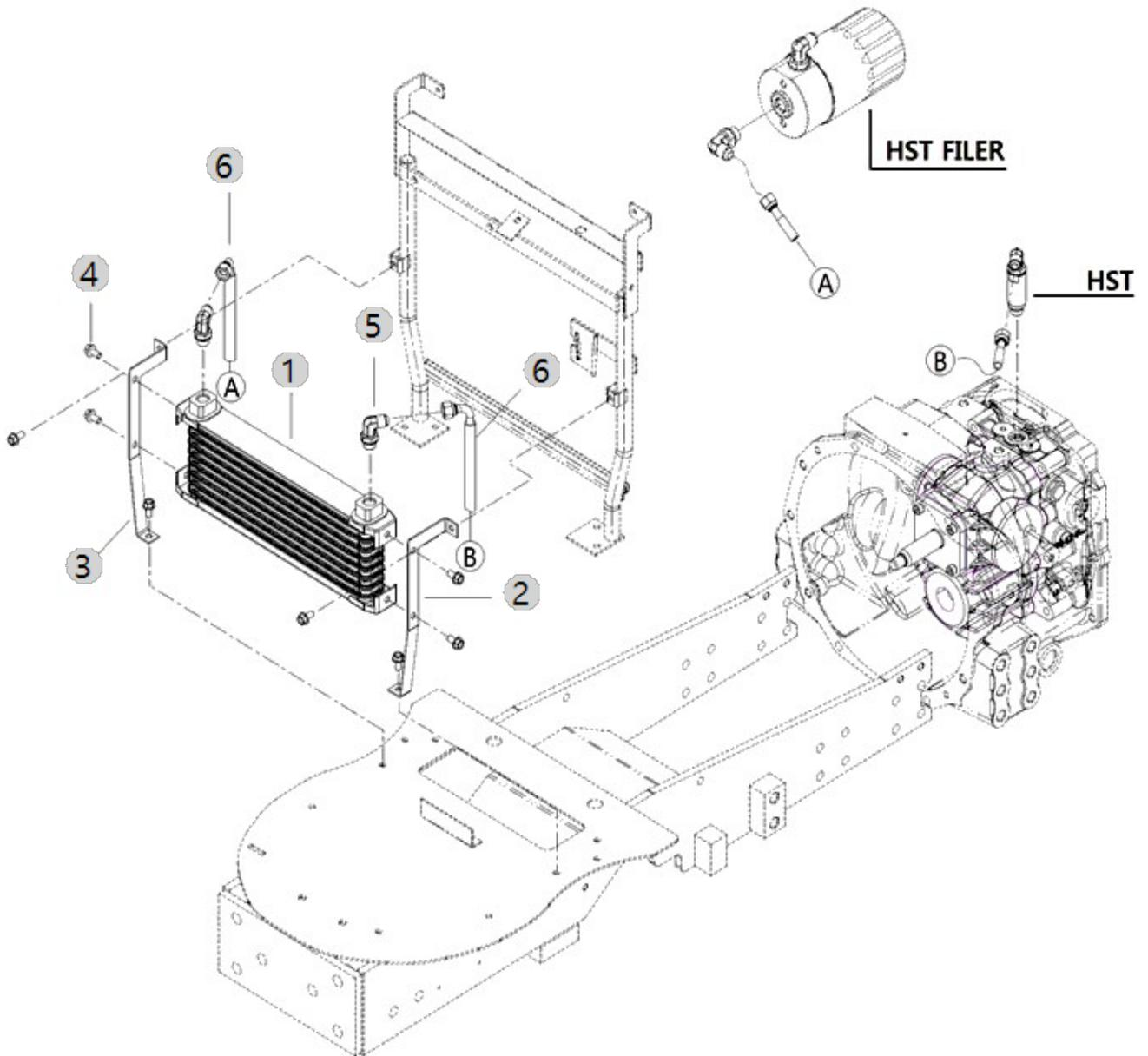



E01010

4815H\_US\_FL  
(AC02166)

# FRONT AXLE CASE

Year/Month

2022-12-19

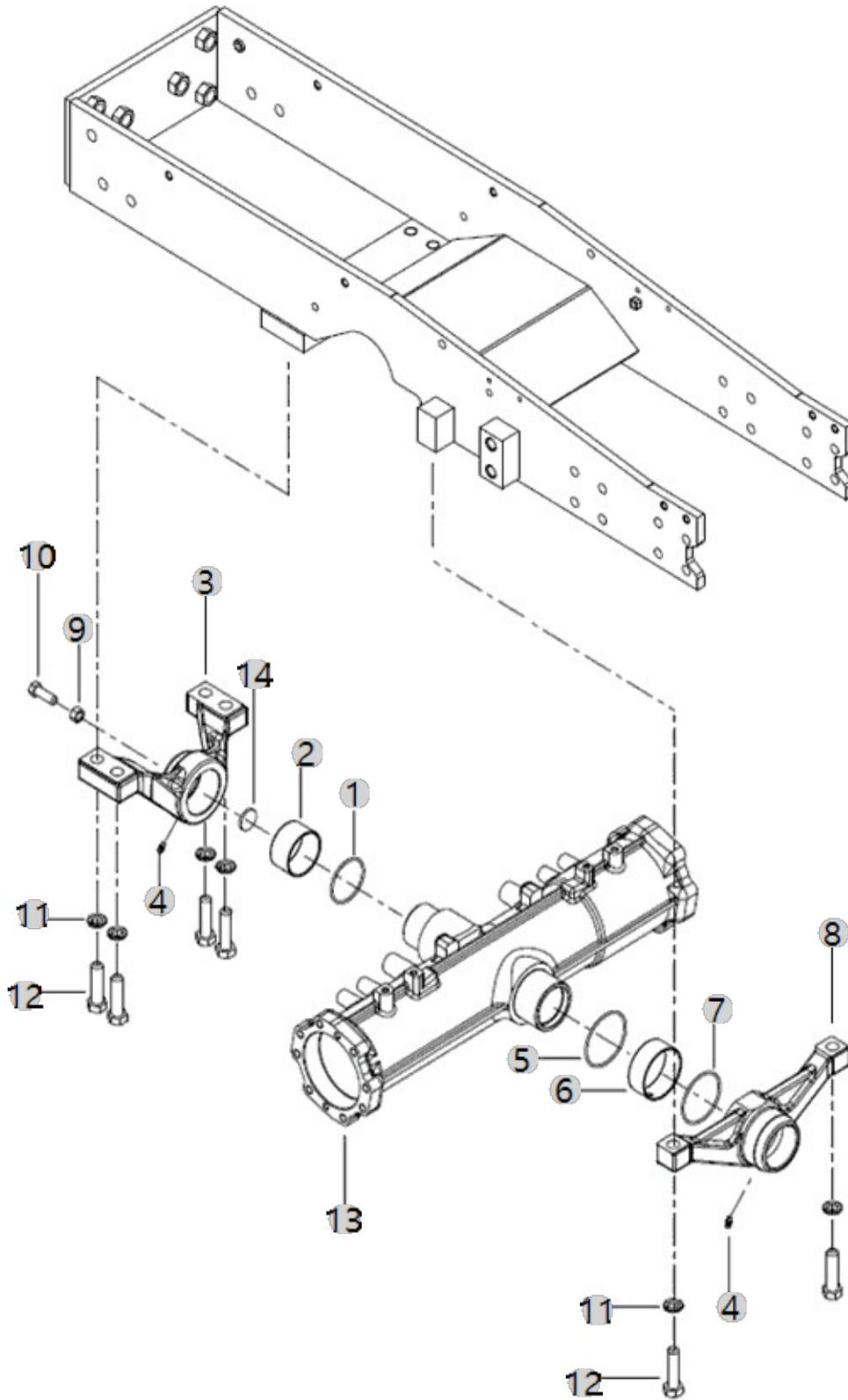



E01013

4815H\_US\_FL  
(AC02166)

SPACER

Year/Month

2022-12-19

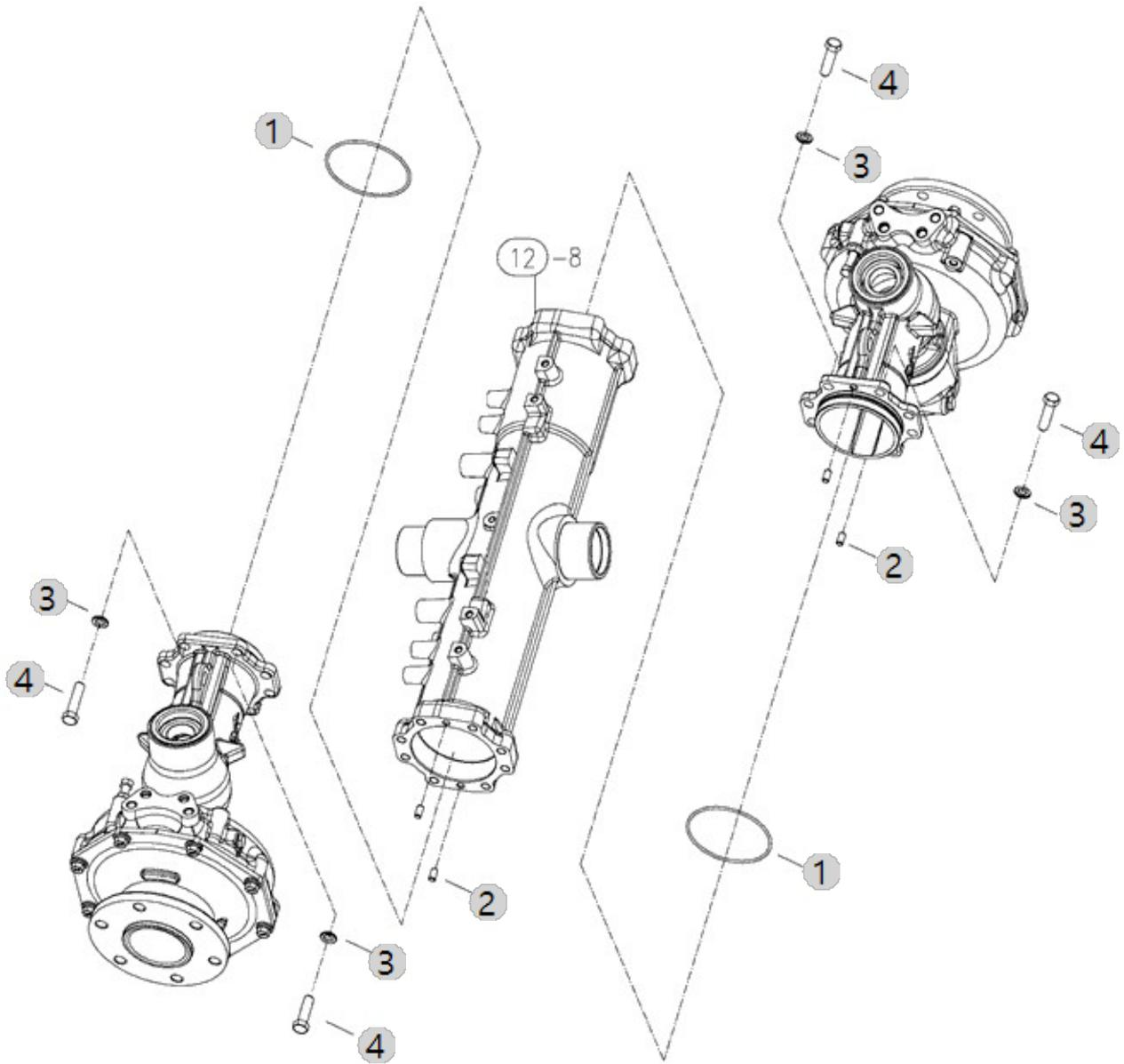





E01030

4815H\_US\_FL  
(AC02166)

### GEAR CASE, FRONT AXLE

Year/Month

2022-12-19

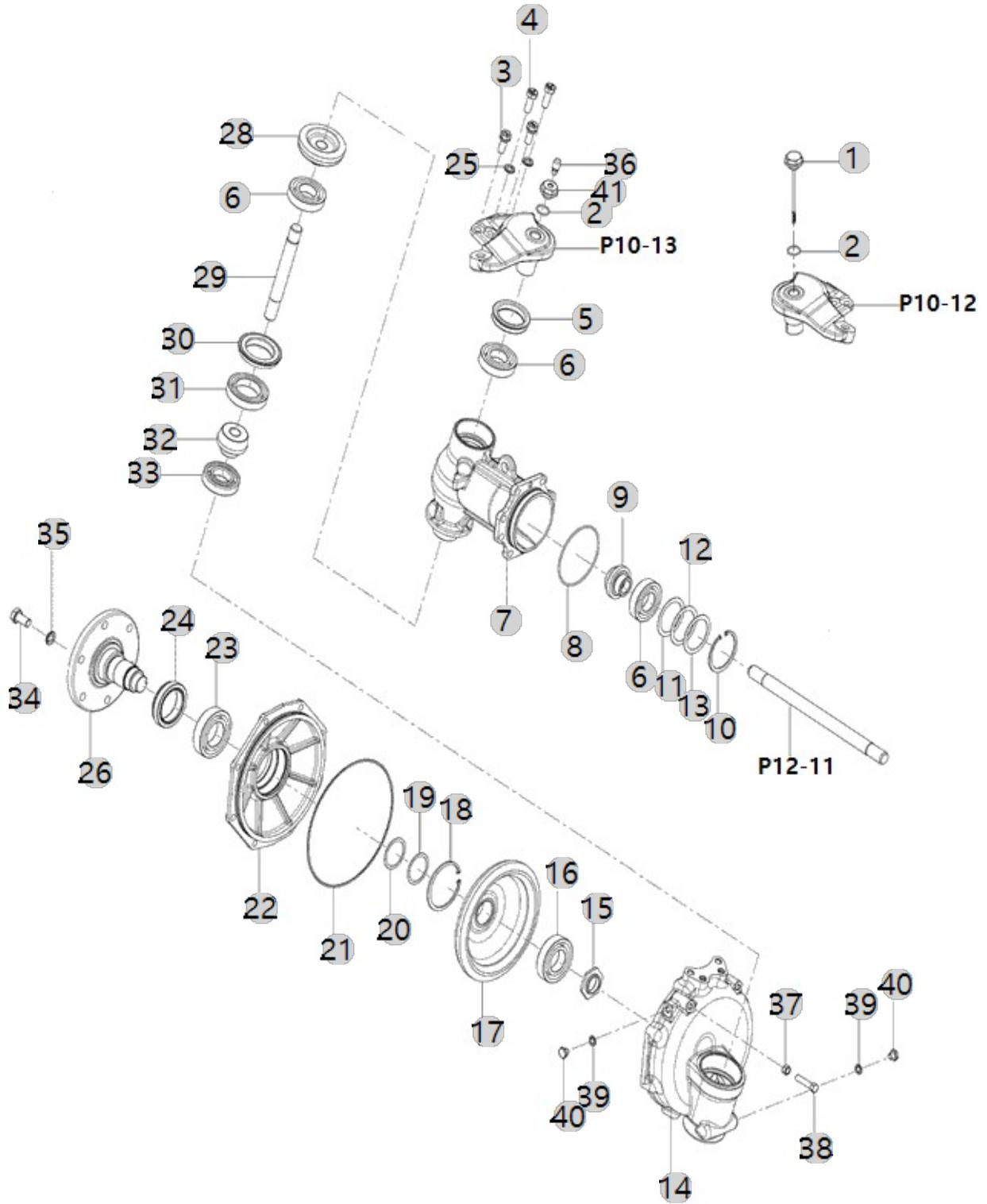

E01030 4815H_US_FL (AC02166)		GEAR CASE, FRONT AXLE				Year/Month 2022-12-19
순번 (NO)	부품번호 (PART NO)	품명 (PART NAME)	품명 (PART NAME)	수량 (QTY)	규격 (SPEC)	비고 (REMARK)
1	TA00033805A	검유봉	OIL GUAGE	1		
2	24311-000220	O-RING1AP-22.0	O-RING, DYNAMIC (Φ22)	2	1A P22.0	
3	TA00033468C	와셔조립육각볼트	BOLT W/ WASHER	4		
4	TA00033475B	리머볼트	SPACER	4		
5	FE78010000B	오일실 (특수) 55x72x13.5	OIL SEAL (55X72X13.5)	2	55X72X13.5	
6	24101-062074	볼베어링6207	BALL BEARING (#6207)	6	#6207	
7	TA00033457C	프런트기어케이스	CASE, FRONT GEAR	2		
8	24321-001050	O-링	O-RING	2		
9	TA00033461B	전1축피니언9T	PINION, FRONT 1ST SHAFT	2		
10	22252-000720	구멍용스냅링72	RING, CIRCLIP (Φ 72)	2	D72	
11	TA00033489A	심 0.2T	SHIM 0.2T	2		
12	TA00033488A	심 0.3T	SHIM 0.3T	2		
13	TA00033487A	심 0.5T	SHIM 0.5T	2		
14	TA00033458C	프런트기어박스	GEAR BOX, FRONT	2		
15	TA00033481A	로크너트	LOCK NUT	2		
16	24101-062084	볼베어링6208	Bearing, Ball (#6208)	2	#6208	
17	TA00033474A	베벨기어 49T	GEAR, BEVEL 49T	2		
18	22252-000850	써클립85H	RING, CIRCLIP (Φ 85)	2		
19	TA00033486A	심 0.2T	SHIM 0.2T	1		
20	TA00033485A	심 0.5T	SHIM 0.5T	1		
21	TA00033939A	O링	O RING	2		
22	TA00033459C	프런트베어링케이스	BEARING CASE, FRONT	1		
23	24101-062094	볼베어링6209	BALL BEARING (#6209)	2	#6209	
24	TA00041359A	오일실	OILSEAL	2		
25	22217-120000	스프링와셔	WASHER, SPRING (Φ 12)	2	M12	
26	TA00033460C	프런트스핀들	SPINDLE, FRONT	2		
26	TA00033460E	프런트스핀들	SPINDLE, FRONT	2		
26	TA00033460D	프런트스핀들	SPINDLE, FRONT	2		
27	TA00033469B	와셔조립육각볼트	BOLT W/ WASHER	16		
28	TA00033463A	전2축기어	FRONT 2ND AXLE LH	2		
29	TA00033464A	전2축	FRONT 2ND SHAFT	2		
30	TC60110000A3	오일실(AJ)	SEAL, OIL	2		
31	24101-060104	볼베어링6010	Bearing, Ball (#6010)	2	#6010	
32	TA00033473A	베벨기어 11T	GEAR, BEVEL 11T	2		
33	TC60340000A4	베어링TM207C3	BEARING(TM207C3)	2	TM207C3	
34	TD23120000B4	프런트 허브 볼트(M14X28)	BOLT	12	M14XP1.5	
35	22217-140000	스프링와셔14	WASHER, SPRING (Φ 14)	12	M14	
36	TA00049842A	에어브리더(STEEL)	AIR BREATHER	1		
36	TA00049842B	에어브리더(STEEL)	AIR BREATHER	1		
37	26716-100001	육각너트	NUT	2		
38	26112-100452	육각볼트	BOLT	2		
39	22190-100000	실와셔	WASHER	4	M10	
40	23887-100002	플러그(미터)	SCREW,HEXAGONHEADCAP	4	M10	
41	TA00049843B	에어브리더 플러그	ADAPThER	1		





E01080

4815H\_US\_FL  
(AC02166)

TIE ROD

Year/Month

2022-12-19

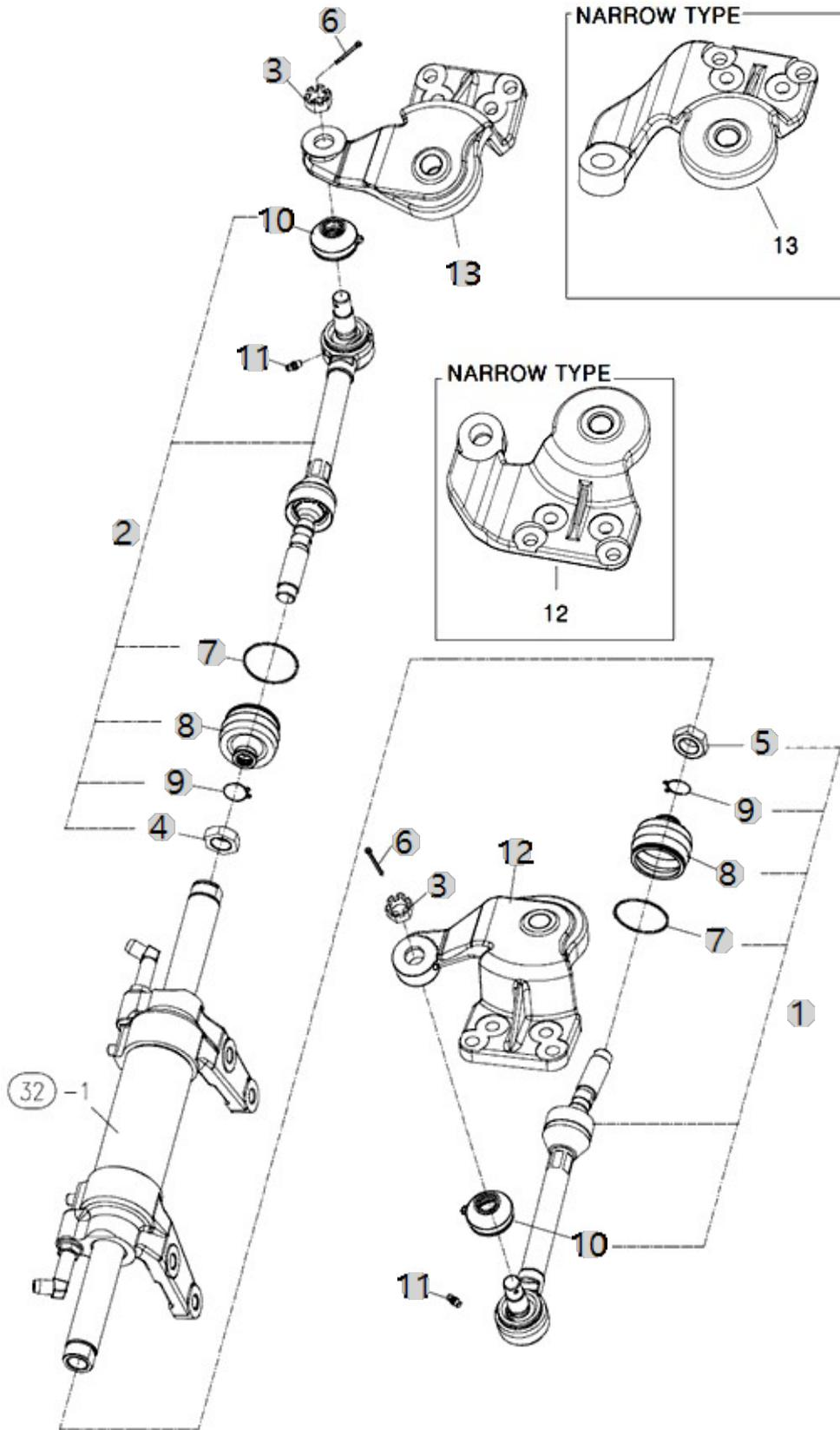



F01010-B

BRANSON 15H  
TM\_US\_FL(AC01917)

# CLUTCH HOUSING

Year/Month

2022-12-19

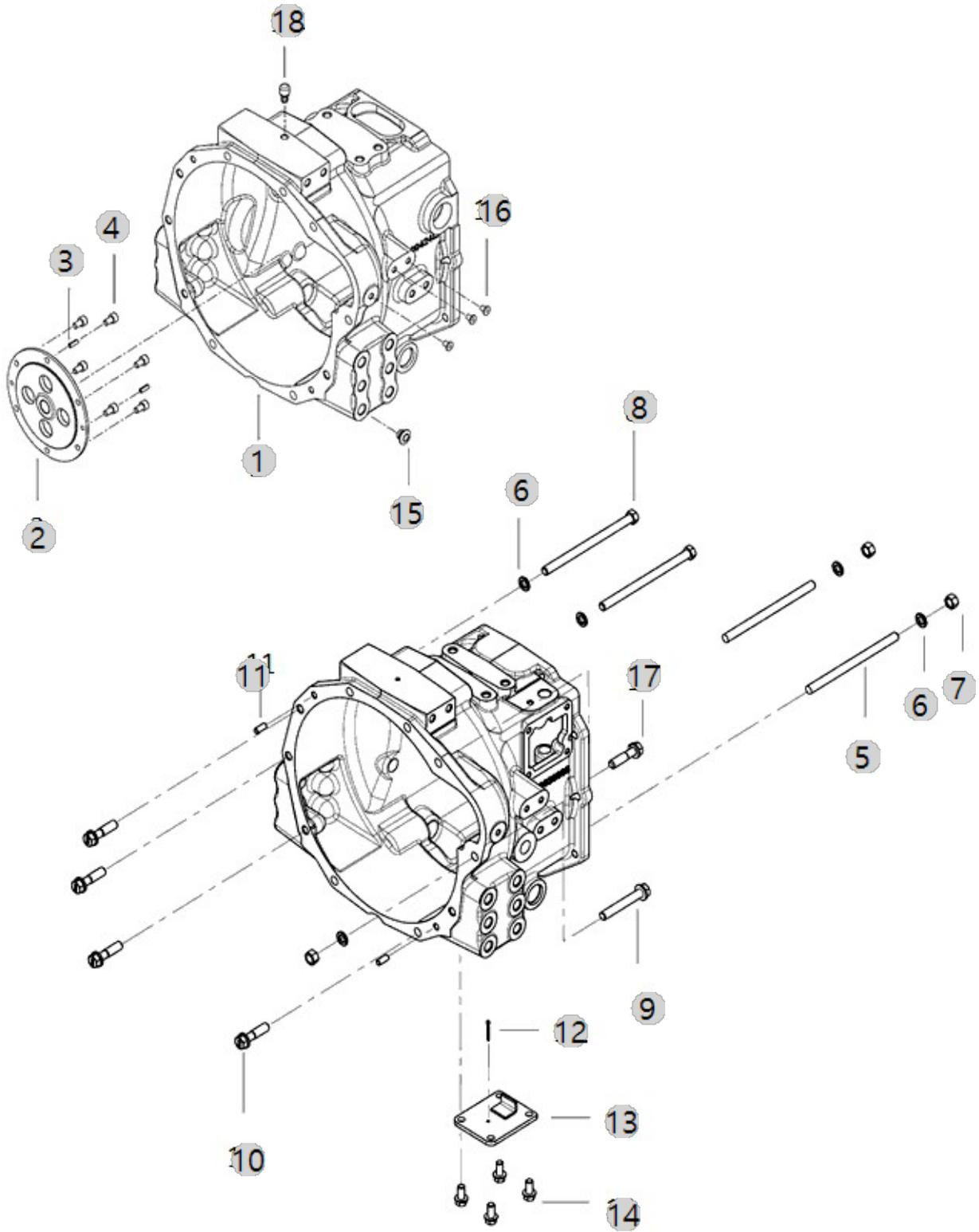





F01020

BRANSON 15H  
TM\_US\_FL(AC01917)

# TRANSMISSION CASE

Year/Month

2022-12-19

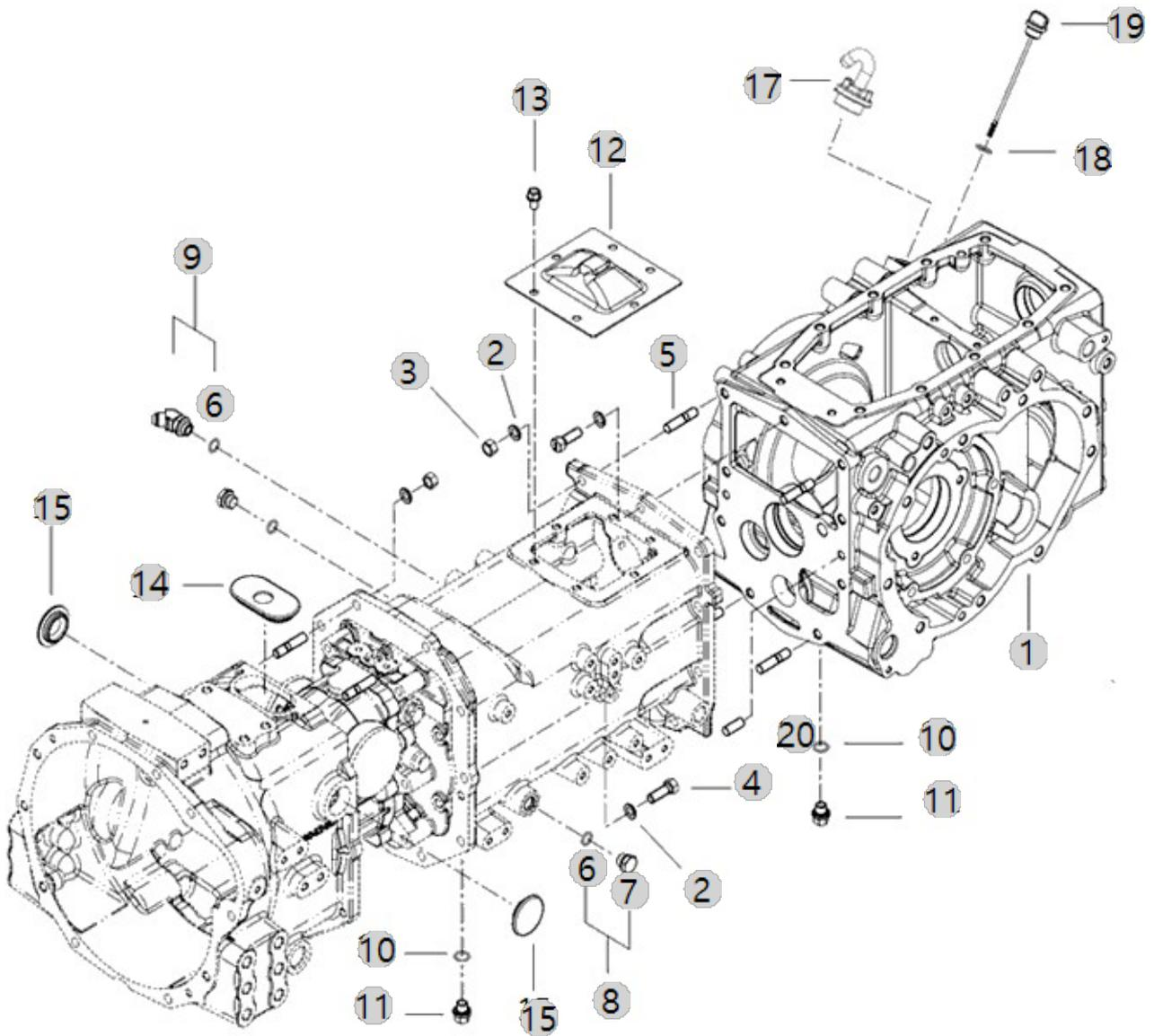



F01030

BRANSON 15H  
TM\_US\_FL(AC01917)

REAR AXLE HOUSING

Year/Month

2022-12-19

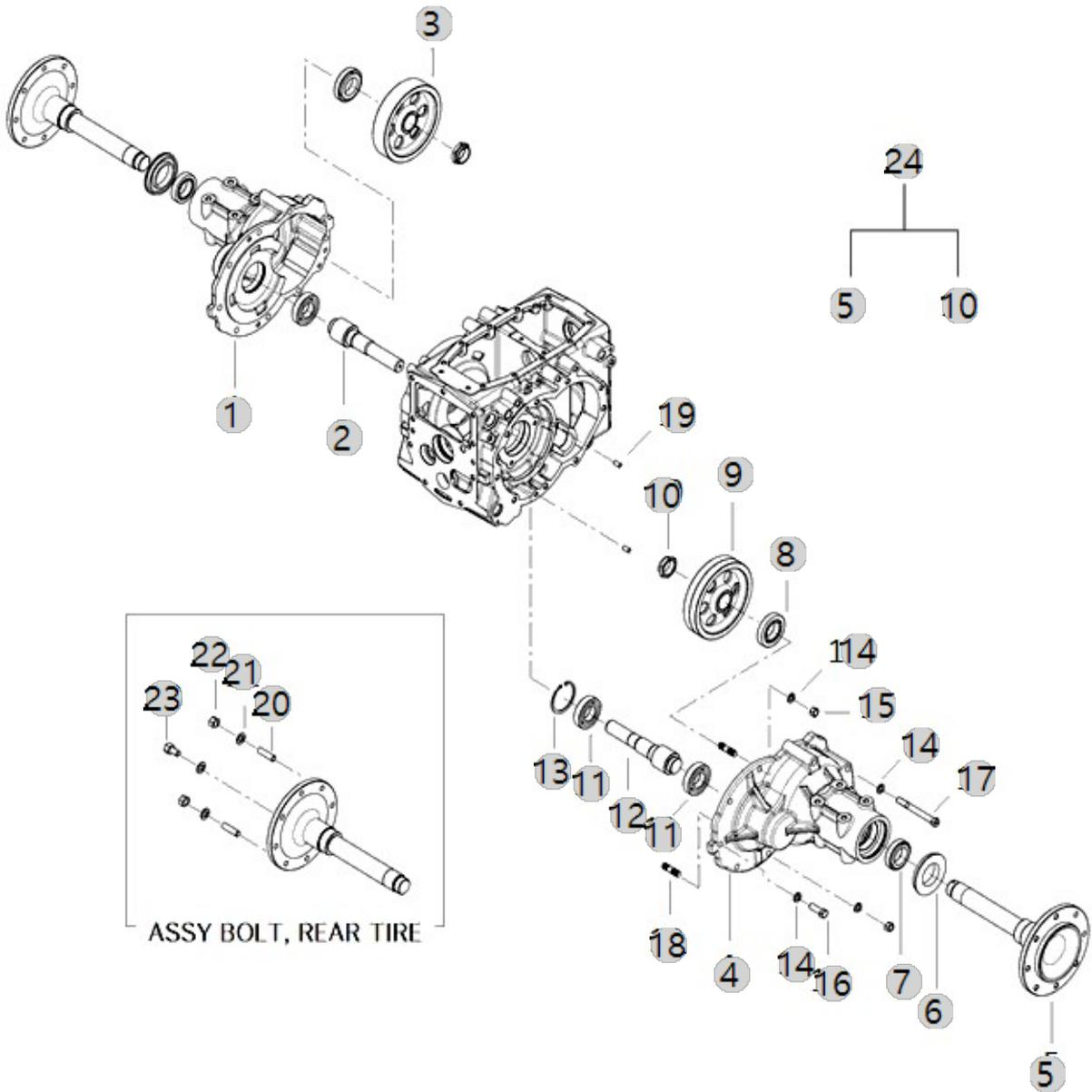



F01050

BRANSON 15H  
TM\_US\_FL(AC01917)

HYD SHIFT TRANSMISSION HOUSING

Year/Month

2022-12-19

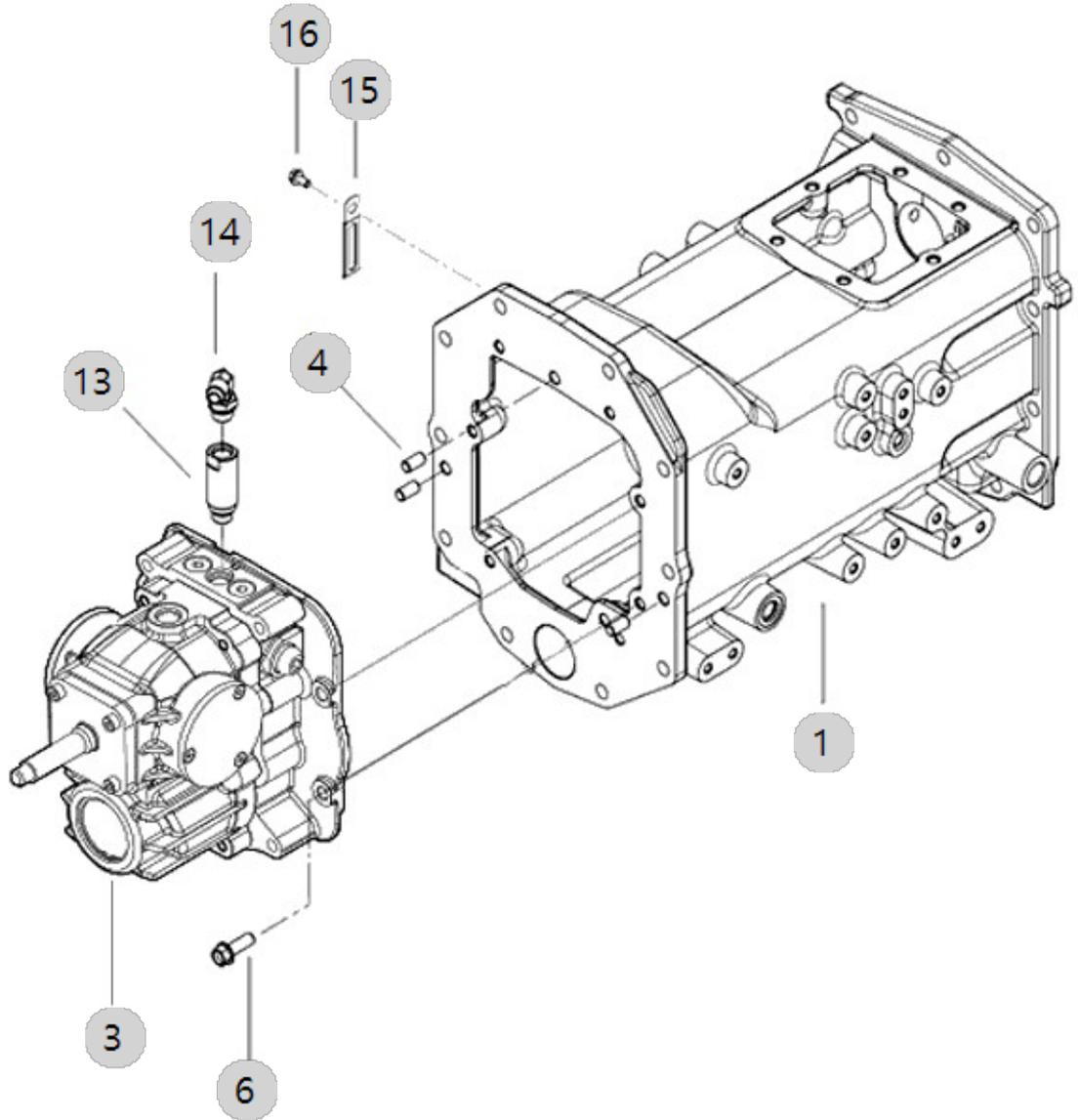



F03040

BRANSON 15H  
TM\_US\_FL(AC01917)

### RANGE SHIFT DRIVE SHAFT

Year/Month

2022-12-19

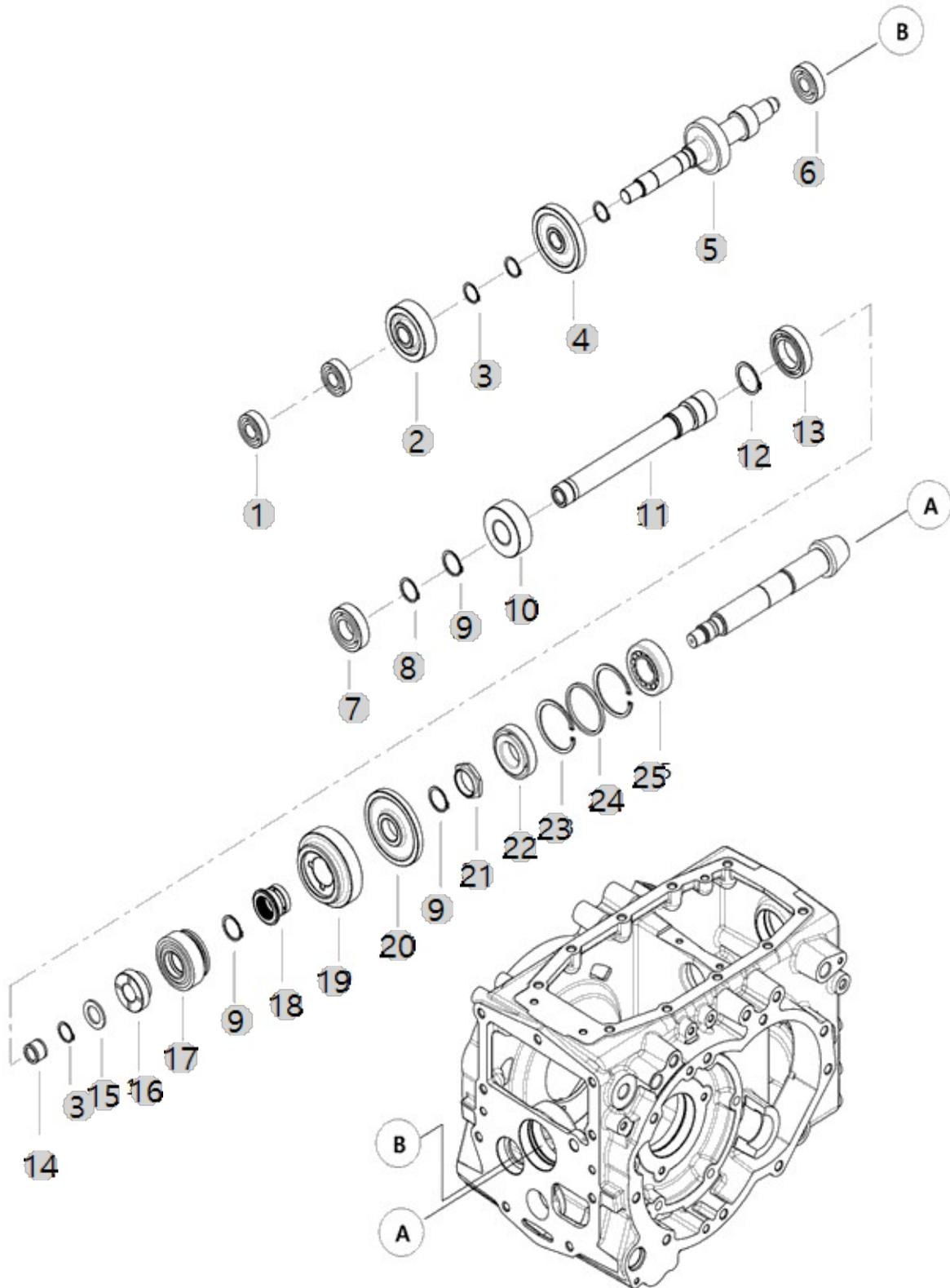





F04010

BRANSON 15H  
TM\_US\_FL(AC01917)

# FRONT DRIVE SHAFT

Year/Month

2022-12-19

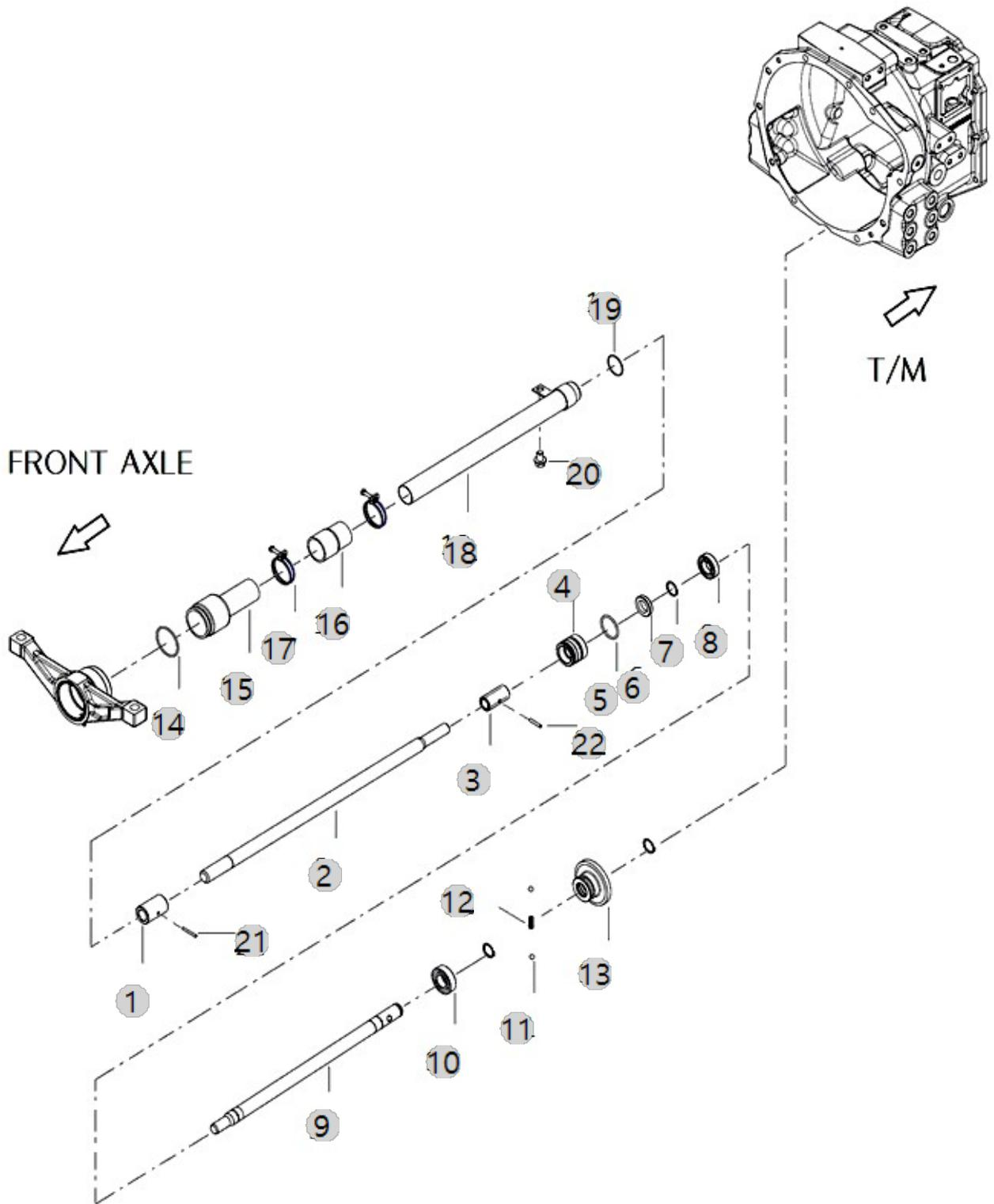



F05020

BRANSON 15H  
TM\_US\_FL(AC01917)

# RING GEAR&DIFF.GEAR ASS'Y

Year/Month

2022-12-19

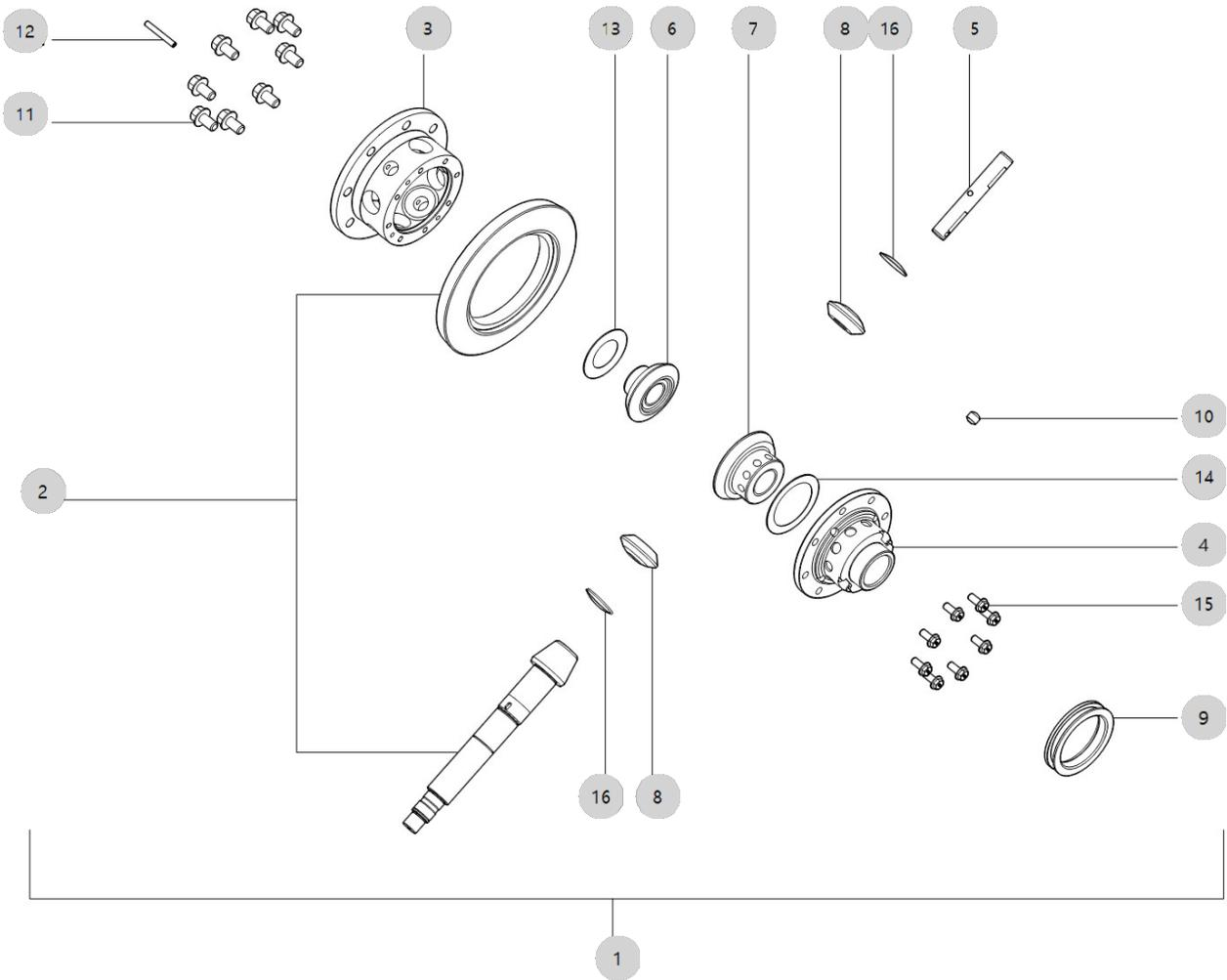



F05020

BRANSON 15H  
TM\_US\_FL(AC01917)

RING GEAR&DIFF.GEAR ASS'Y

Year/Month

2022-12-19

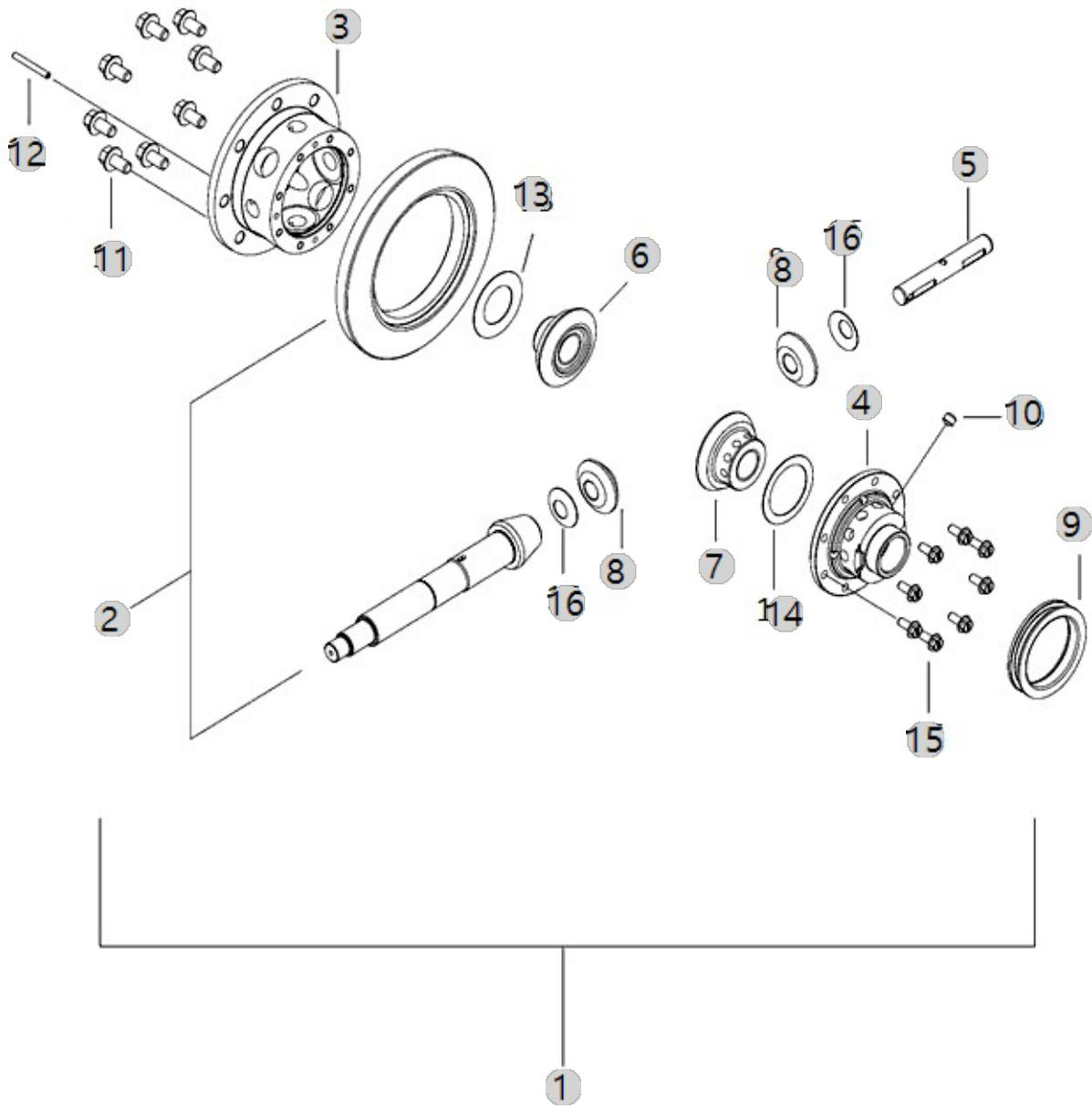



F06030

BRANSON 15H  
TM\_US\_FL(AC01917)

BRAKE

Year/Month

2022-12-19

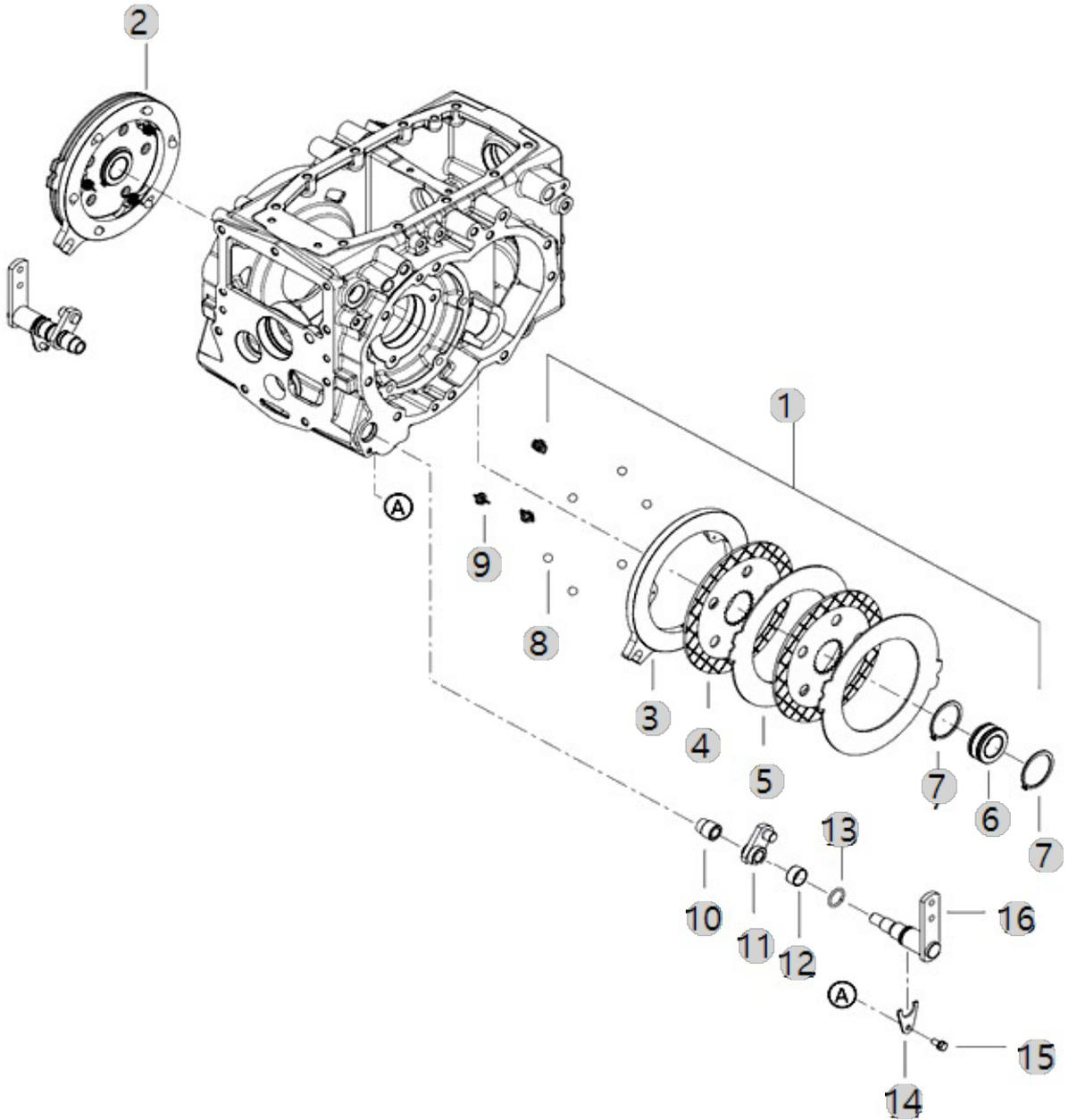





F07030

BRANSON 15H  
TM\_US\_FL(AC01917)

PTO DRIVE SHAFT

Year/Month

2022-12-19

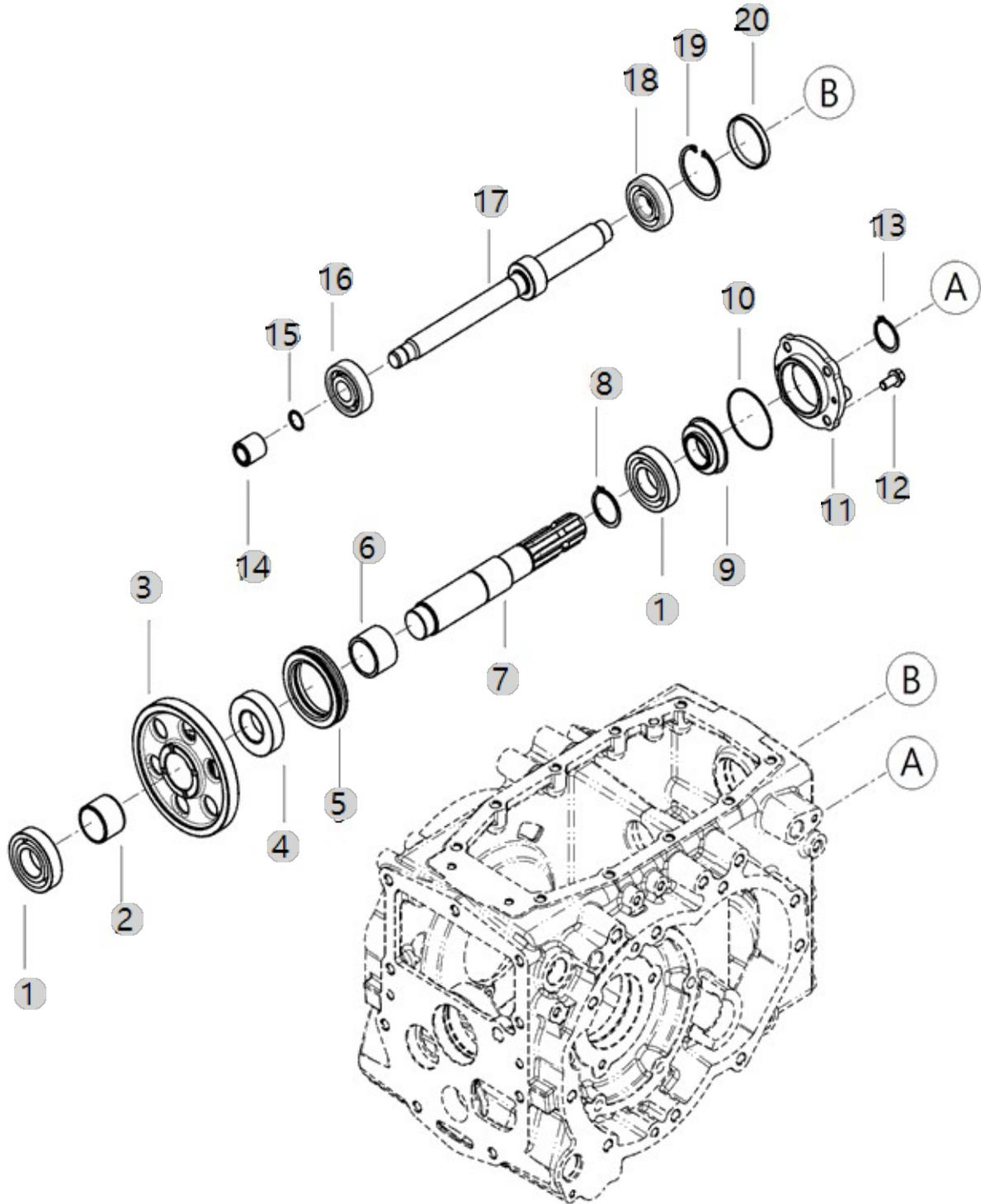



F07070

BRANSON 15H  
TM\_US\_FL(AC01917)

# MAIN P.T.O SHAFT

Year/Month

2022-12-19

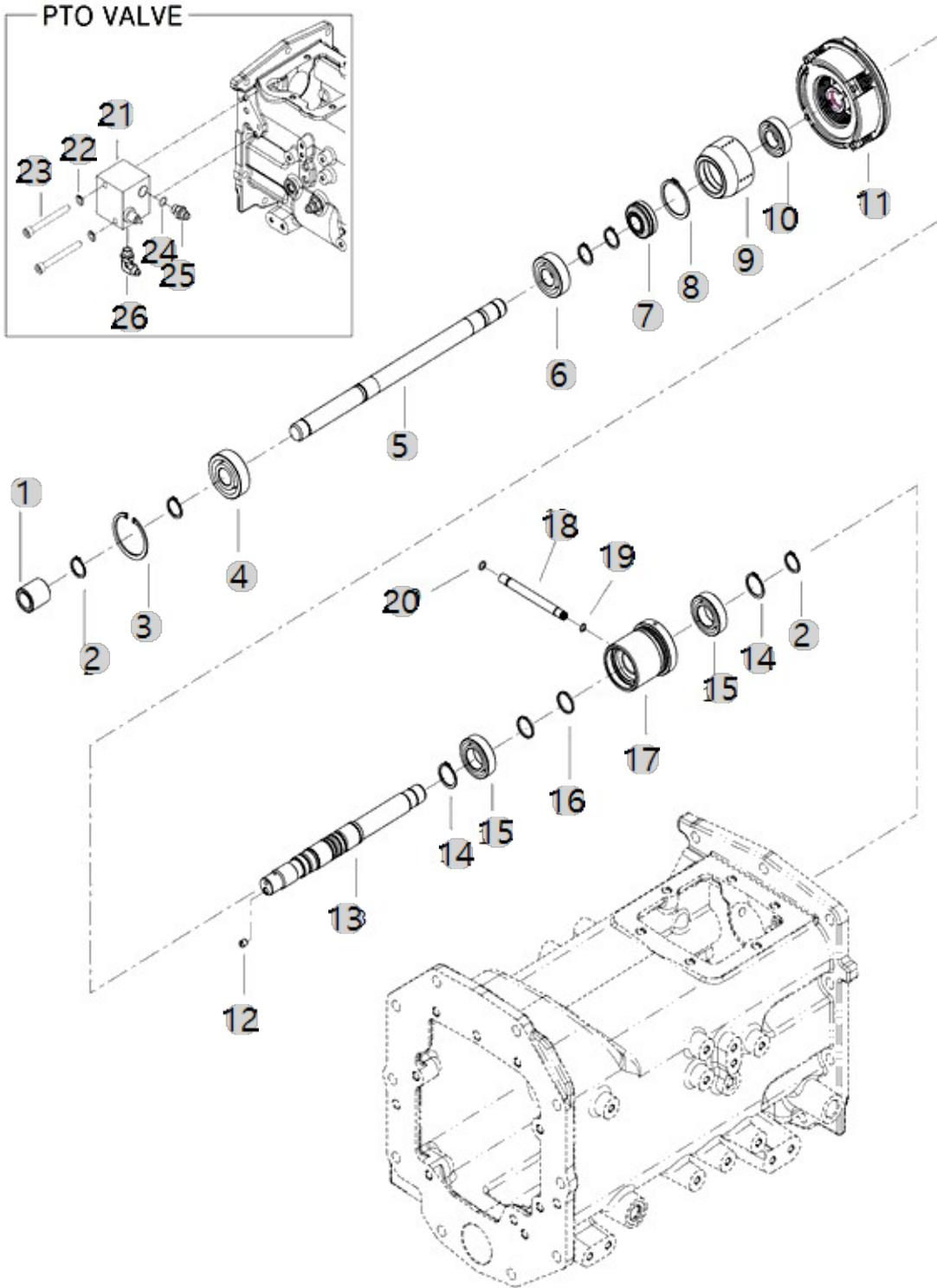



F08060

BRANSON 15H  
TM\_US\_FL(AC01917)

FORK, PTO SHIFT

Year/Month

2022-12-19

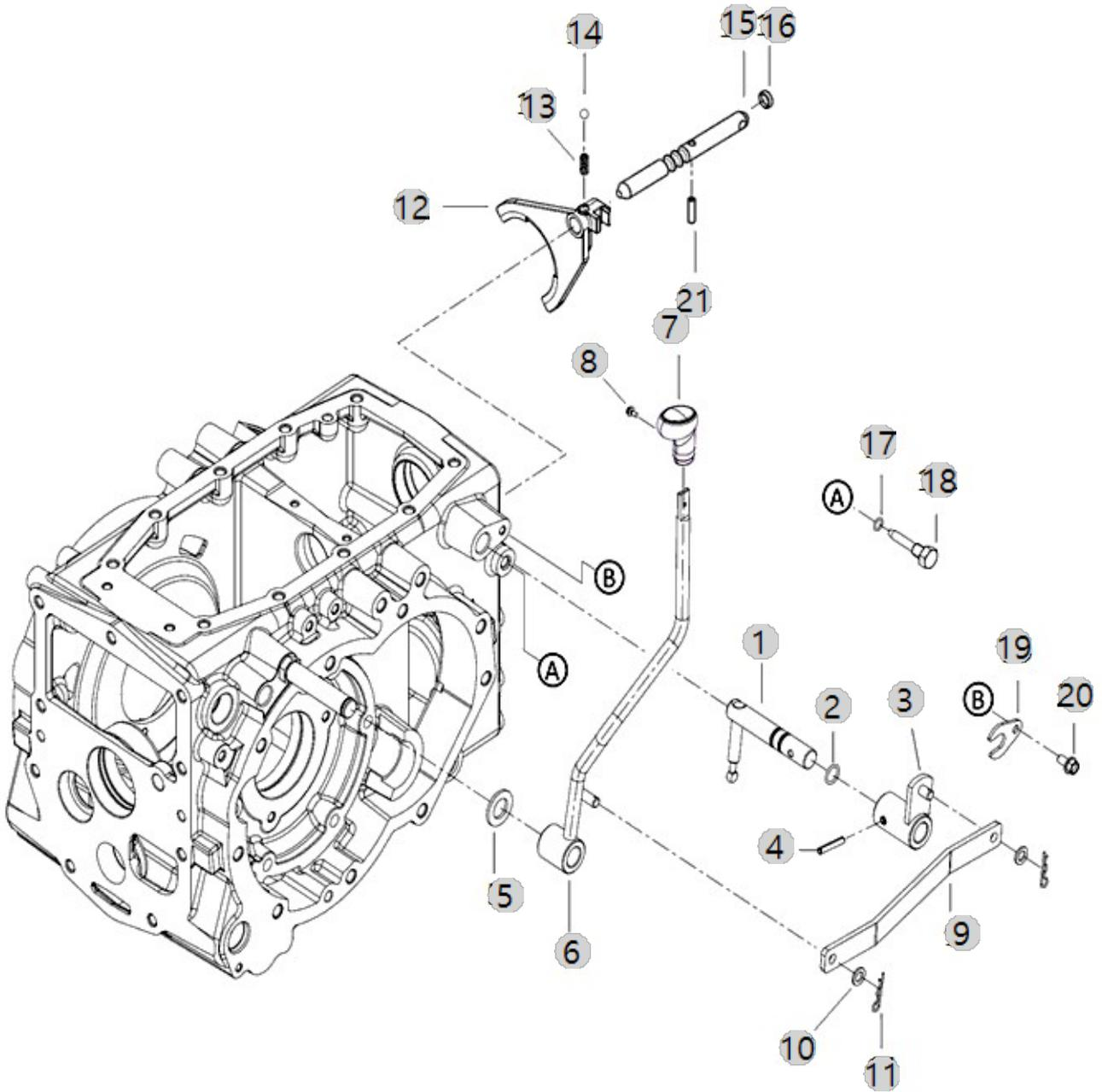



F10010

BRANSON 15H  
TM\_US\_FL(AC01917)

CASE, HYD CYLINDER

Year/Month

2022-12-19

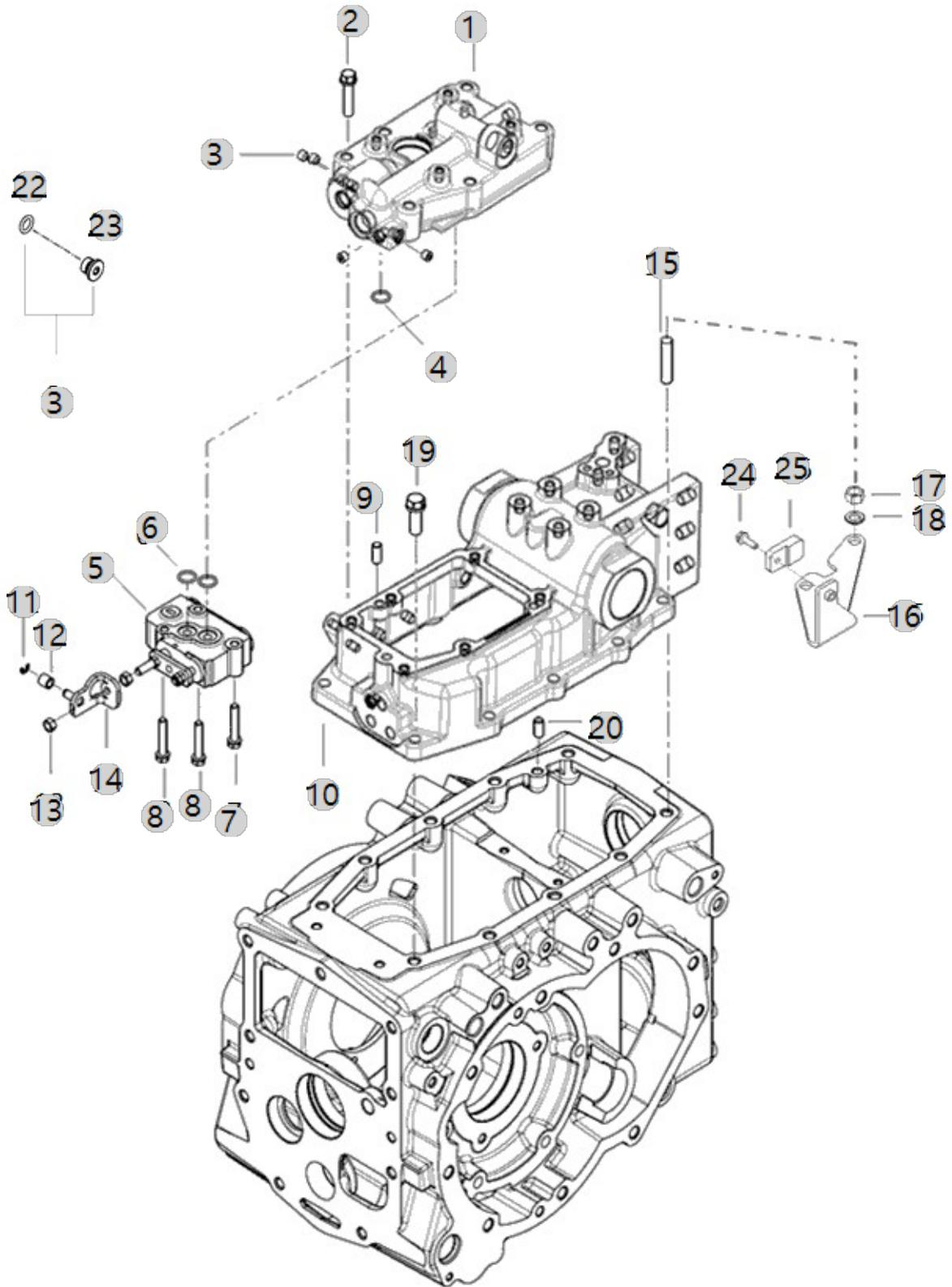





F10020

BRANSON 15H  
TM\_US\_FL(AC01917)

LIFT ARM

Year/Month

2022-12-19

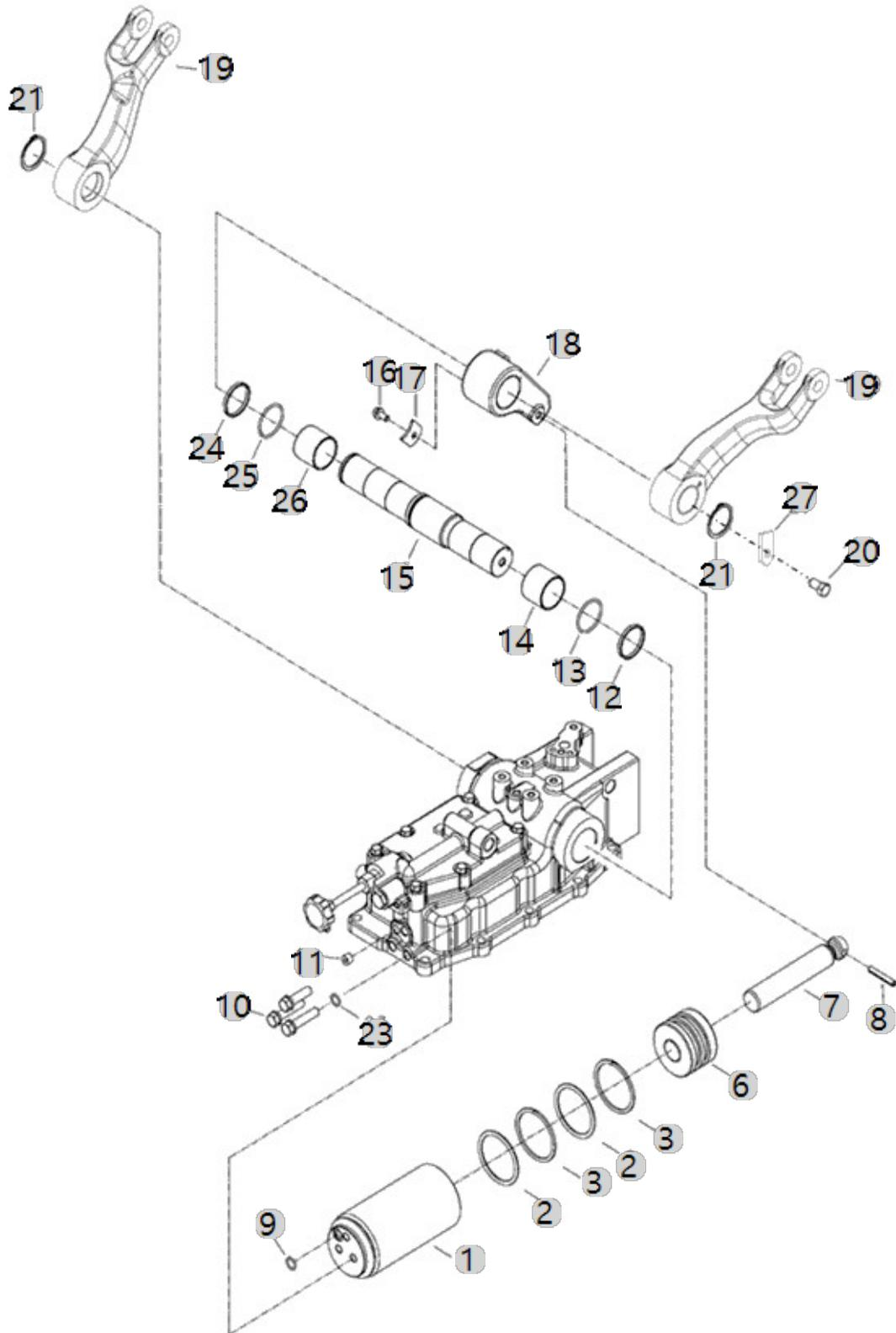



F10030

BRANSON 15H  
TM\_US\_FL(AC01917)

### SAFETY VALVE

Year/Month

2022-12-19

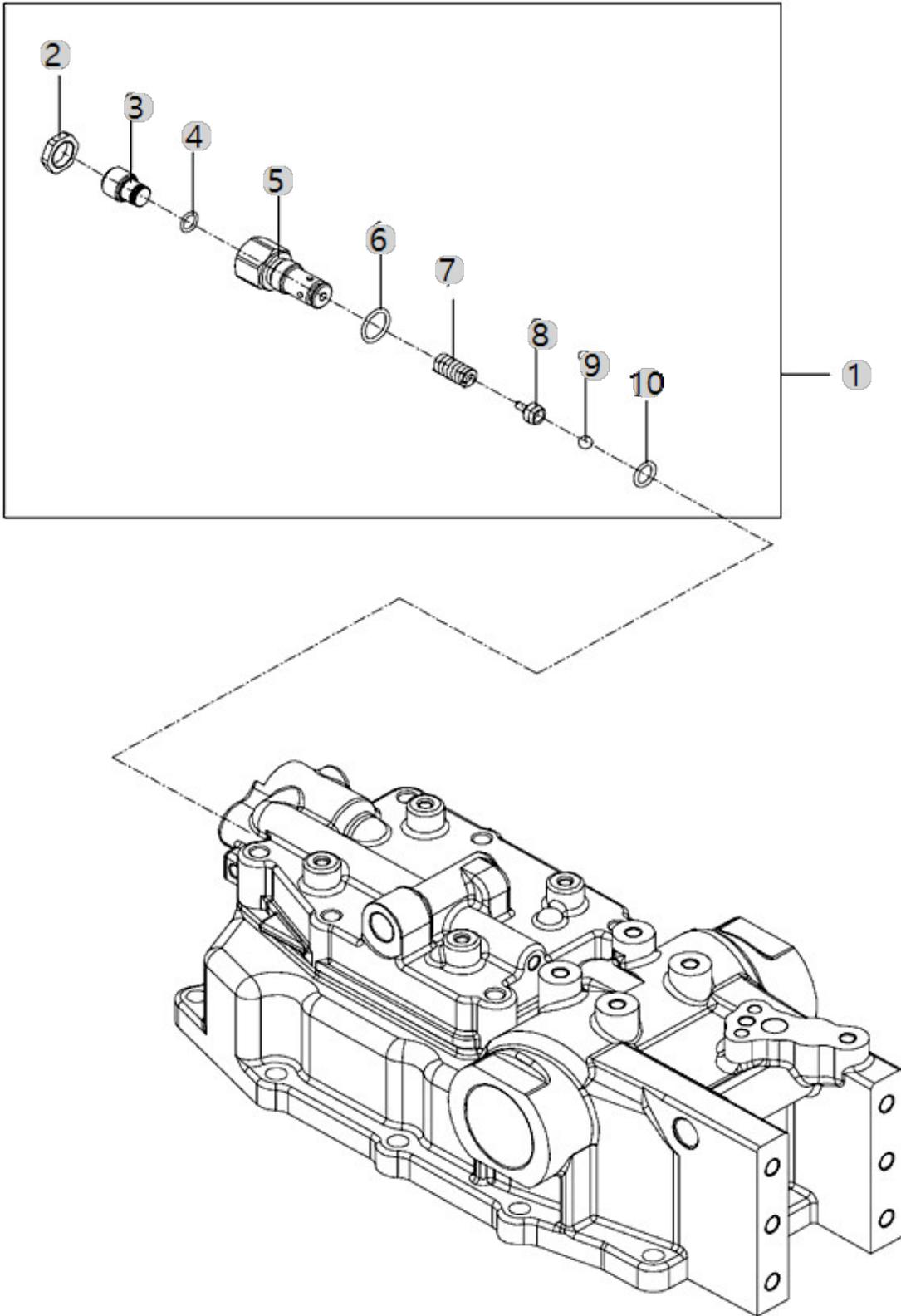



F10031

BRANSON 15H  
TM\_US\_FL(AC01917)

RELIEF VALVE

Year/Month

2022-12-19

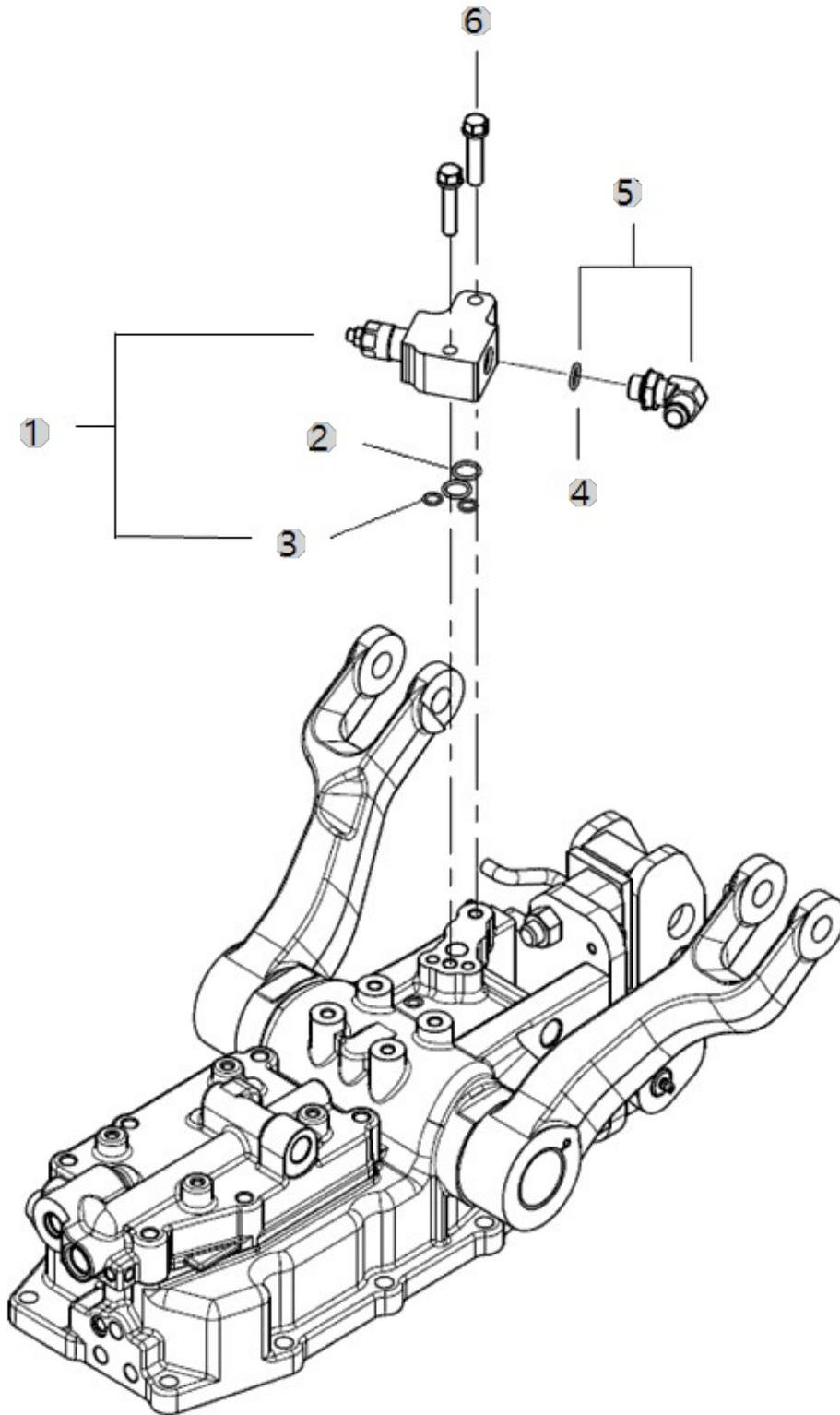



F10040

BRANSON 15H  
TM\_US\_FL(AC01917)

### STOP VALVE

Year/Month

2022-12-19

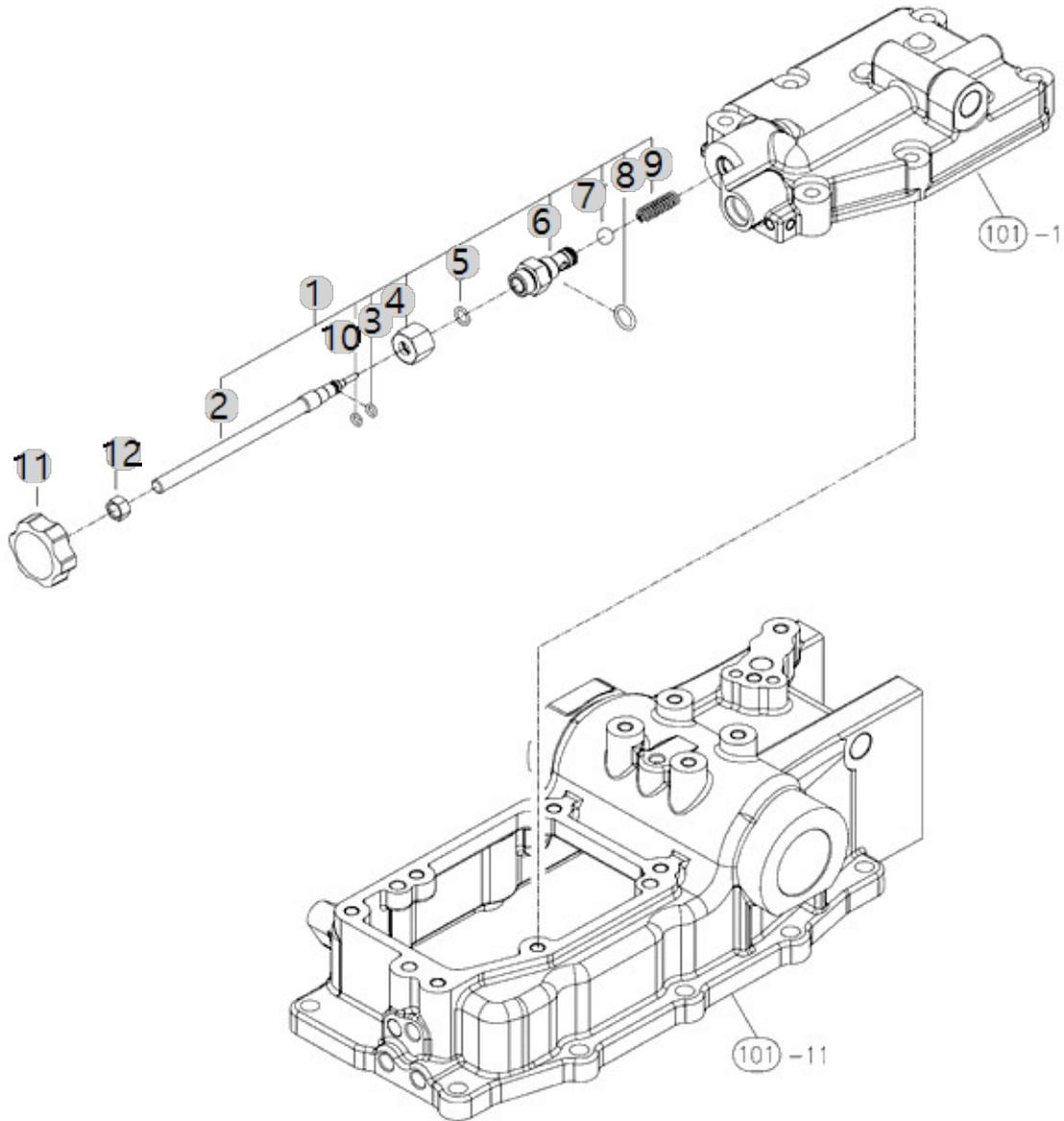





F10061

BRANSON 15H  
TM\_US\_FL(AC01917)

DRAFT/POSITION CONTROL LEVER

Year/Month

2022-12-19

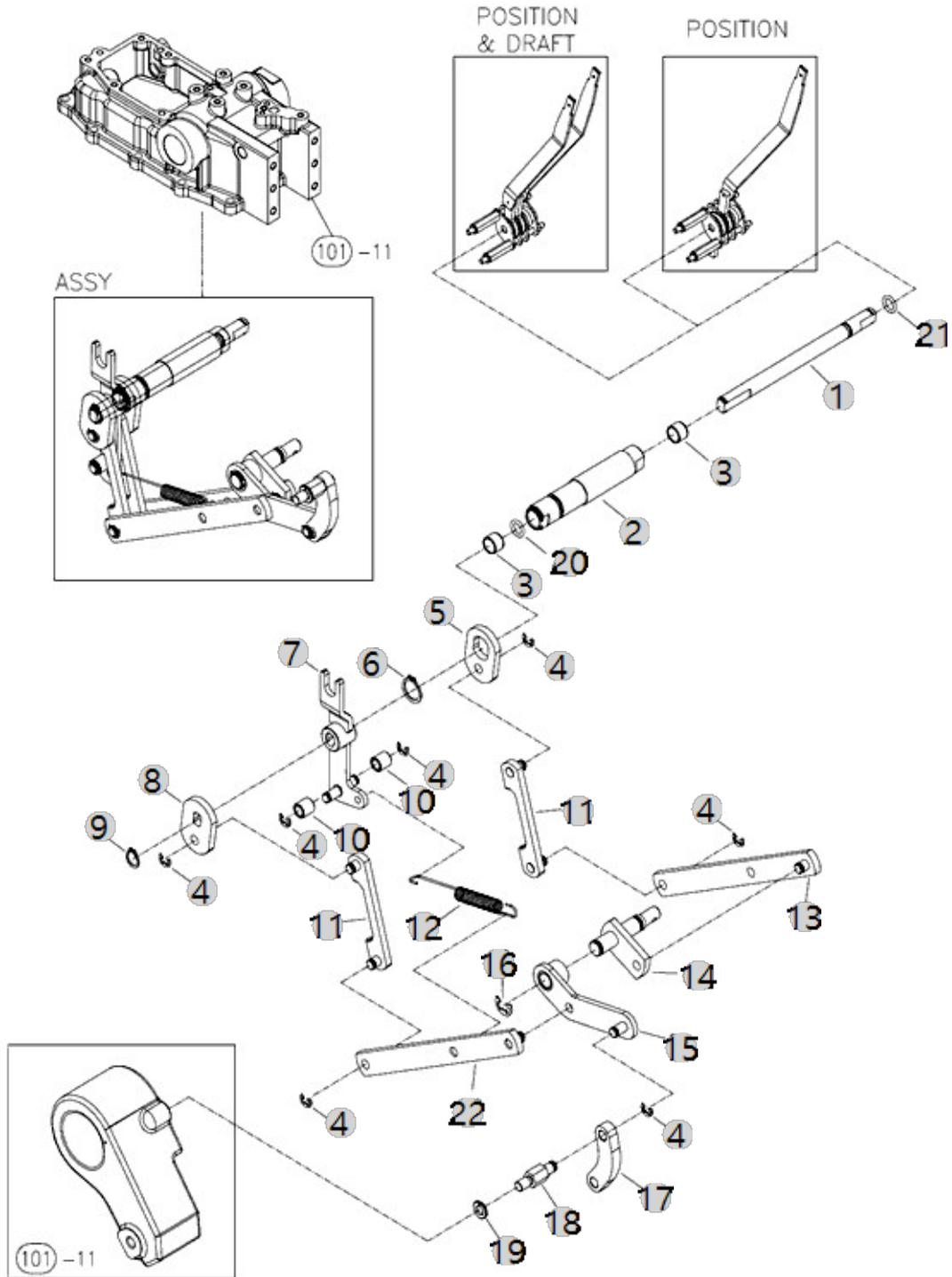



F10063

BRANSON 15H  
TM\_US\_FL(AC01917)

DRAFT CONTROL LEVER

Year/Month

2022-12-19

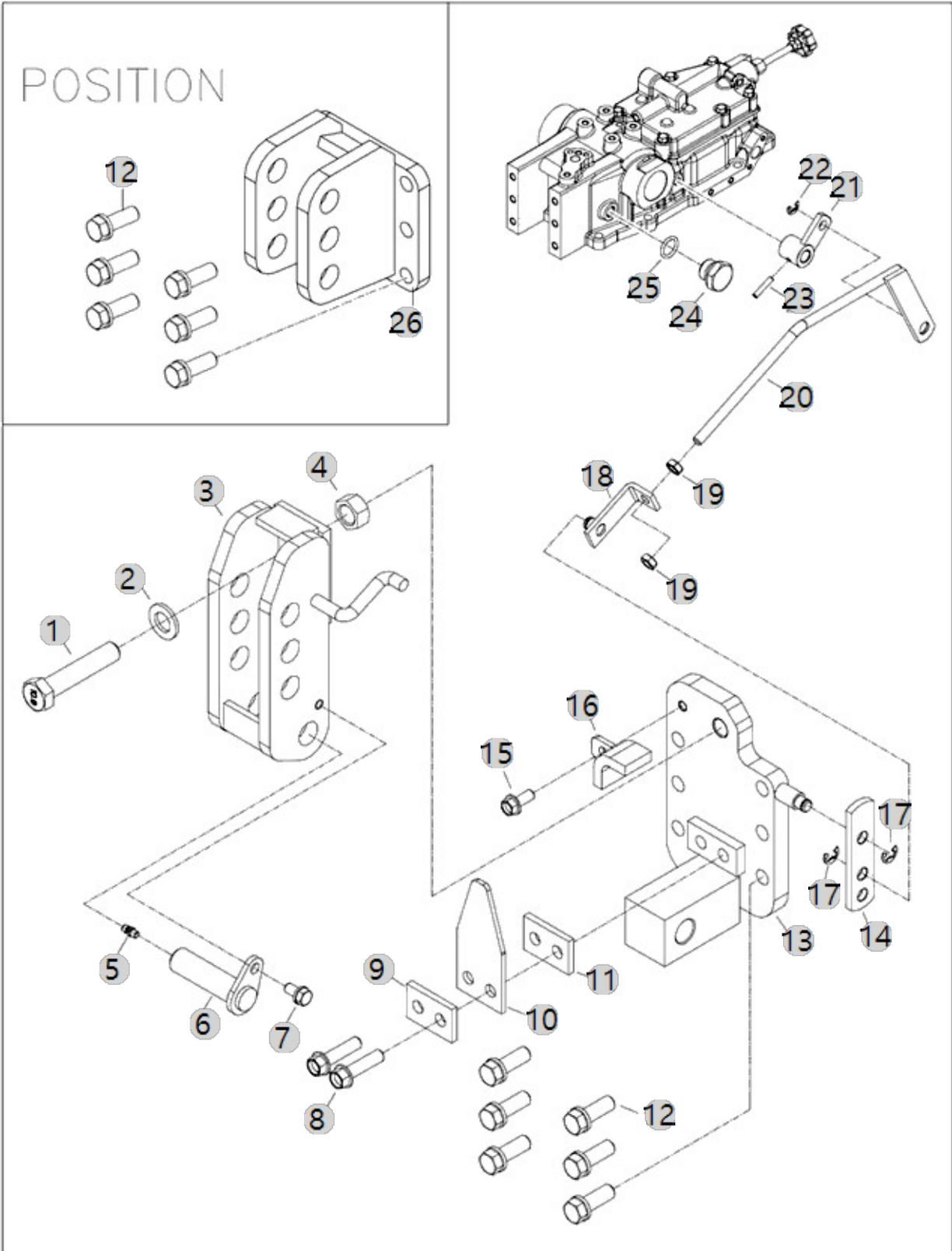



F10064

BRANSON 15H  
TM\_US\_FL(AC01917)

POSITION CONTROL LEVER

Year/Month

2022-12-19

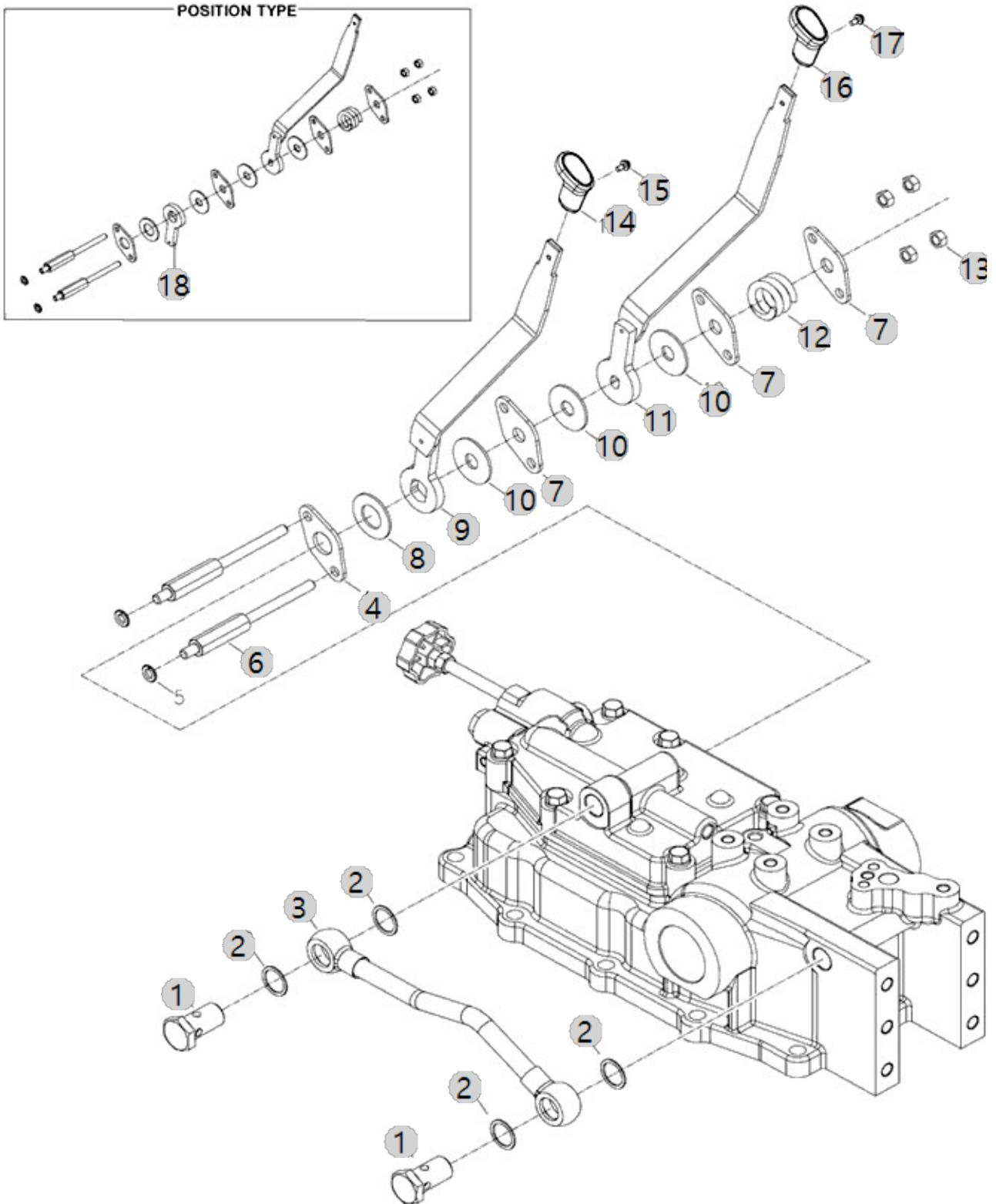



F11020

BRANSON 15H  
TM\_US\_FL(AC01917)

LEVER ASS'Y, RANGE SHIFT

Year/Month

2022-12-19

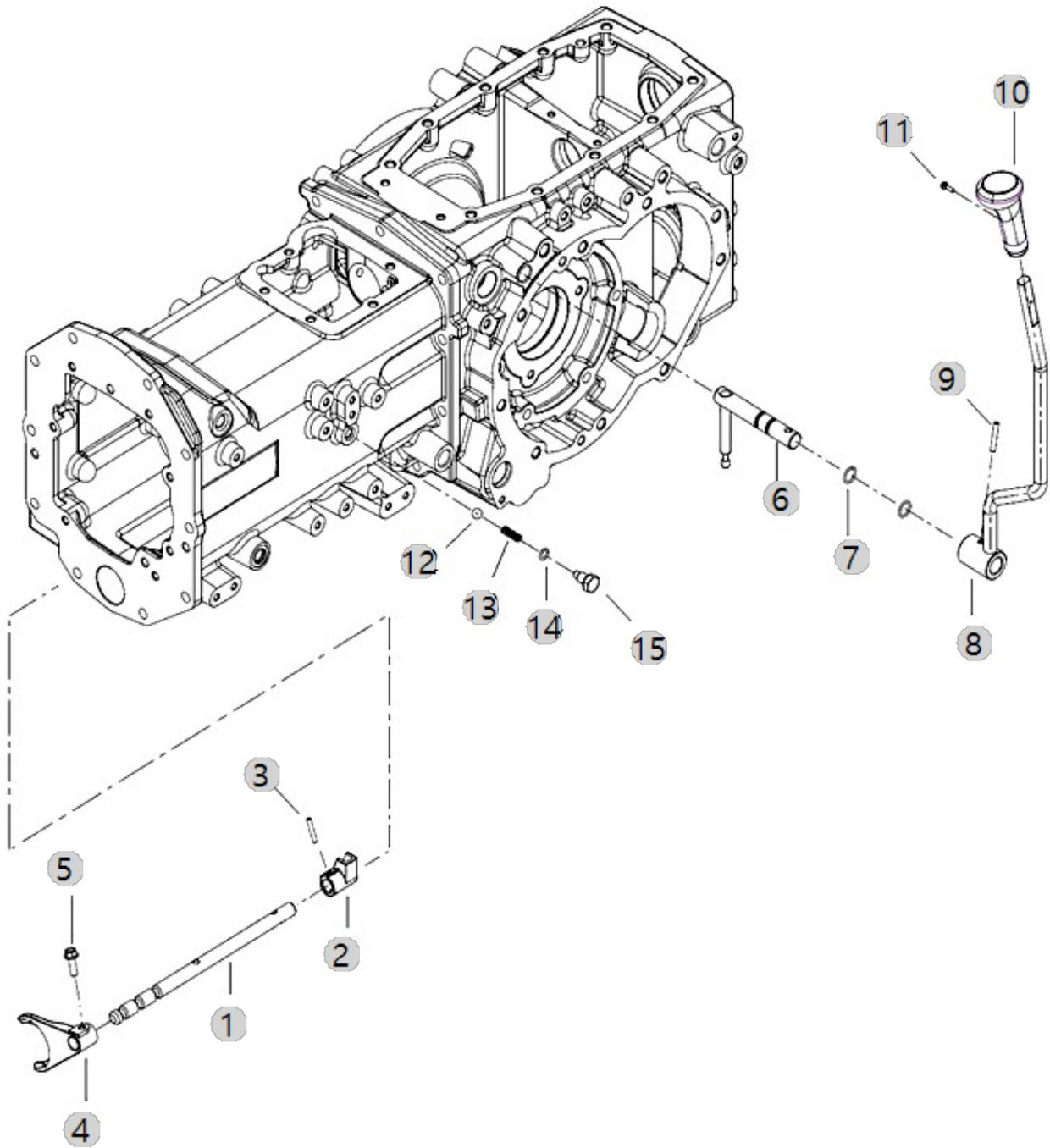





F11060

BRANSON 15H  
TM\_US\_FL(AC01917)

DIFF. LOCK PEDAL

Year/Month

2022-12-19

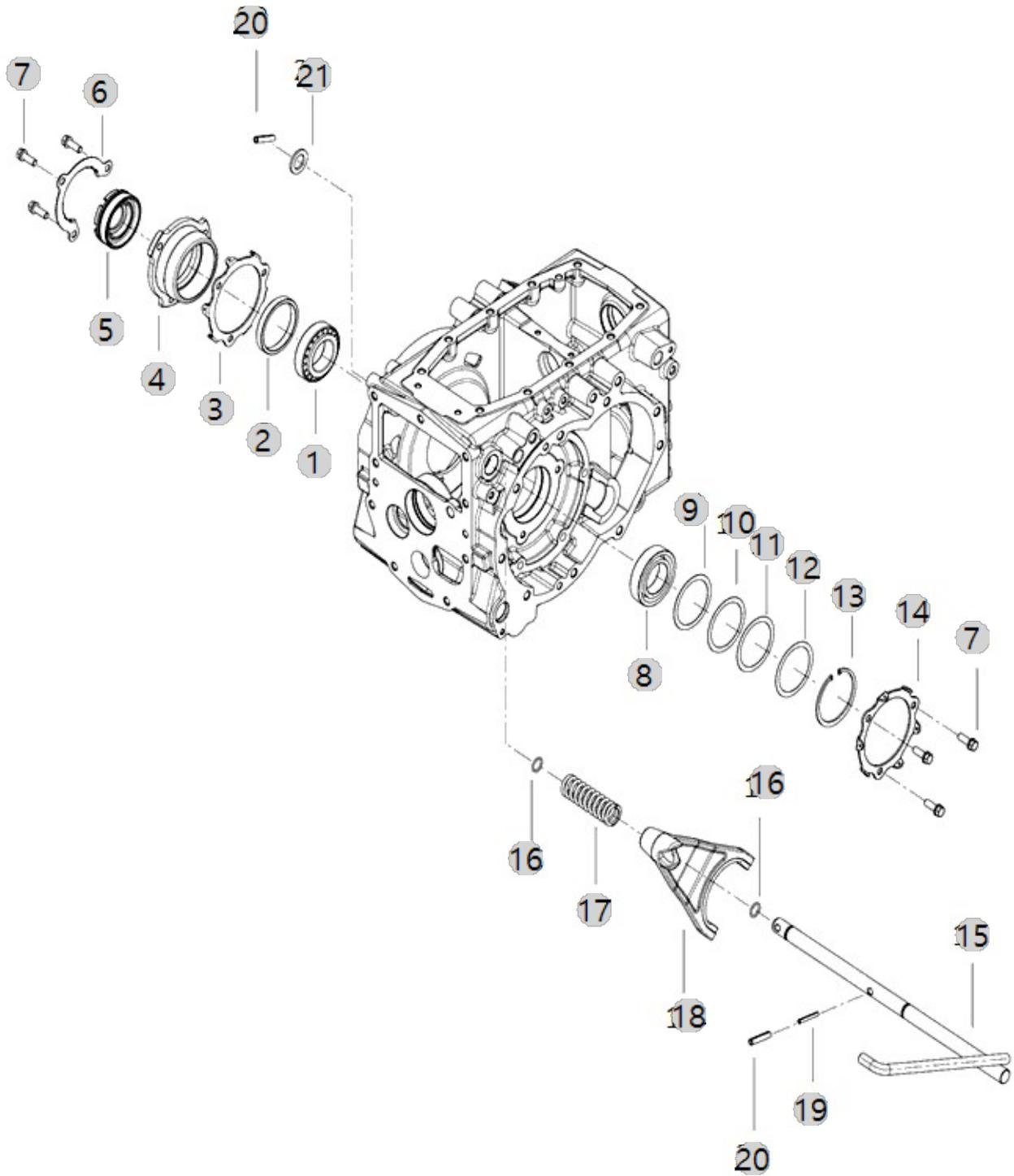



F11080

BRANSON 15H  
TM\_US\_FL(AC01917)

4WD LEVER

Year/Month

2022-12-19

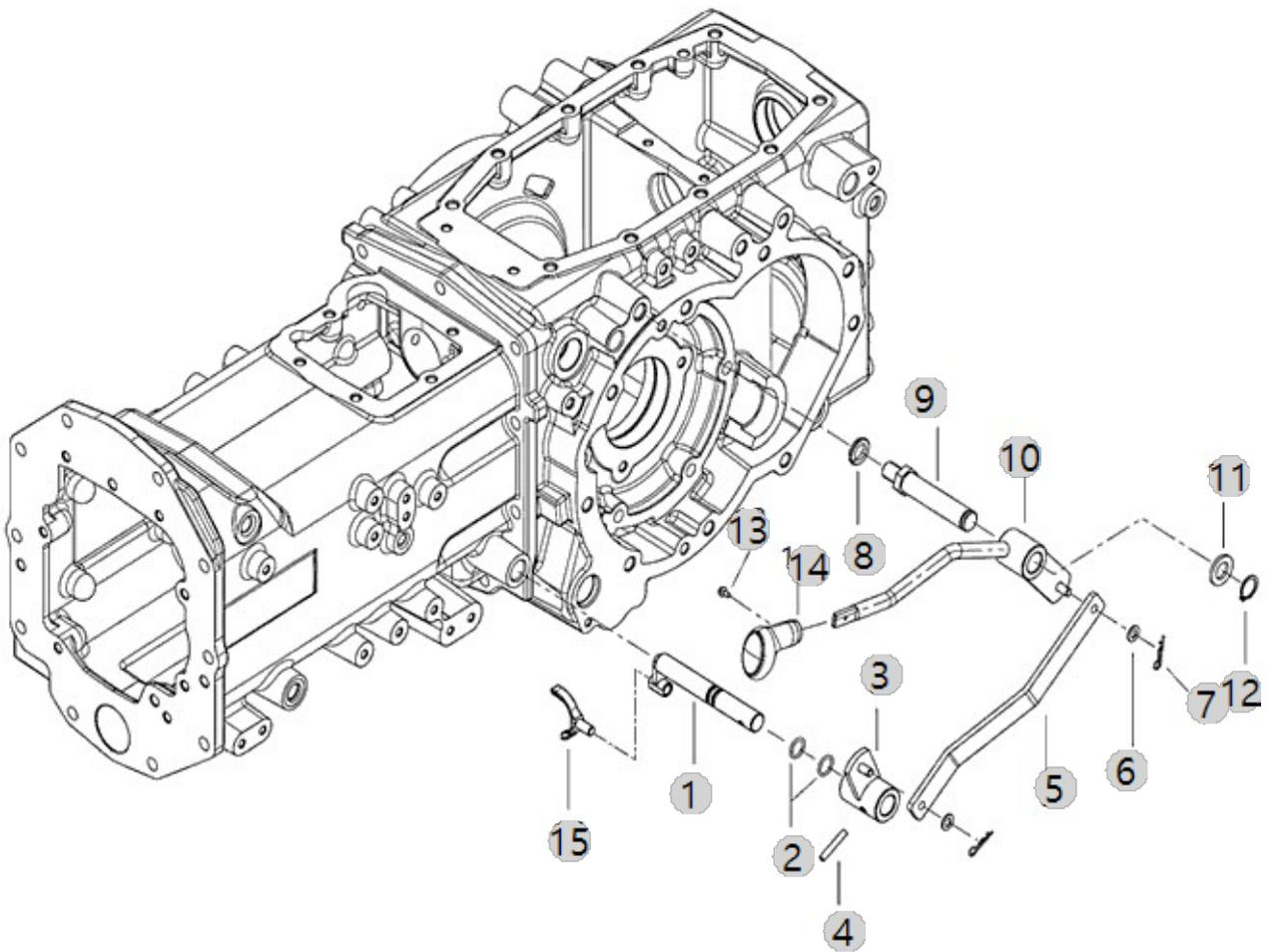



G01020

4815H\_US\_FL  
(AC02166)

BONNET

Year/Month

2022-12-19

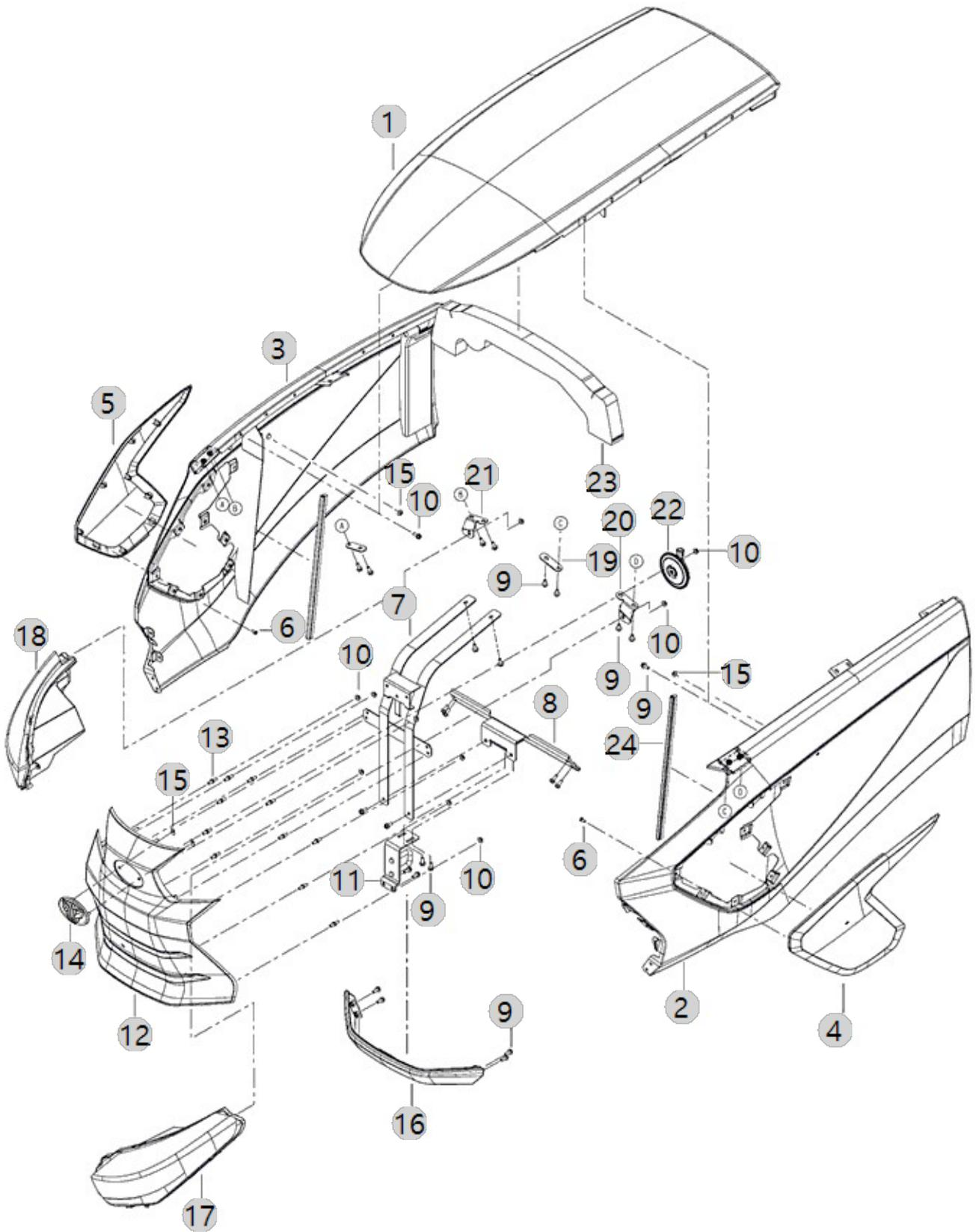



G01040

4815H\_US\_FL  
(AC02166)

LOCKING ASS'Y, BONNET

Year/Month

2022-12-19

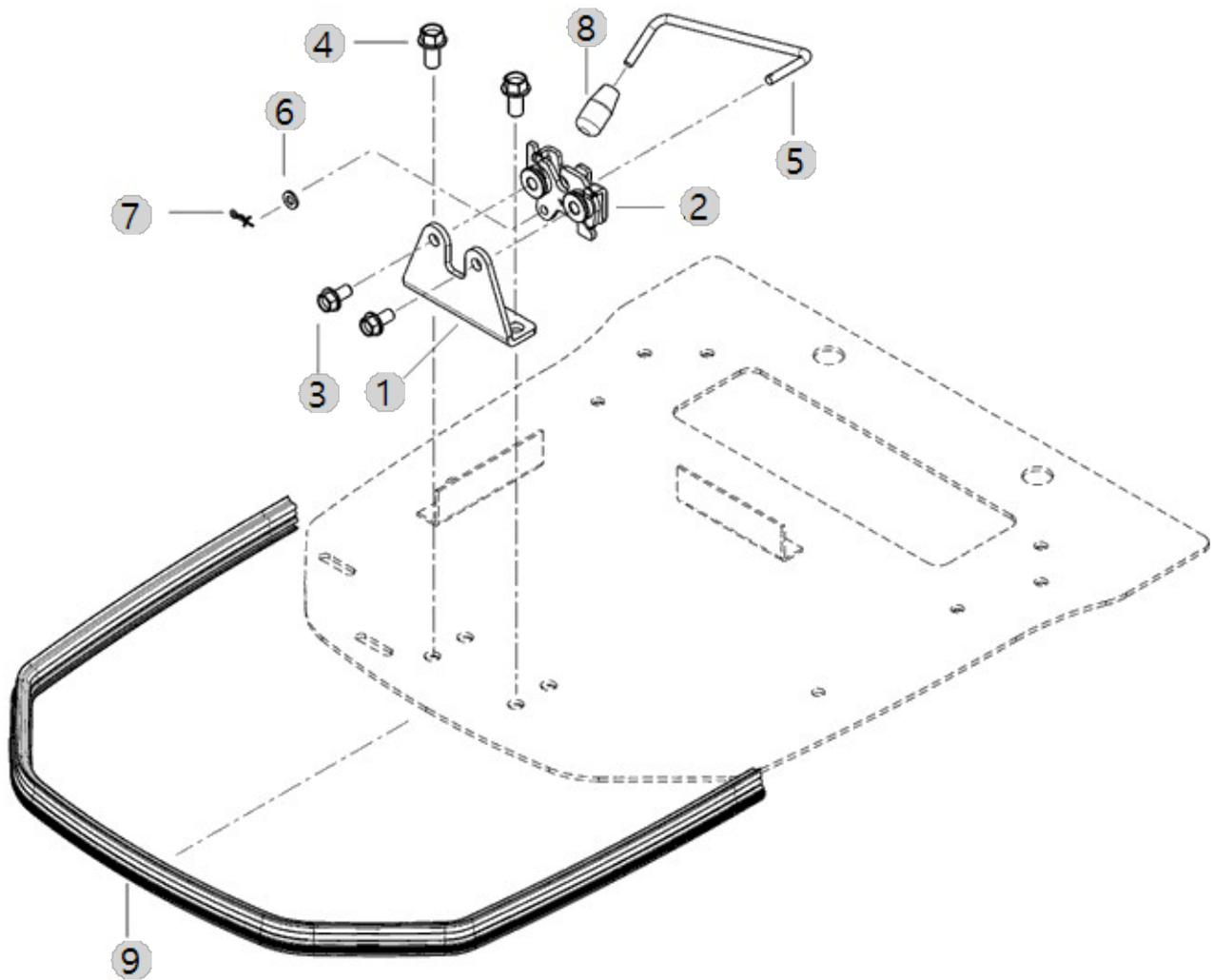





G01060-B

4815H\_US\_FL  
(AC02166)

BONNET SUPPORT

Year/Month

2022-12-19

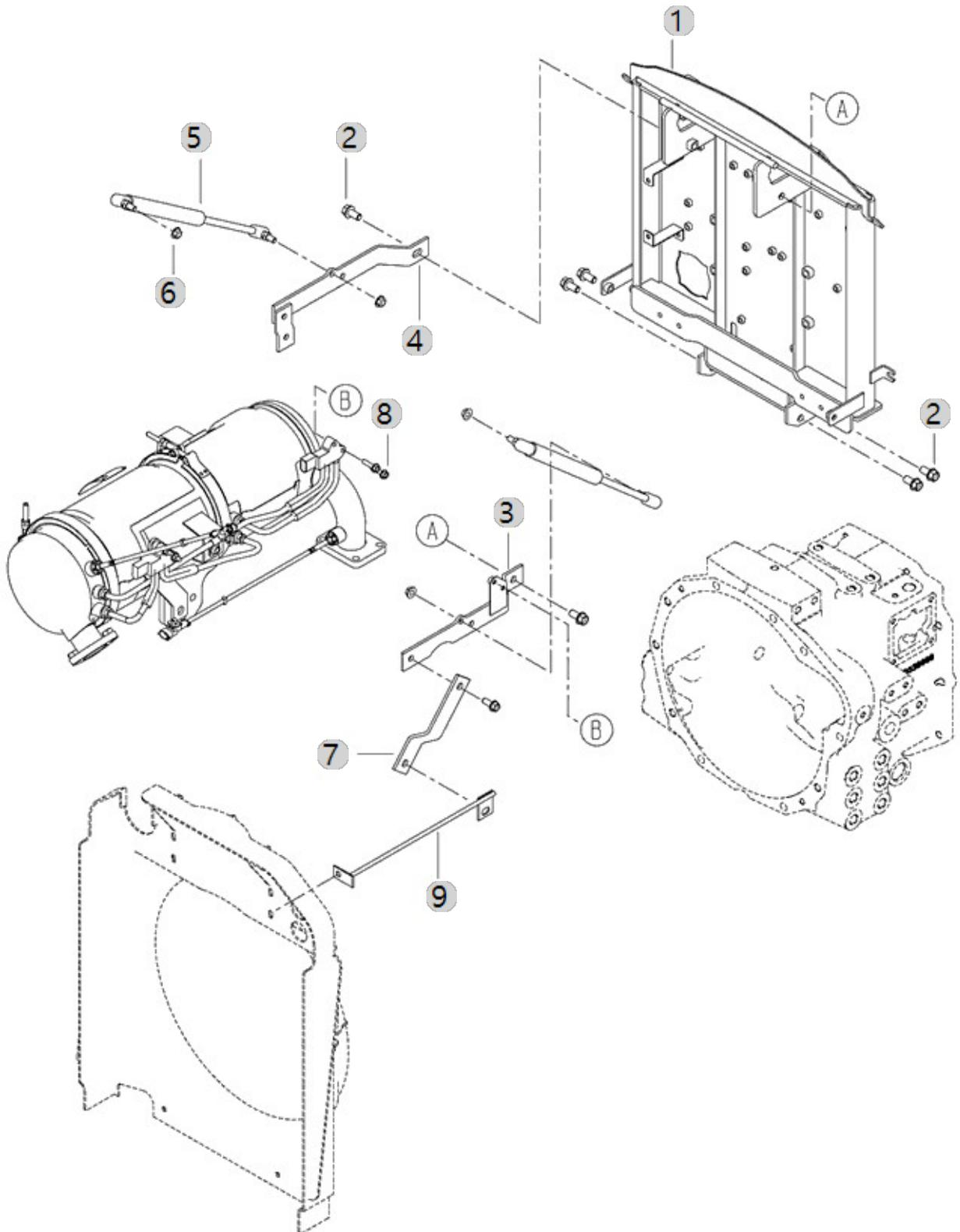



G01062

4815H\_US\_FL  
(AC02166)

FIXED BRACKET, BONNET

Year/Month

2022-12-19

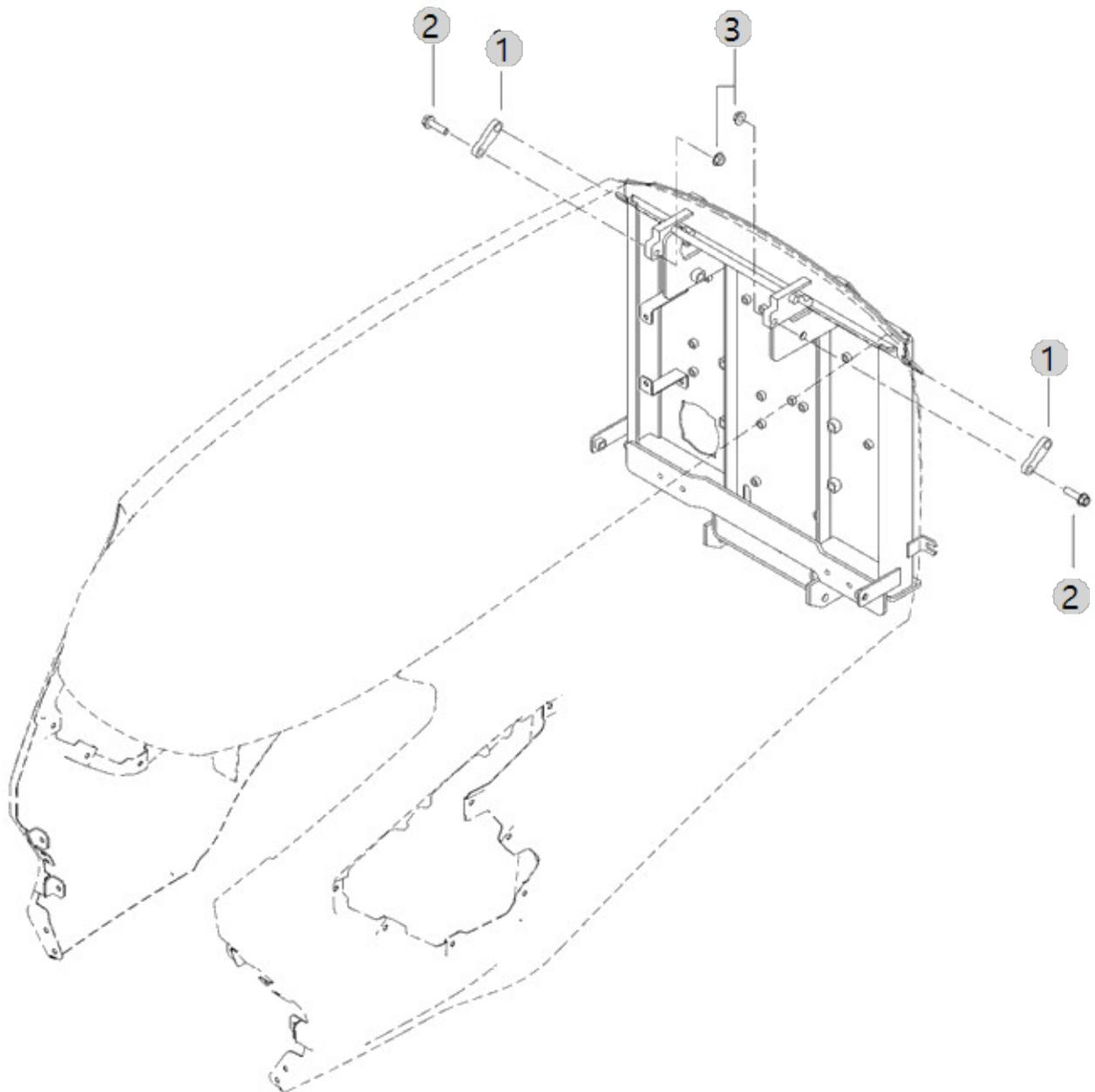



G01080

4815H\_US\_FL  
(AC02166)

FRONT AXLE BRACKET

Year/Month

2022-12-19

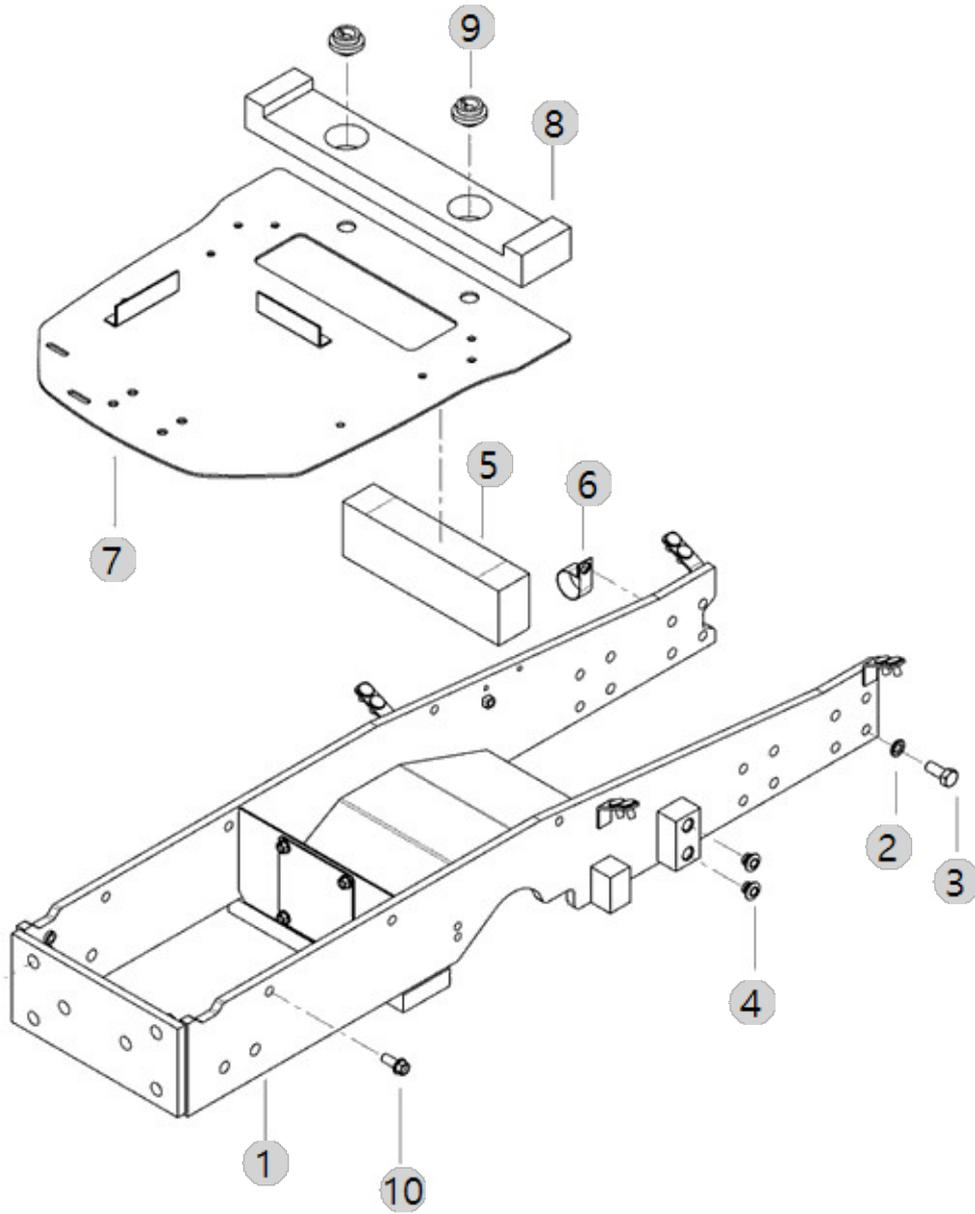



G04060

4815H\_US\_FL  
(AC02166)

# FOOT REST ASS'Y

Year/Month

2022-12-19

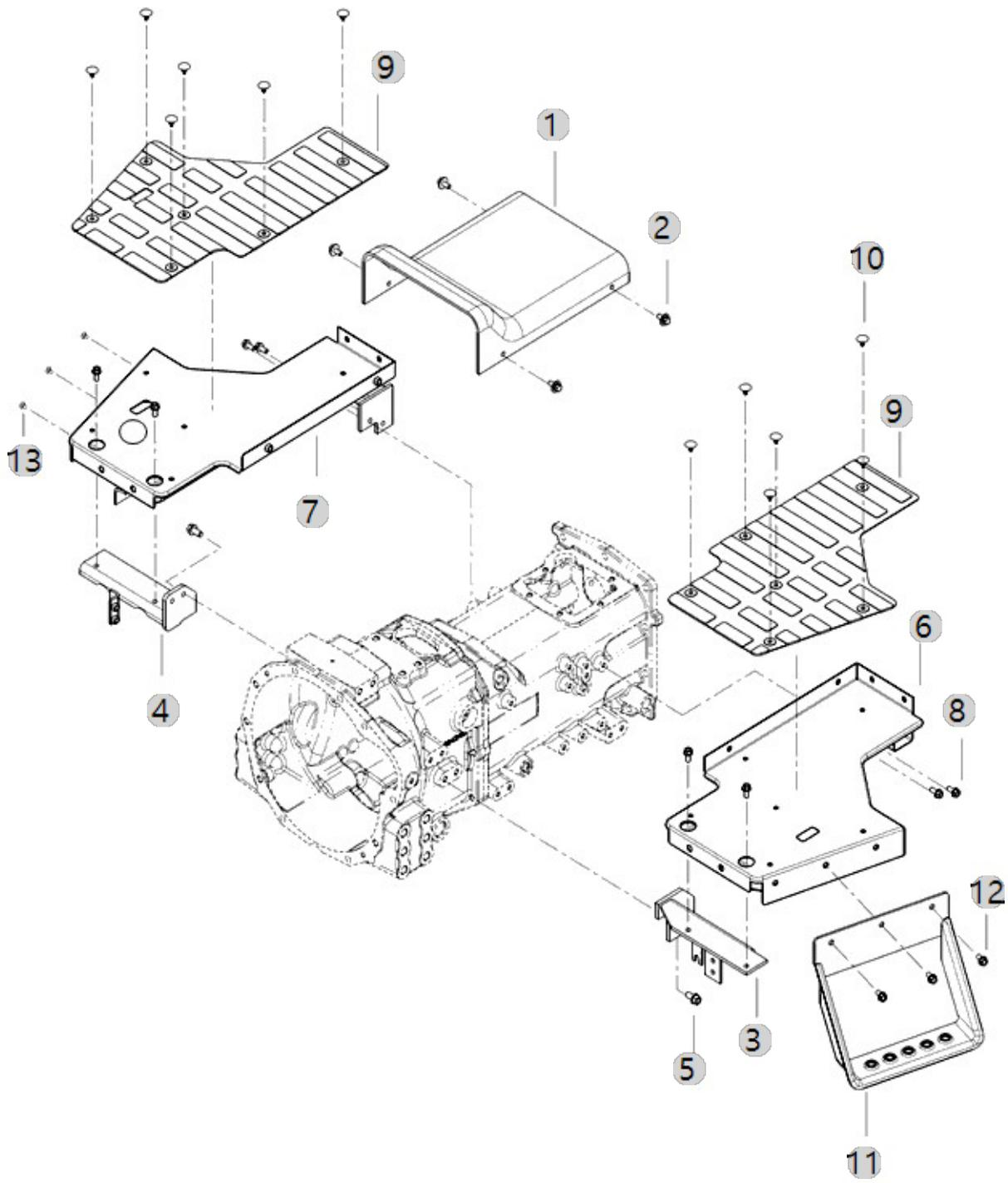





G04070

4815H\_US\_FL  
(AC02166)

SEAT

Year/Month

2022-12-19

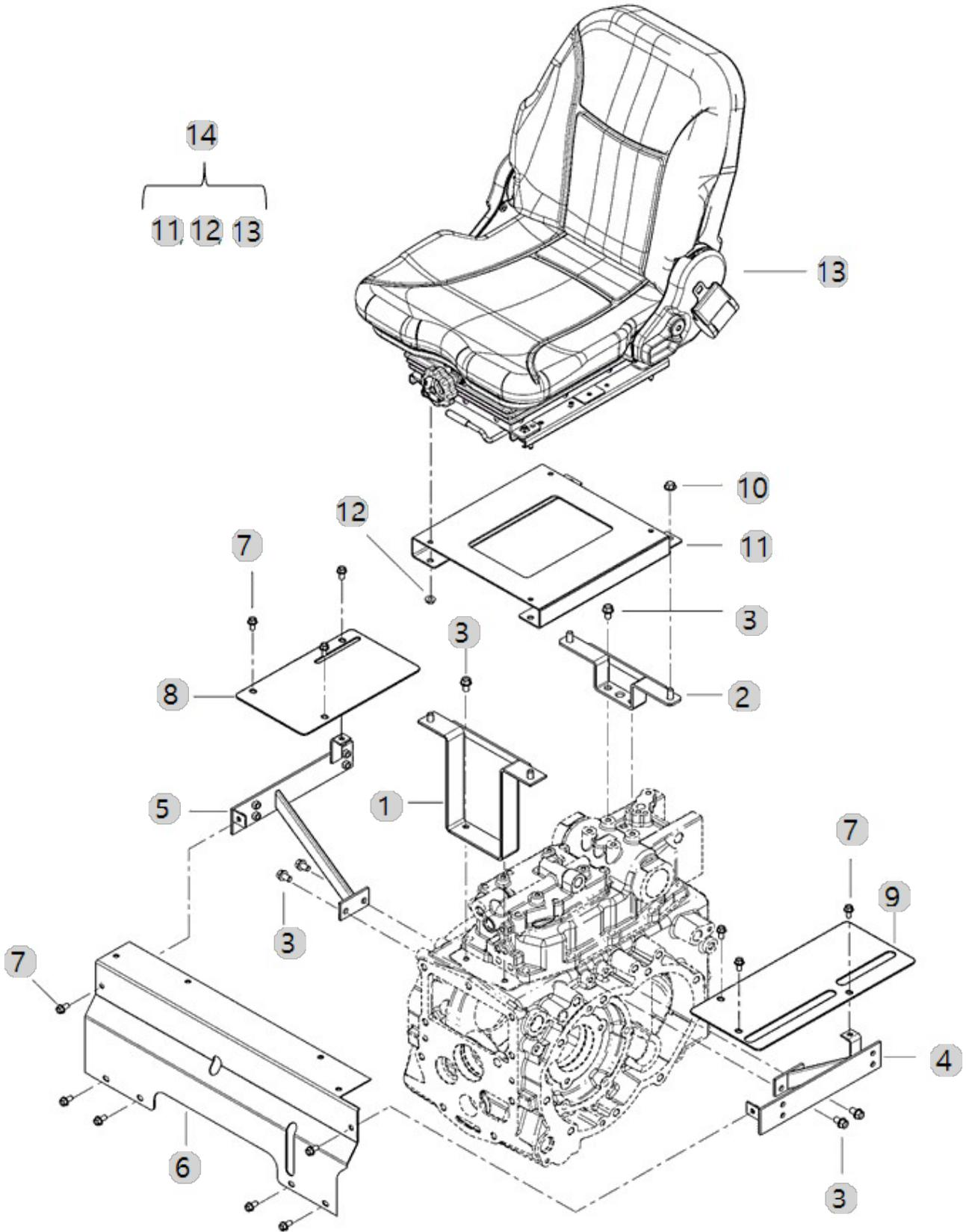



G04090

4815H\_US\_FL  
(AC02166)

FENDER

Year/Month

2022-12-19

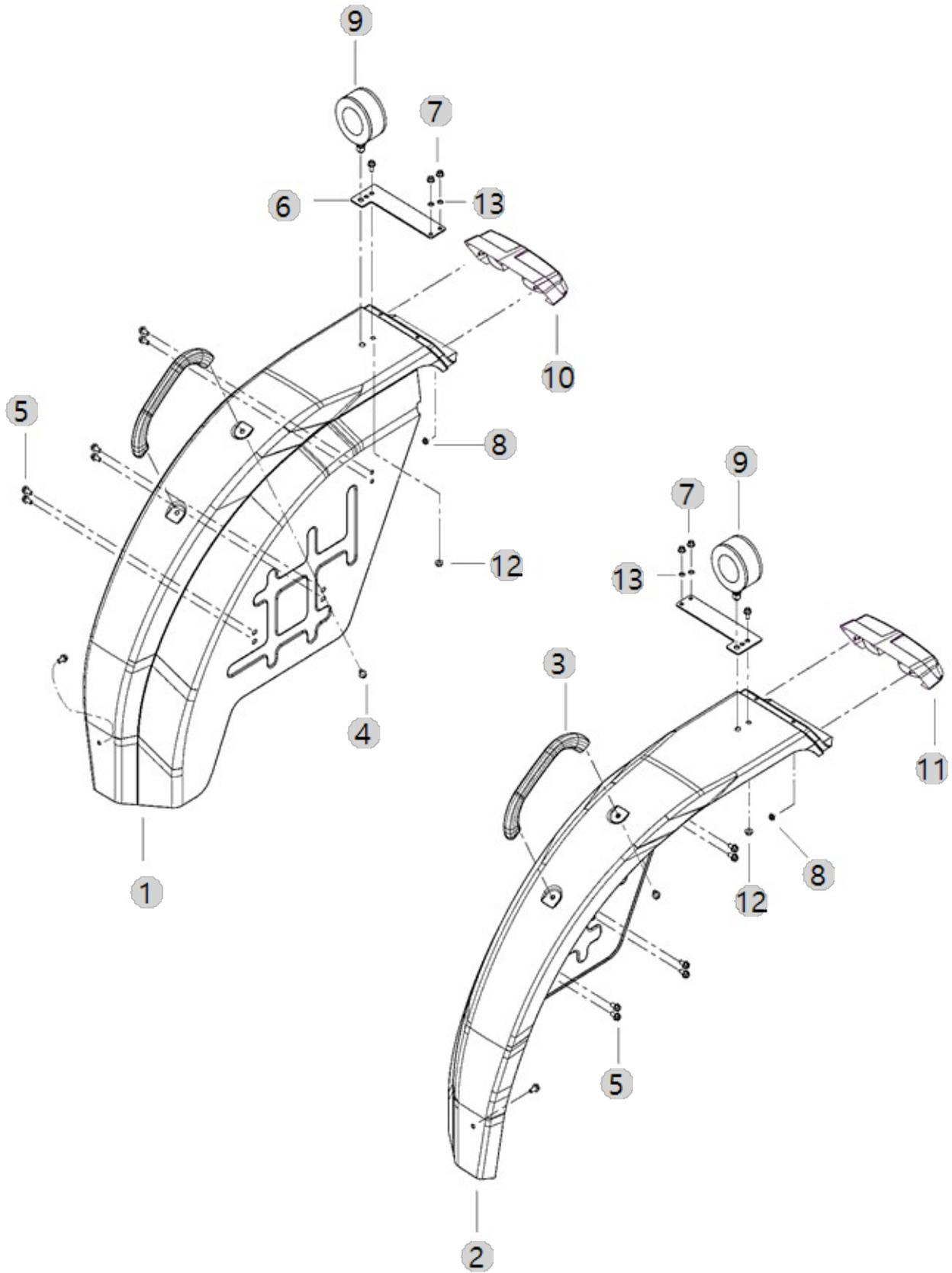



G04120

4815H\_US\_FL  
(AC02166)

### ROPS FRAME ASS'Y

Year/Month

2022-12-19

#### WORKING LAMP(OPTION)

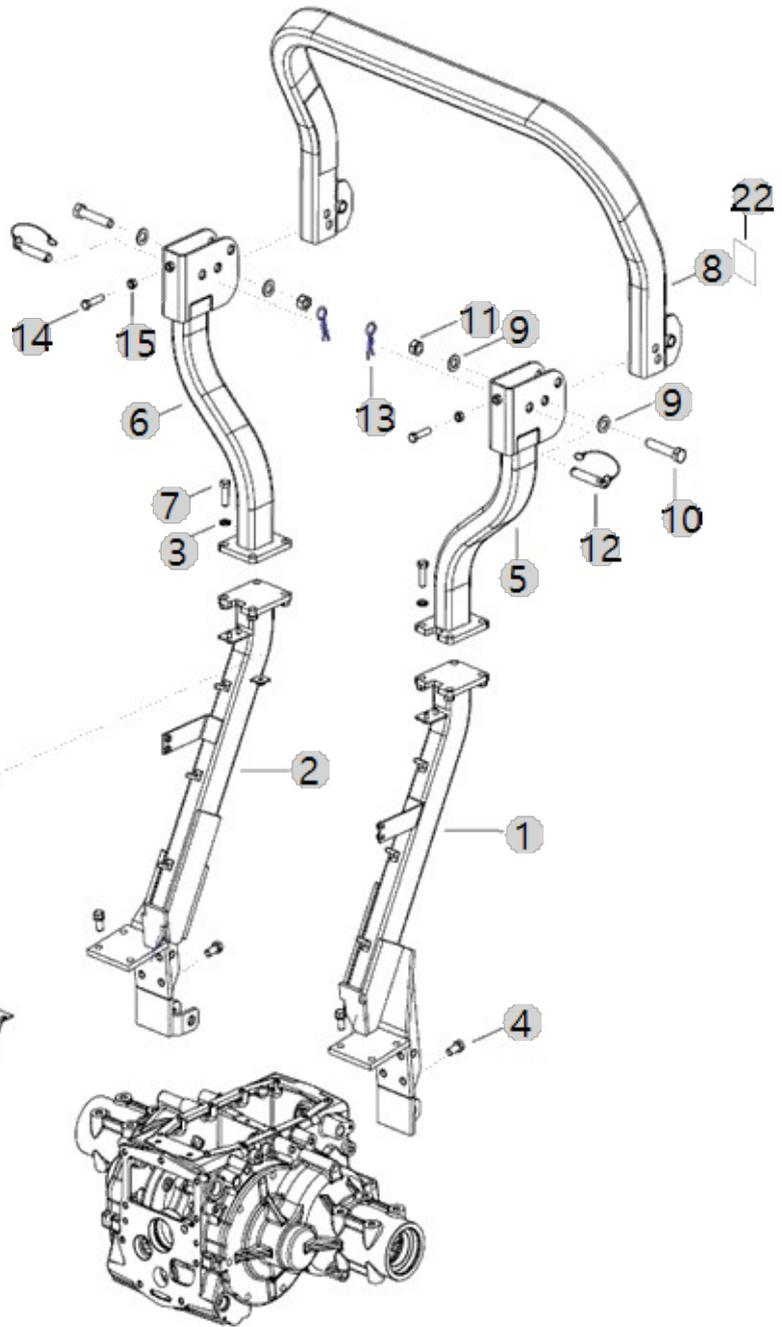
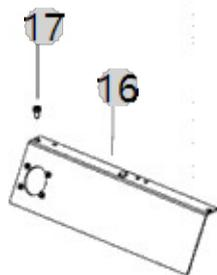
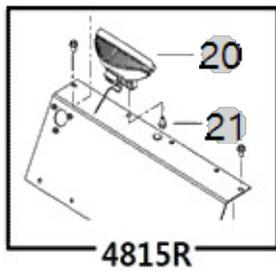
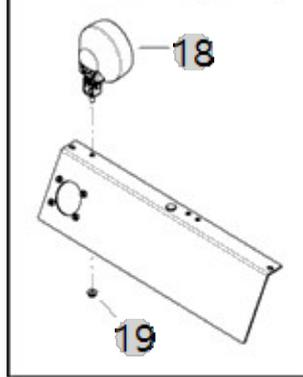



G05020

4815H\_US\_FL  
(AC02166)

TOP LINK

Year/Month

2022-12-19

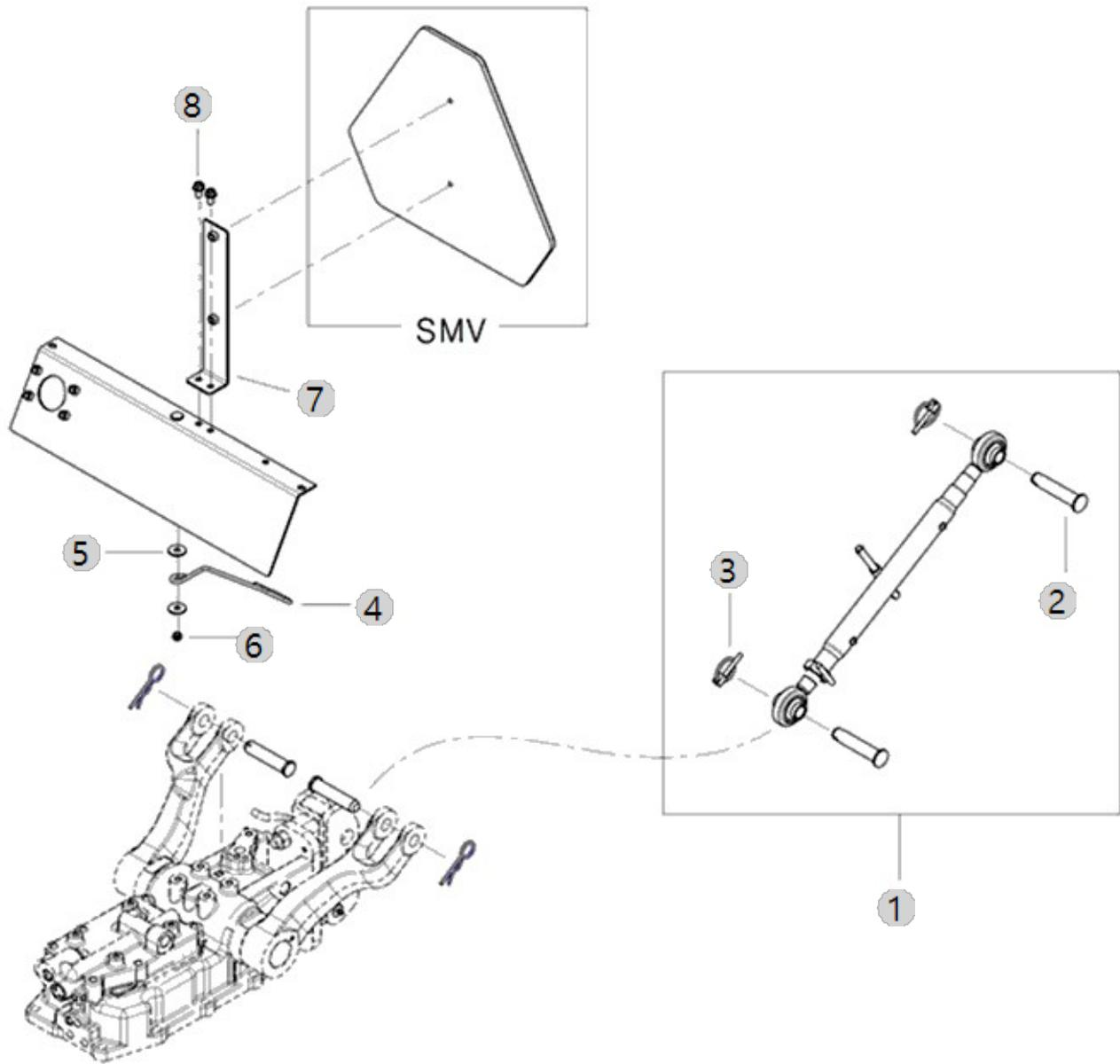





G05030

4815H\_US\_FL  
(AC02166)

LOWER LINK

Year/Month

2022-12-19

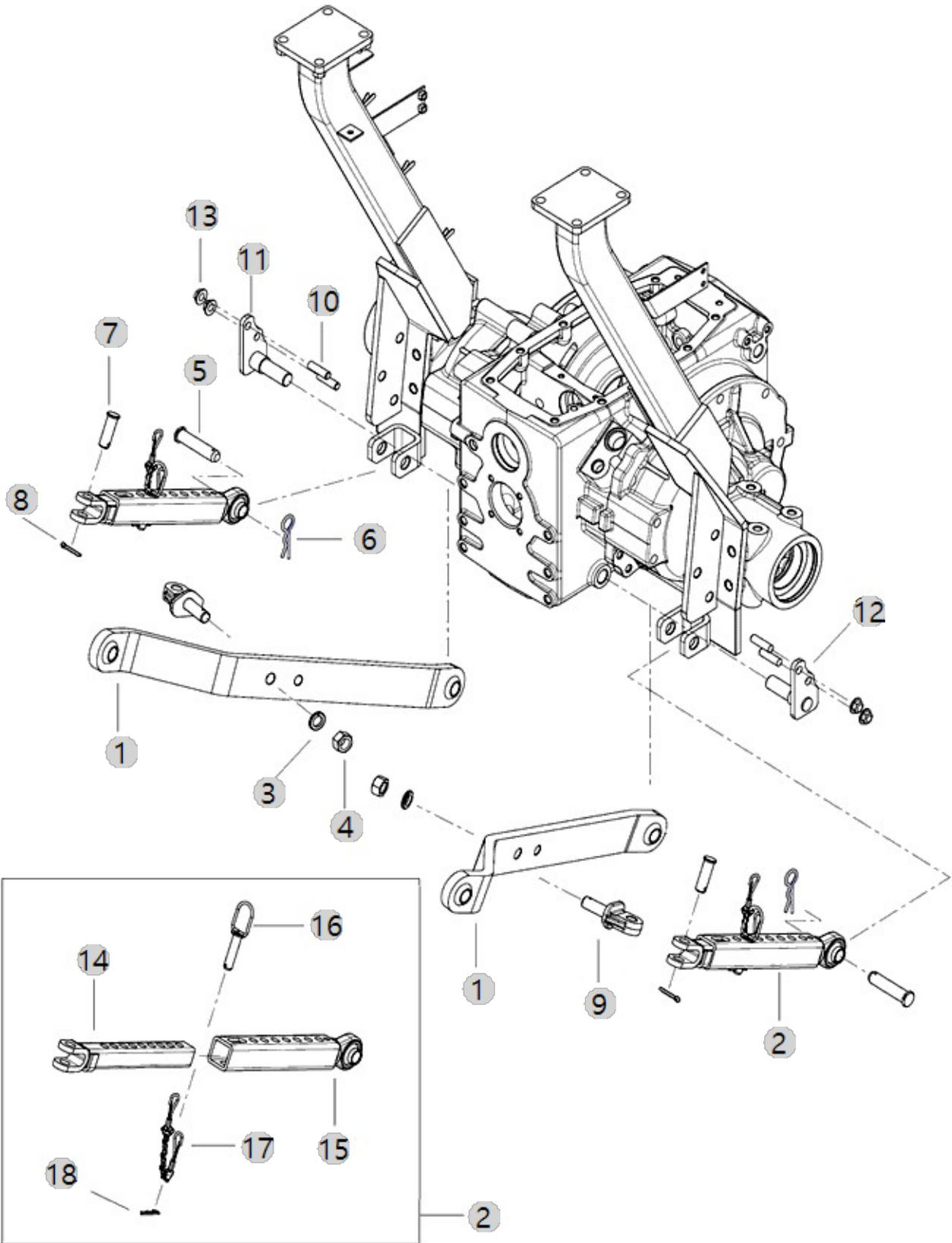



G05050

4815H\_US\_FL  
(AC02166)

LIFT LINK

Year/Month

2022-12-19

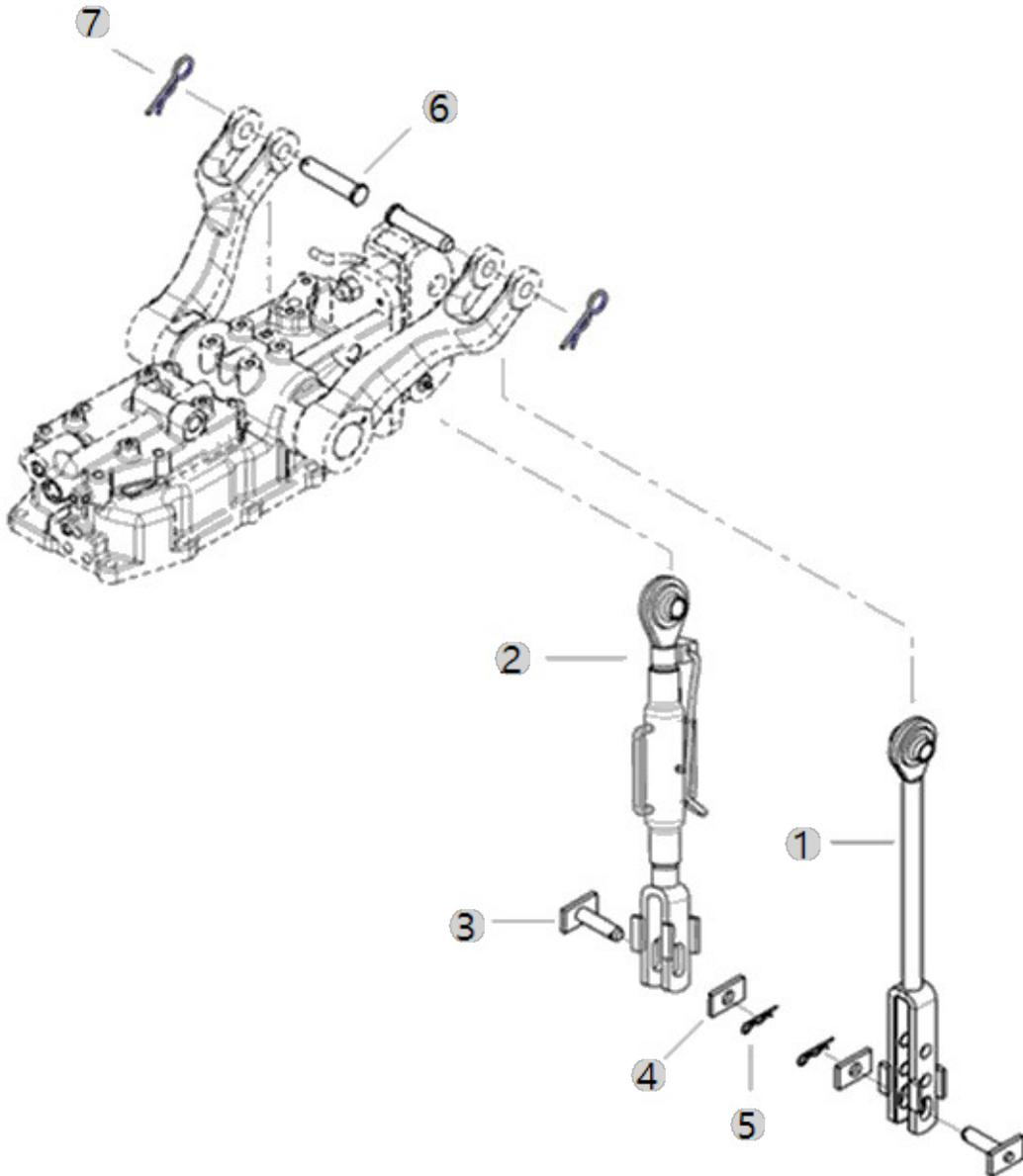



G05070

4815H\_US\_FL  
(AC02166)

### DRAWBAR HITCH

Year/Month

2022-12-19

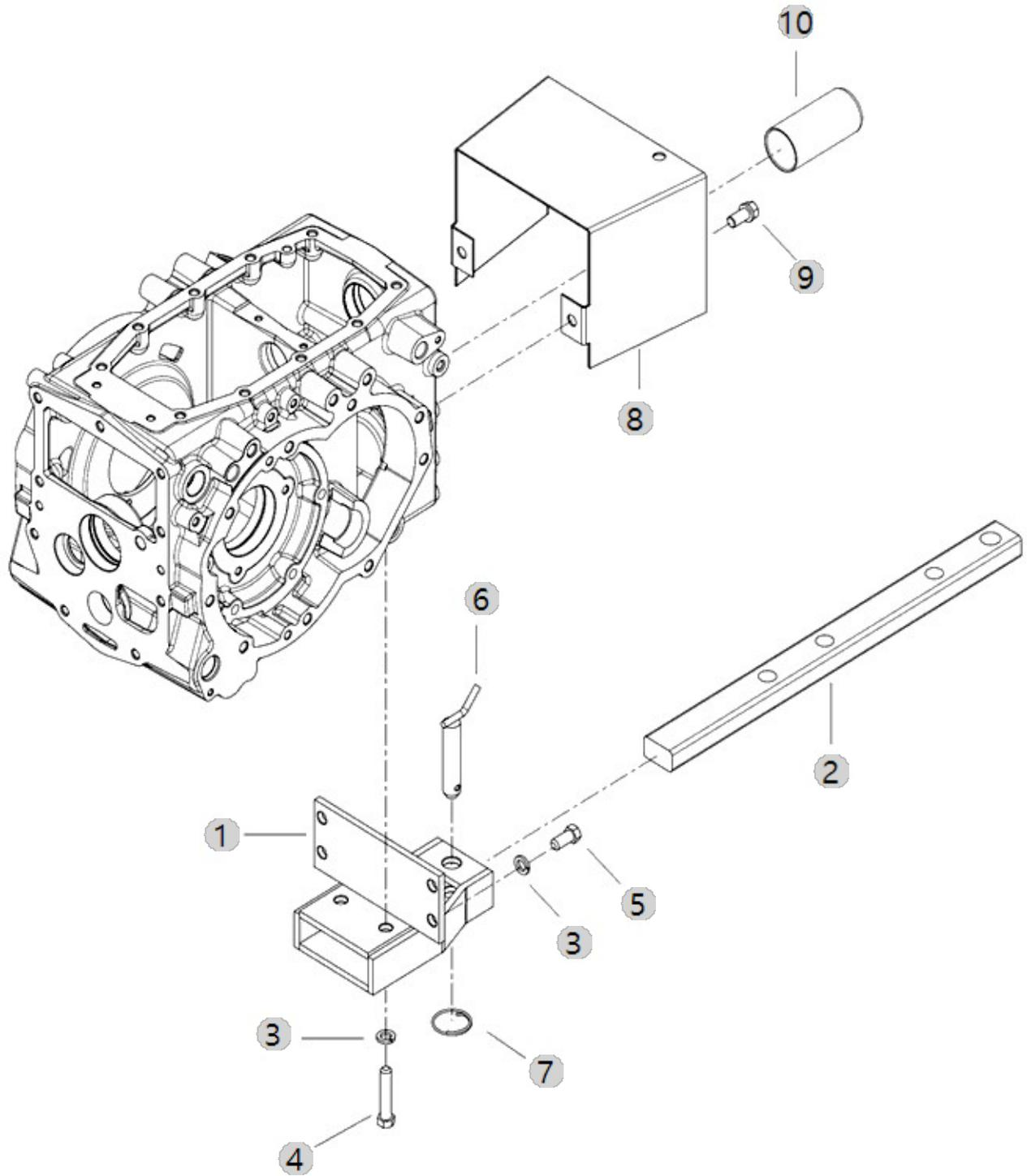



G05090

4815H\_US\_FL  
(AC02166)

### SIDE COVER

Year/Month

2022-12-19

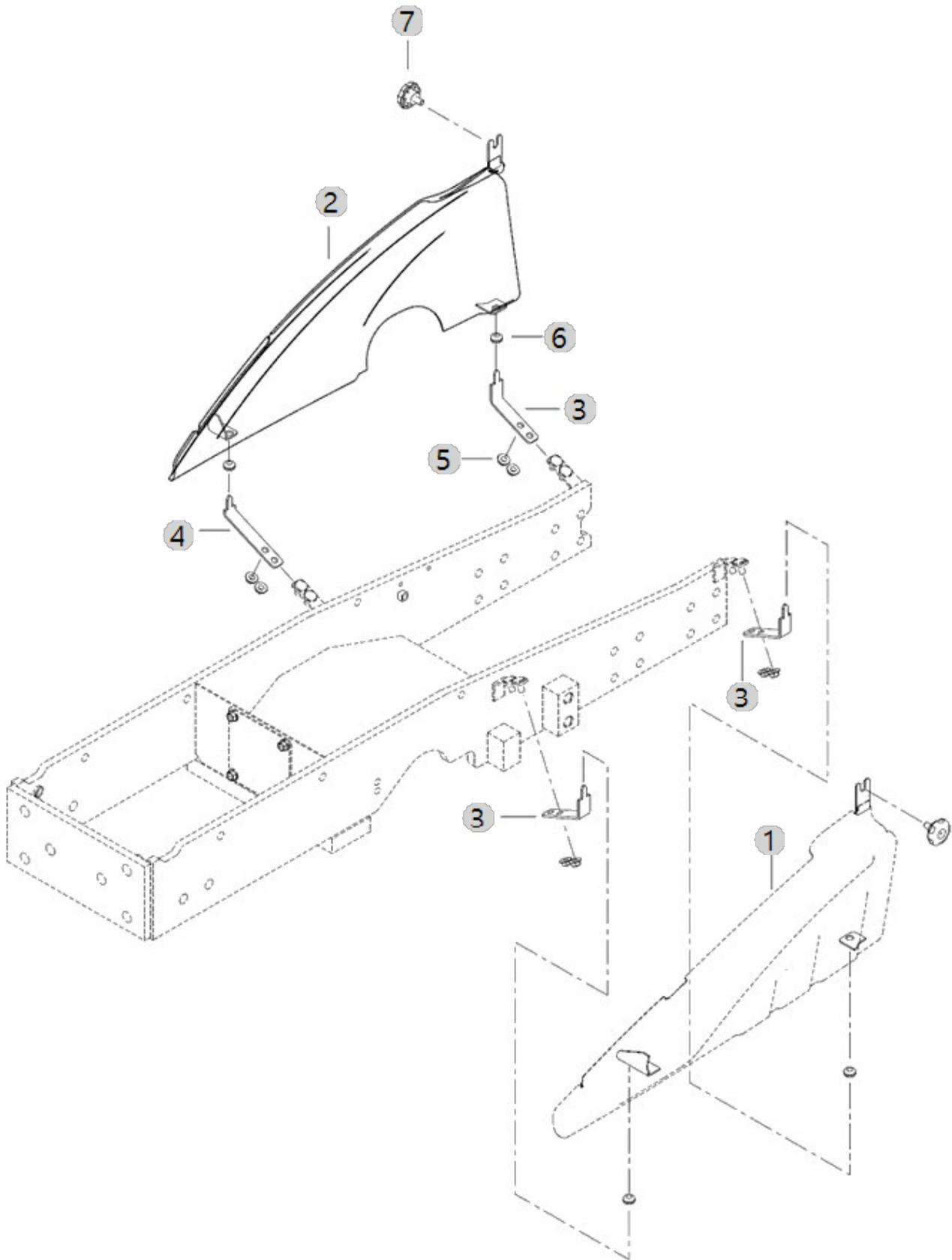





G06010

4815H\_US\_FL  
(AC02166)

TOOL BOX & CUP HOLDER

Year/Month

2022-12-19

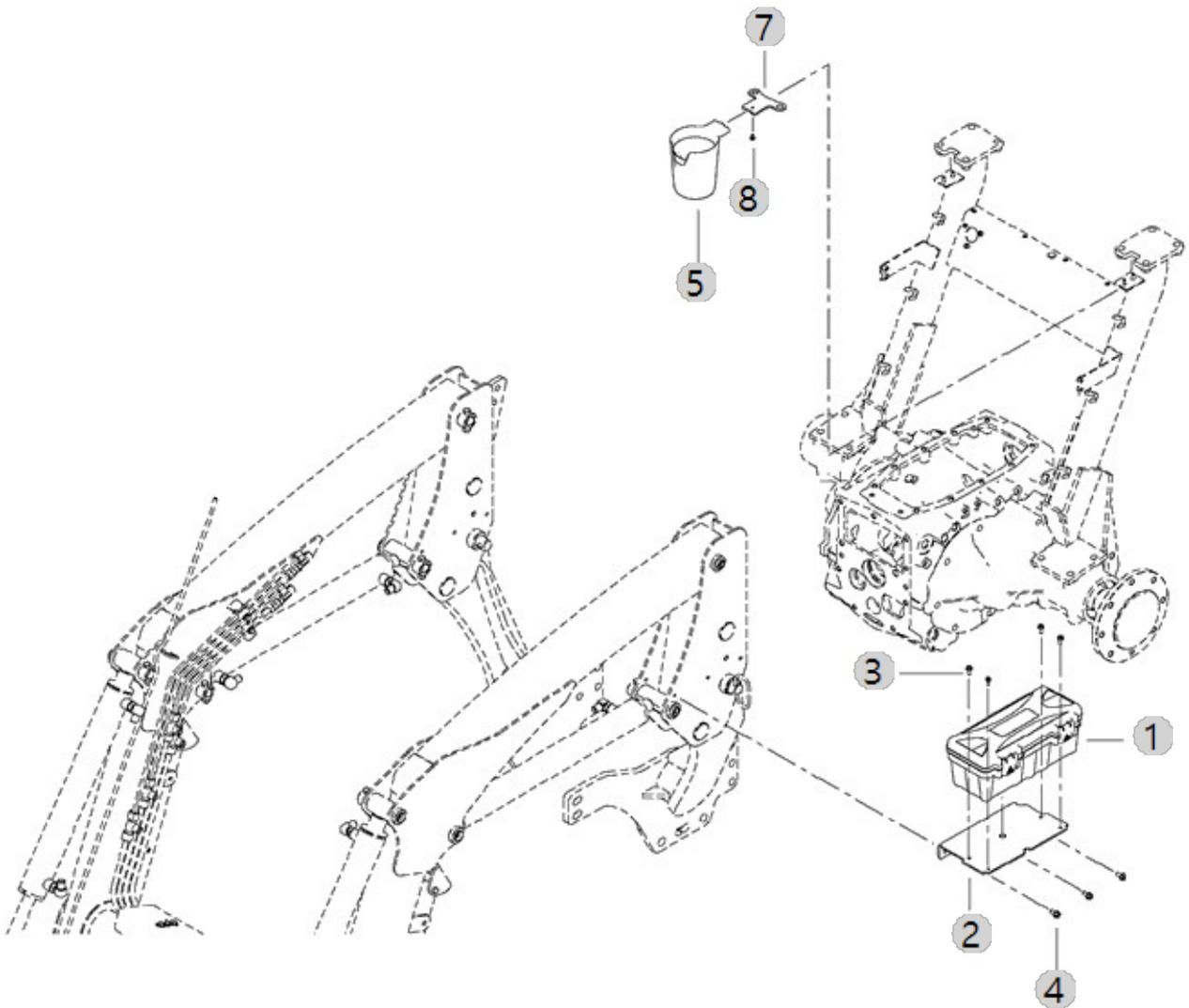



H01030

4815H\_US\_FL  
(AC02166)

BATTERY

Year/Month

2022-12-19

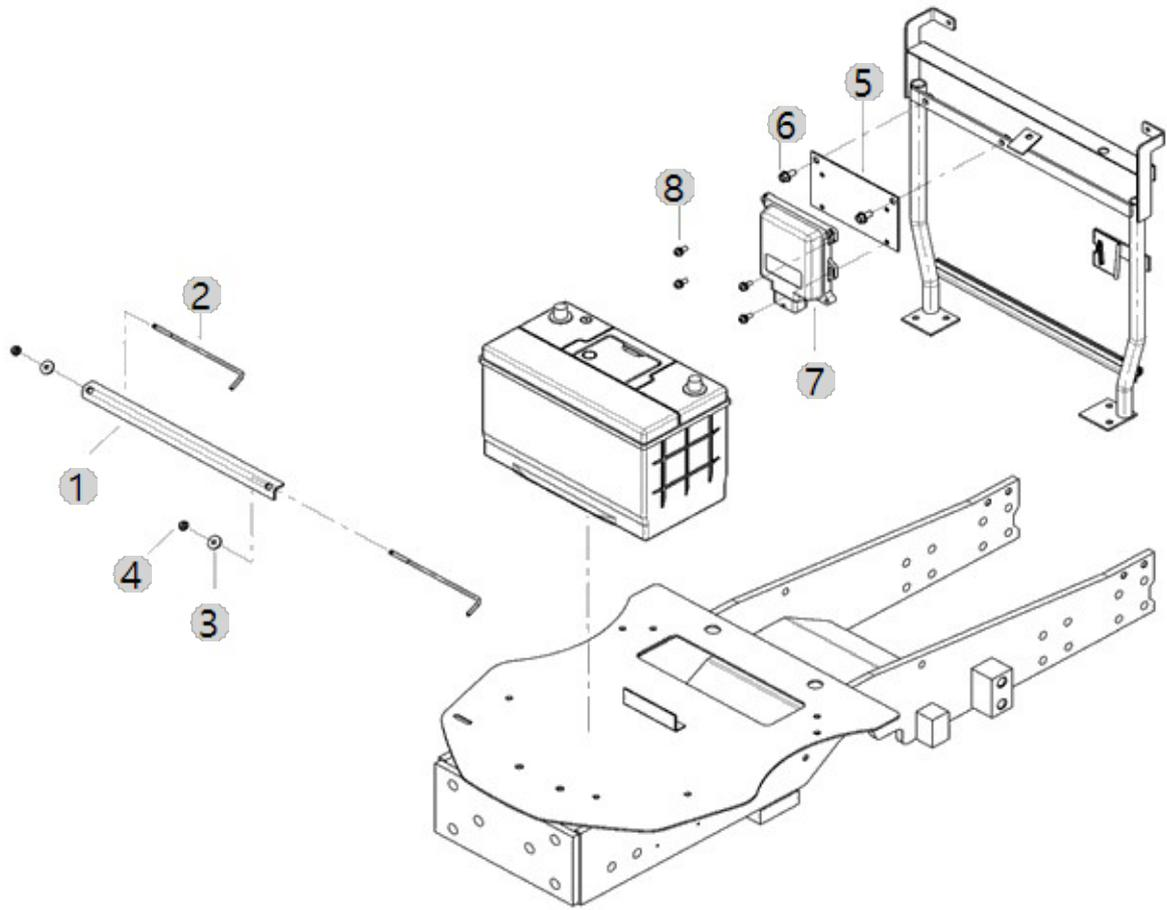



H03000

4815H\_US\_FL  
(AC02166)

ELE'C WIRING

Year/Month

2022-12-19

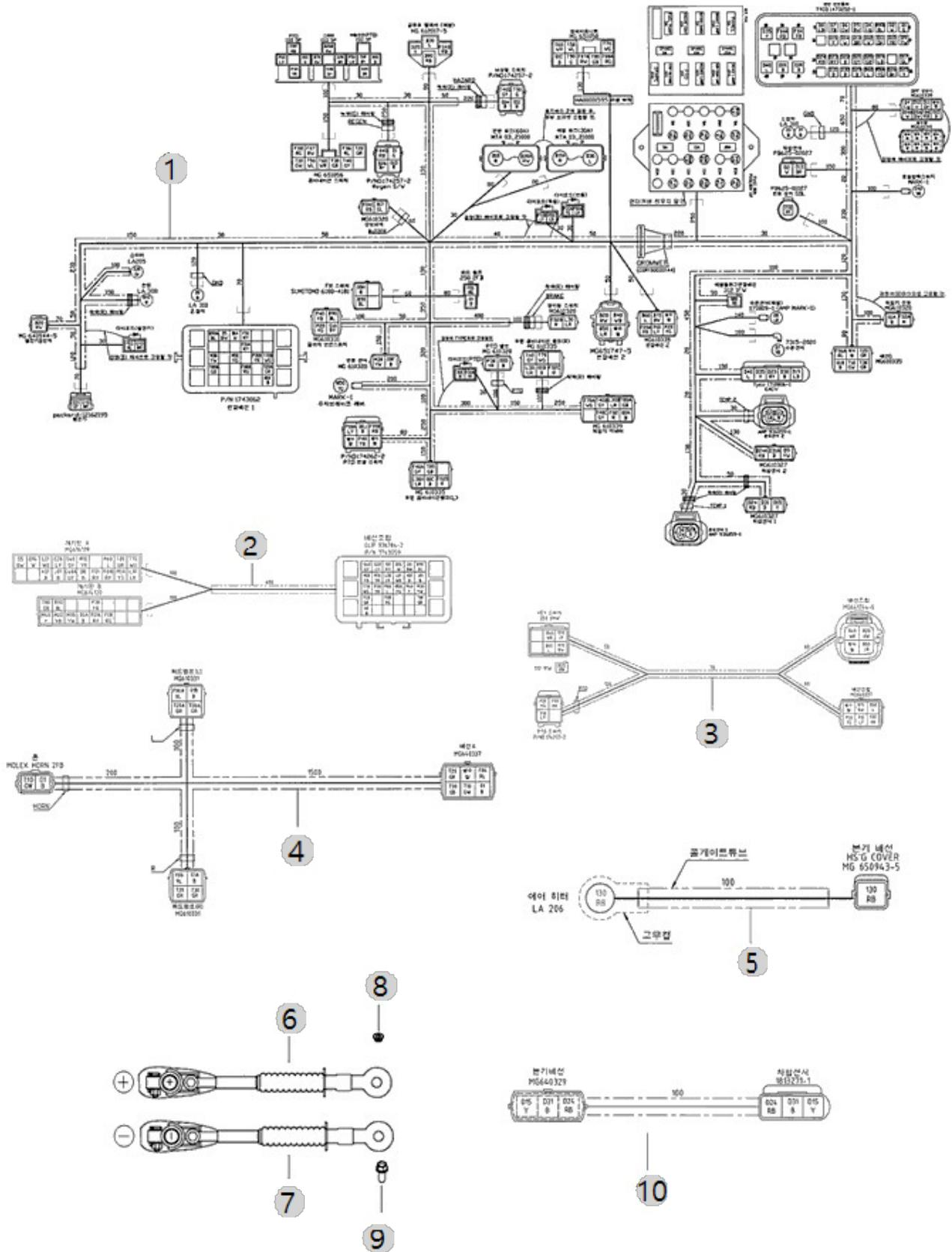



H04051

4815H\_US\_FL  
(AC02166)

SWITCH/DASHBOARD

Year/Month

2022-12-19

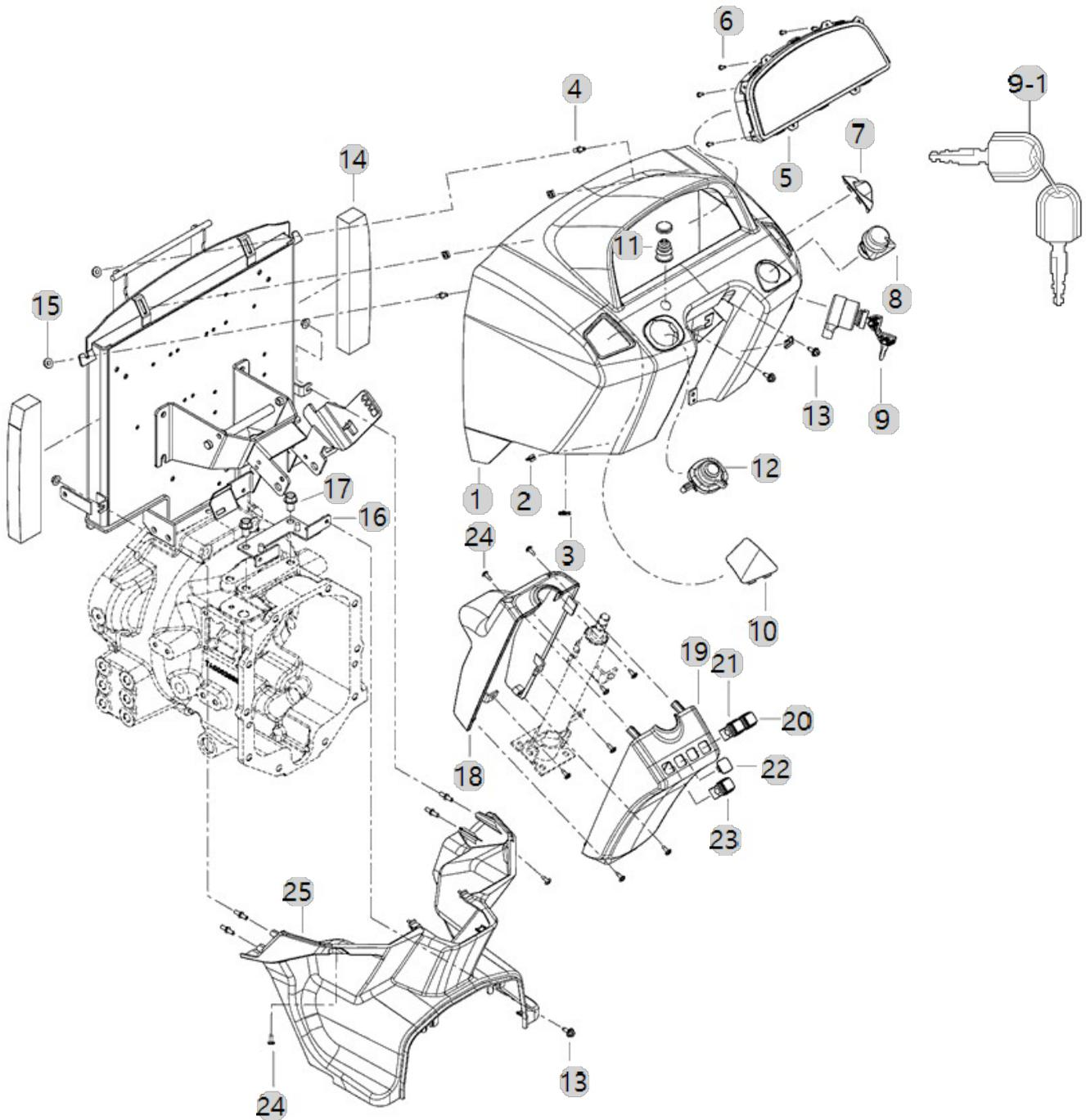





H04070

4815H\_US\_FL  
(AC02166)

# CONTROLLER

Year/Month

2022-12-19

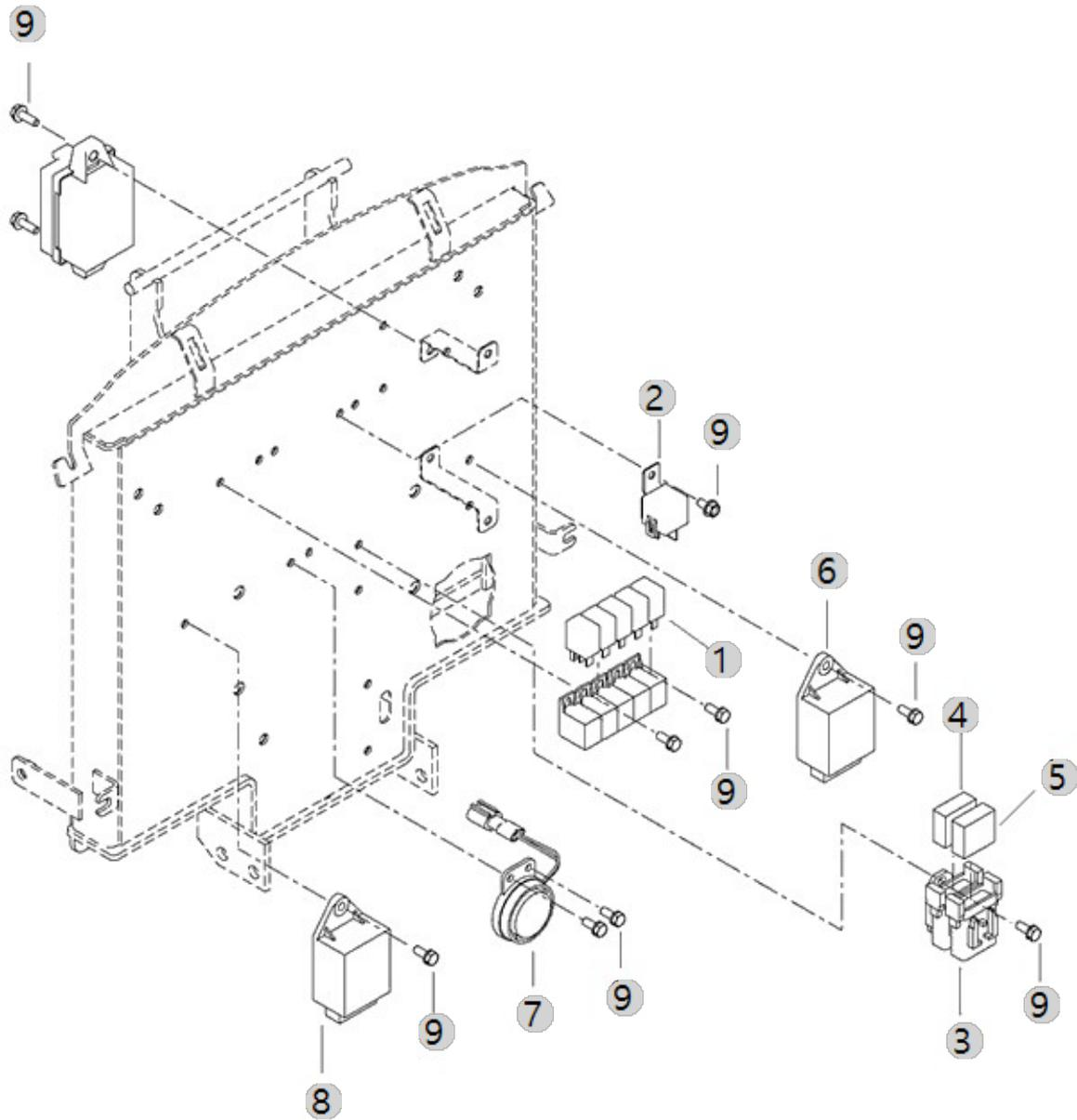



I03000

4815H\_US\_FL  
(AC02166)

NAME PLATE

Year/Month

2022-12-19

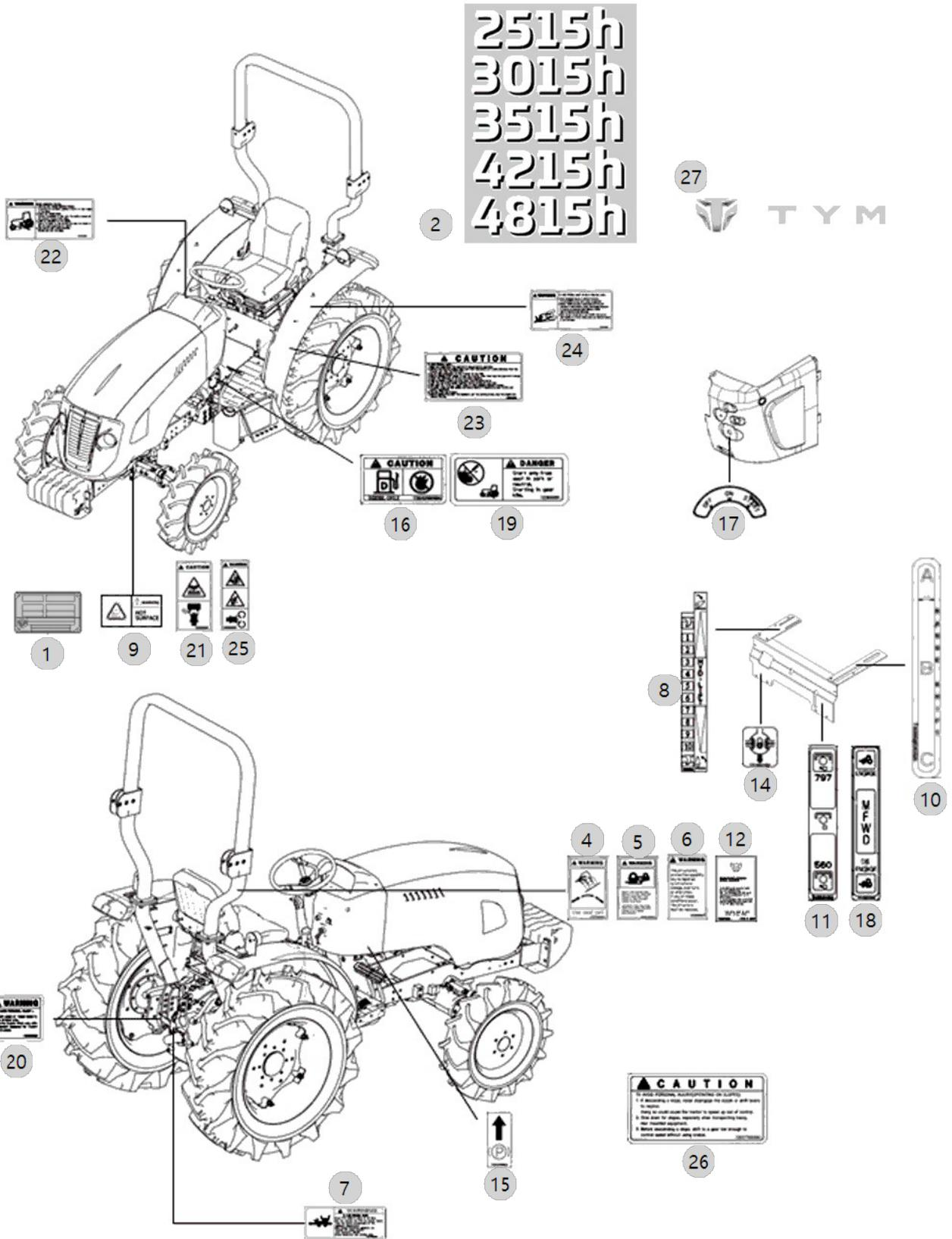



I06010

4815H\_US\_FL  
(AC02166)

SUN VISOR(OPTION)

Year/Month

2022-12-19

