

**T574ST-B**

**Parts Catalog**

# 목 차

---

---

## 0. TRACTOR KIT PART NO. TK1

FIG 000 TRAILER SOCKET KIT	8
FIG 002 3rd FUNCTION KIT , LOADER	10

## 1. Engine PART NO. EG

FIG 100 ENGINE	14
FIG 101 CYLINDER BLOCK	16
FIG 102A OILJET ASS'Y OPTION(T574)	18
FIG 103 CRANK SHAFT	20
FIG 104 PISTON	22
FIG 105 CYLINDER HEAD	24
FIG 106 ROCKER LEVER	26
FIG 107 HEAD COVER	28
FIG 108 GEAR CASE	30
FIG 109 IDLE GEAR	32
FIG 110 CAM SHAFT	34
FIG 111 OIL PUMP	36
FIG 112 HYD. PUMP DRIVE	38
FIG 113 2ND BALANCE	40
FIG 114 OIL PAN	42
FIG 115A INTAKE MANIFOLD(T574)	44
FIG 116A EXHAUST MANIFOLD(T574)	46
FIG 117A TURBOCHARGER ASS'Y(T574)	48
FIG 118A TURBOCHARGER PLUMBING OPTION(T574)	50
FIG 119A BREATHER(T574)	52
FIG 120 FUEL INJECTION PUMP	54
FIG 121 FUEL INJECTION VALVE	56
FIG 122 FUEL PIPE ASS'Y	58
FIG 123 OIL FILTER	60
FIG 124 OIL COOLER	62
FIG 125 OIL GAUGUE	64

FIG 126 OIL FILLER CAP	66
FIG 127 COOLING WATER PUMP	68
FIG 128 CRANK SHAFT PULLEY	70
FIG 129 V-PULLEY	72
FIG 130 COOLING FAN	74
FIG 131 FLYWHEEL HOUSING	76
FIG 132 FLYWHEEL	78
FIG 133 GLOW PLUG ASS'Y OPTION	80
FIG 134 STARTING MOTOR	82
FIG 135 FUEL FILTER BRACKET ASS'Y	84
FIG 136 ALTERNATOR	86
FIG 137 V-BELT	88
FIG 138 FUEL FILTER	90
FIG 139A DPF SUPPORT (T574)	92
FIG 140 DATAPLATE	94
FIG 142A DPF ASS'Y (T574)	96
FIG 143 LIFT ASS'Y	98
FIG 144 COMP . DRIVE PULLEY ASS'Y OPTION	100
FIG 145 INTAKE PIPE	102
FIG 146 CCV ASS'Y	104
FIG 147 LOOSED PARTS	106

## 2. Engine Accessories PART NO. T2

FIG 201A AIR CLEANER (T574)	109
FIG 202 RADIATOR	111
FIG 203 MUFFLER	113
FIG 204 FUEL HOSE & FILTER	115
FIG 205 FUEL TANK	117
FIG 206 ACCELERATOR	119

## 3. Clutch/Brake/Steering PART NO. T3

FIG 301 CLUTCH	122
FIG 302 CLUTCH PEDAL	124
FIG 303 BRAKE	127
FIG 304 BRAKE PEDAL & LINK	129
FIG 305 FRONT WHEEL	131

FIG 306 REAR WHEEL	133
FIG 307 POWER STEERING WHEEL	135
FIG 308 POWER STEERING VALVE	137
FIG 309 POWER STEERING CYLINDER	139

#### 4. Transmission PART NO. T4

FIG 401 TRANSMISSION FRONT CASE	142
FIG 402 FORWARD & BACKWARD GEARS	144
FIG 403 IDLE & COUNTER GEARS	146
FIG 404 MAIN SHIFT GEARS	148
FIG 405 P.T.O DRIVE SHAFT	150
FIG 406 MAIN CHANGE LEVER	152
FIG 407 REVERSE CHANGE LEVER	154
FIG 408 TRANSMISSION MID CASE	156
FIG 409 TRANSMISSION REAR CASE	158
FIG 410 SUB CHANGE GEARS	160
FIG 411 SUB CHANGE SHIFTER	162
FIG 413 DRIVE GEARS	164
FIG 414 4WD CHANGE LEVER	166
FIG 415 P.T.O CHANGE GEARS	168
FIG 417 REAR DIFFERENTIAL GEARS	170
FIG 418 REAR AXLE HOUSING	173

#### 5. Front Axle PART NO. T5

FIG 501 FRONT AXLE SUPPORT	176
FIG 502 FRONT DRIVE SHAFT	178
FIG 503 FRONT AXLE HOUSING	180
FIG 504 FRONT DIFFERENTIAL GEARS	182
FIG 505 FRONT GEAR CASE (1)	184
FIG 506 FRONT GEAR CASE (2)	186
FIG 507 FRONT GEAR CASE (3)	188

#### 6. Hydraulic/3P-Link PART NO. T6

FIG 601 CYLINDER CASE	191
FIG 602 LIFT ARM	193

FIG 603 CYLINDER	195
FIG 604 POSITION LINK	197
FIG 605 CONTROL VALVE	199
FIG 606 DRAFT LINK	201
FIG 607A POSITION & DRAFT LEVER (1)	203
FIG 607B POSITION & DRAFT LEVER (2)	205
FIG 608 EXTERIOR HYD. VALVE	207
FIG 609 HYDRAULIC PIPE	209
FIG 610 JOYSTICK[SAP 가져오기]에서 생성함.	211
FIG 610 JOYSTICK	213
FIG 612 HITCH & 3-POINT LINK	215
FIG 613 LOWER LINK & LIFT ROD	218

## 7. Sheet Metal & Cabin PART NO. T7

FIG 701 BONNET FRAME	221
FIG 702A BONNET (1)	223
FIG 702B BONNET (2)	225
FIG 703 EXTENSION COVER	227
FIG 704A LEVER COVER & STEP	229
FIG 705 FRONT & REAR MOUNTING[SAP 가져오기]에서 생성함.	231
FIG 705 FRONT & REAR MOUNTING	233
FIG 706 SEAT & MAT	235
FIG 709 DOOR	237
FIG 710A FRONT GLASS	240
FIG 711 SIDE GLASS	242
FIG 712 REAR GLASS	244
FIG 713A SUB FENDER & COVER	246
FIG 714A MIRROR	248
FIG 715A HEATER & AIR-CON	250
FIG 715B HEATER & AIR-CON	252
FIG 716 FENDER COVER	254
FIG 717 ROOF	256
FIG 718 CABIN INTERIOR	258

## 8. Electrical System PART NO. T8

FIG 801 BATTERY & MOUNTING	261
----------------------------	-----

FIG 802 HARNESS LAMP	263
FIG 803 INSTRUMENT PANEL	265
FIG 804 ELECTRIC SYSTEM (1)	267
FIG 805A ELECTRIC SYSTEM (2)	269
FIG 806 ELECTRIC SYSTEM (3)	271

## 9. Label/Option PART NO. T9

FIG 901 TOOL & ACCESSORY	274
FIG 902 LABEL	276
FIG 902 LABEL	278

# 0. TRACTOR KIT PART NO. TK1

FIG 000 TRAILER SOCKET KIT

8

FIG 002 3rd FUNCTION KIT , LOADER

10

FIG 000 T574ST-B	TRAILER SOCKET KIT	년/월 Year/Month 2022-12
---------------------	--------------------	------------------------------

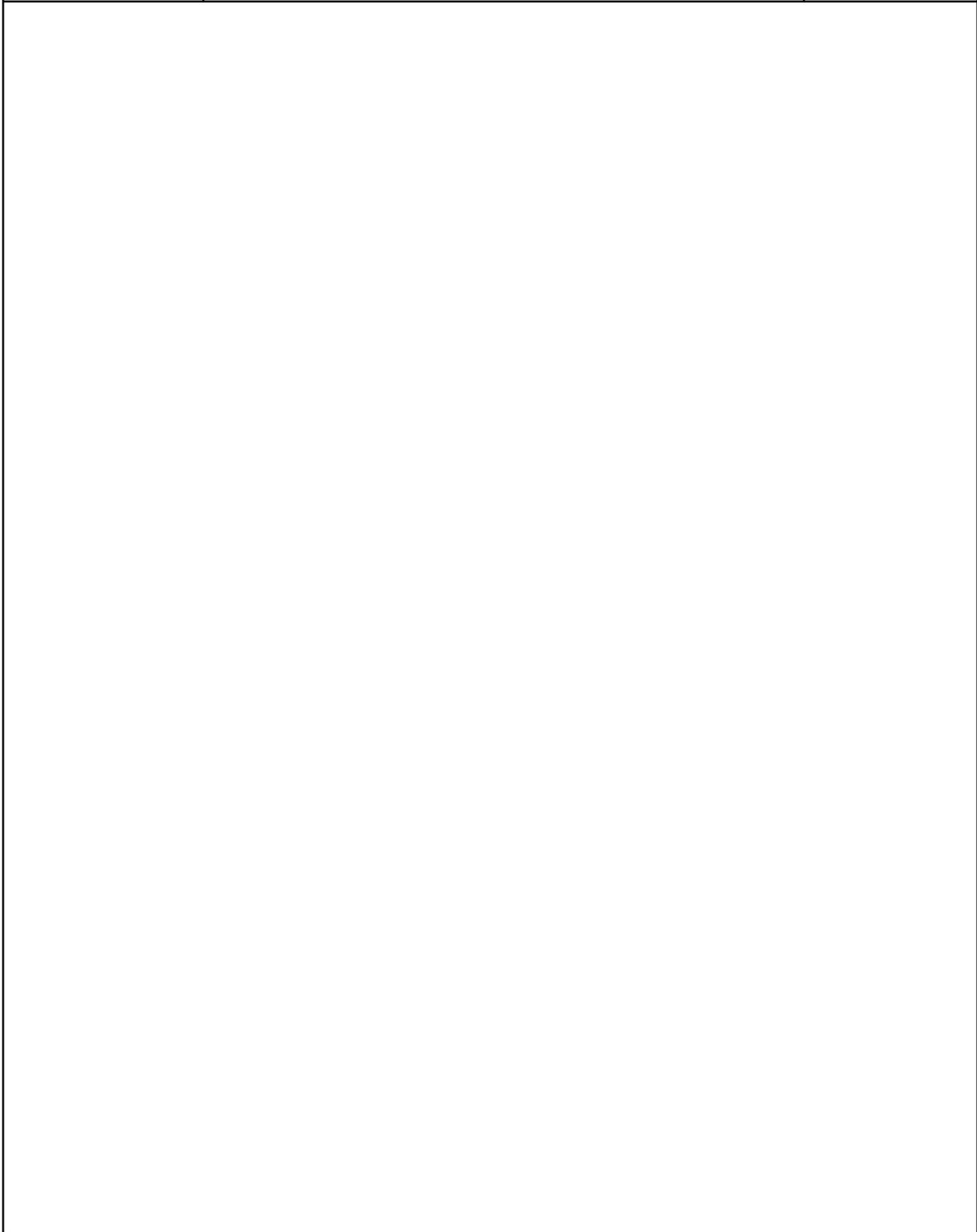

NOTE	
------	--





FIG 002 T574ST-B	3rd FUNCTION KIT , LOADER	년/월 Year/Month 2022-12
---------------------	---------------------------	------------------------------

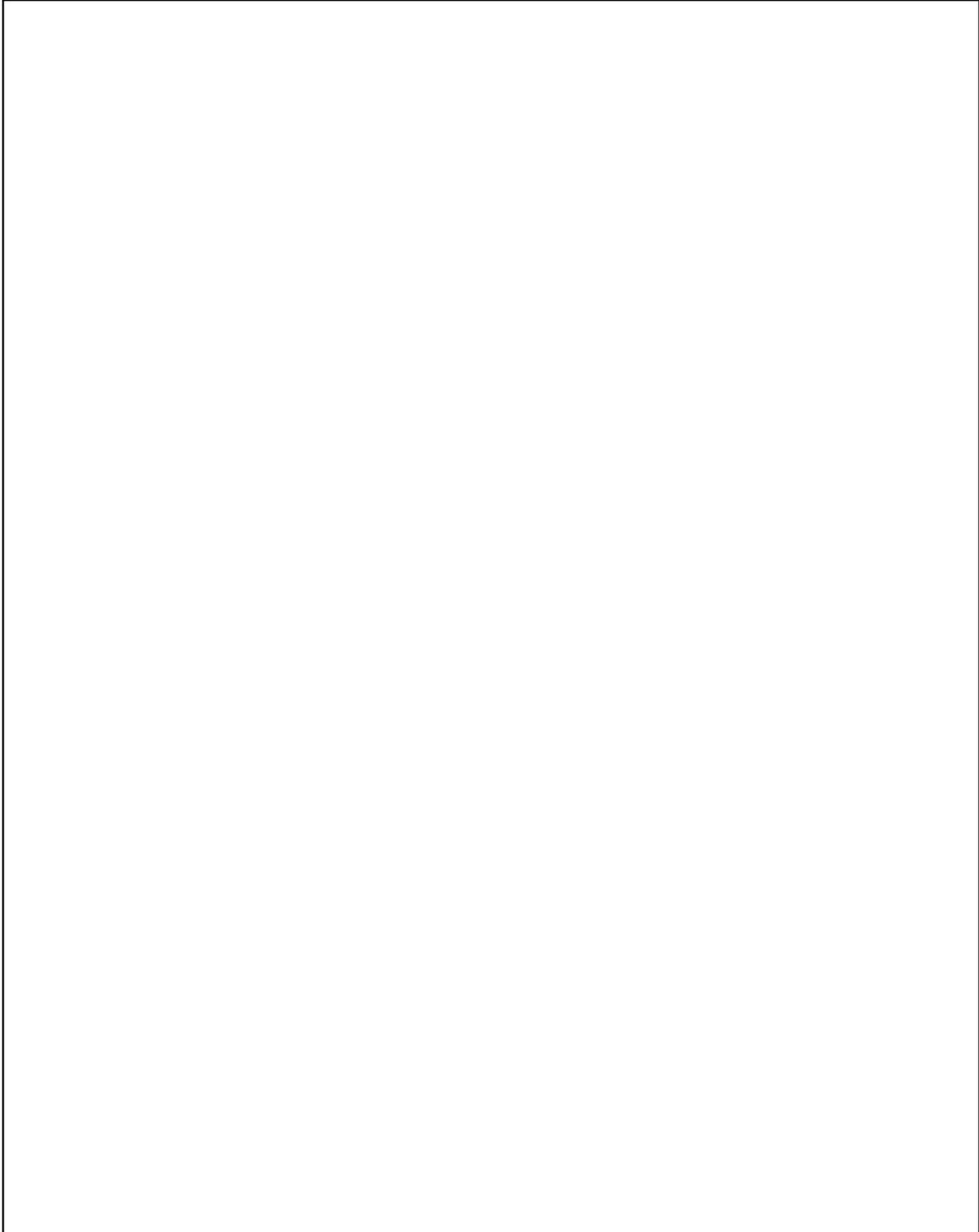

NOTE	
------	--



## 1. Engine PART NO. EG

FIG 100 ENGINE	14
FIG 101 CYLINDER BLOCK	16
FIG 102A OILJET ASS'Y OPTION(T574)	18
FIG 103 CRANK SHAFT	20
FIG 104 PISTON	22
FIG 105 CYLINDER HEAD	24
FIG 106 ROCKER LEVER	26
FIG 107 HEAD COVER	28
FIG 108 GEAR CASE	30
FIG 109 IDLE GEAR	32
FIG 110 CAM SHAFT	34
FIG 111 OIL PUMP	36
FIG 112 HYD. PUMP DRIVE	38
FIG 113 2ND BALANCE	40
FIG 114 OIL PAN	42
FIG 115A INTAKE MANIFOLD(T574)	44
FIG 116A EXHAUST MANIFOLD(T574)	46
FIG 117A TURBOCHARGER ASS'Y(T574)	48
FIG 118A TURBOCHARGER PLUMBING OPTION(T574)	50
FIG 119A BREATHER(T574)	52
FIG 120 FUEL INJECTION PUMP	54
FIG 121 FUEL INJECTION VALVE	56
FIG 122 FUEL PIPE ASS'Y	58
FIG 123 OIL FILTER	60
FIG 124 OIL COOLER	62
FIG 125 OIL GAUGUE	64
FIG 126 OIL FILLER CAP	66
FIG 127 COOLING WATER PUMP	68
FIG 128 CRANK SHAFT PULLEY	70
FIG 129 V-PULLEY	72
FIG 130 COOLING FAN	74
FIG 131 FLYWHEEL HOUSING	76
FIG 132 FLYWHEEL	78
FIG 133 GLOW PLUG ASS'Y OPTION	80
FIG 134 STARTING MOTOR	82
FIG 135 FUEL FILTER BRACKET ASS'Y	84
FIG 136 ALTERNATOR	86
FIG 137 V-BELT	88

FIG 138 FUEL FILTER	90
FIG 139A DPF SUPPORT (T574)	92
FIG 140 DATAPLATE	94
FIG 142A DPF ASS'Y (T574)	96
FIG 143 LIFT ASS'Y	98
FIG 144 COMP . DRIVE PULLEY ASS'Y OPTION	100
FIG 145 INTAKE PIPE	102
FIG 146 CCV ASS'Y	104
FIG 147 LOOSED PARTS	106

FIG 100 T574ST-B	ENGINE	년/월 Year/Month
		2022-12

--	--

NOTE	
------	--



FIG 101

T574ST-B

CYLINDER BLOCK

년/월  
Year/Month

2022-12

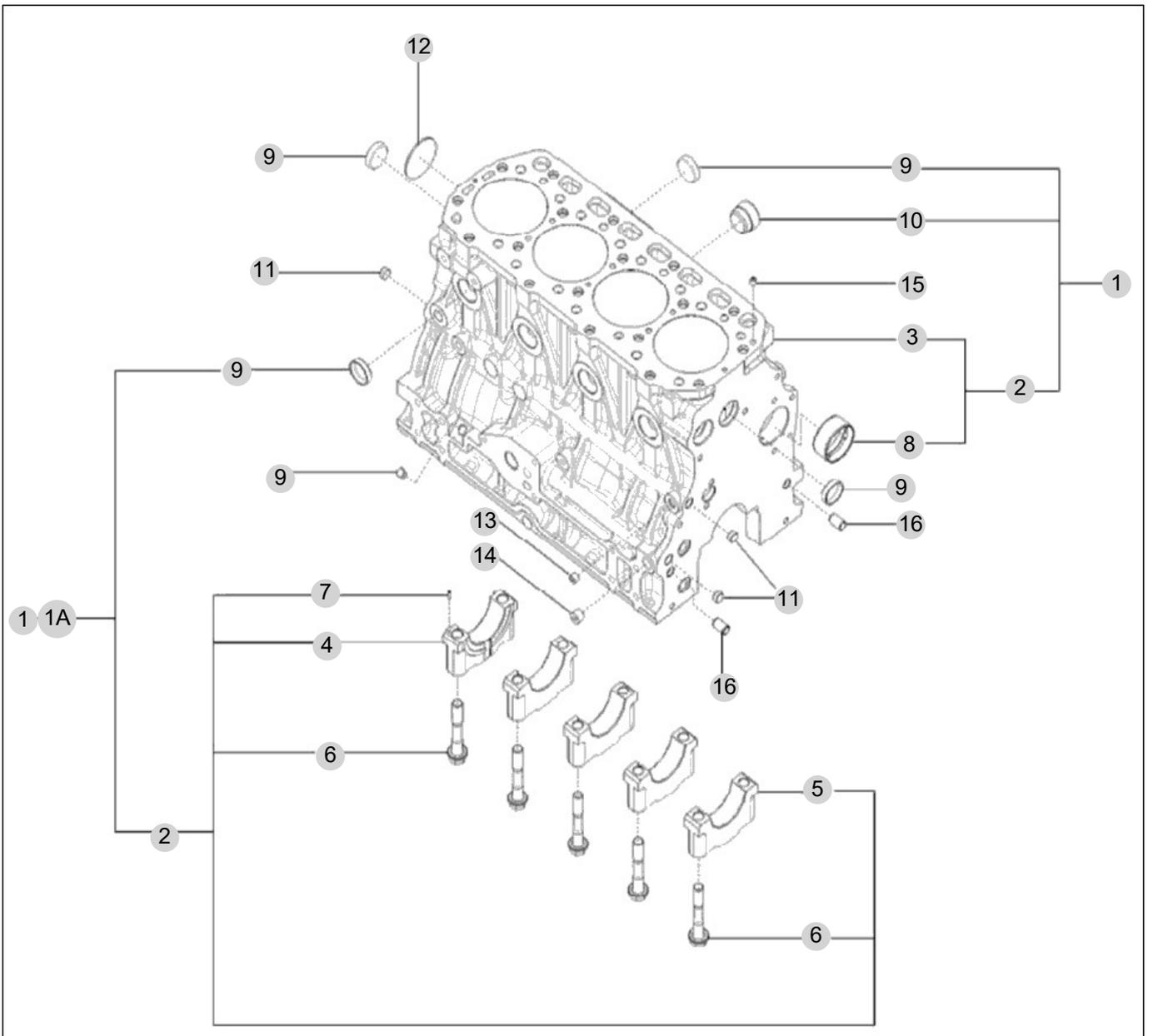

NOTE





FIG 102A

OILJET ASS'Y OPTION(T574)

년/월  
Year/Month

2022-12

T574ST-B

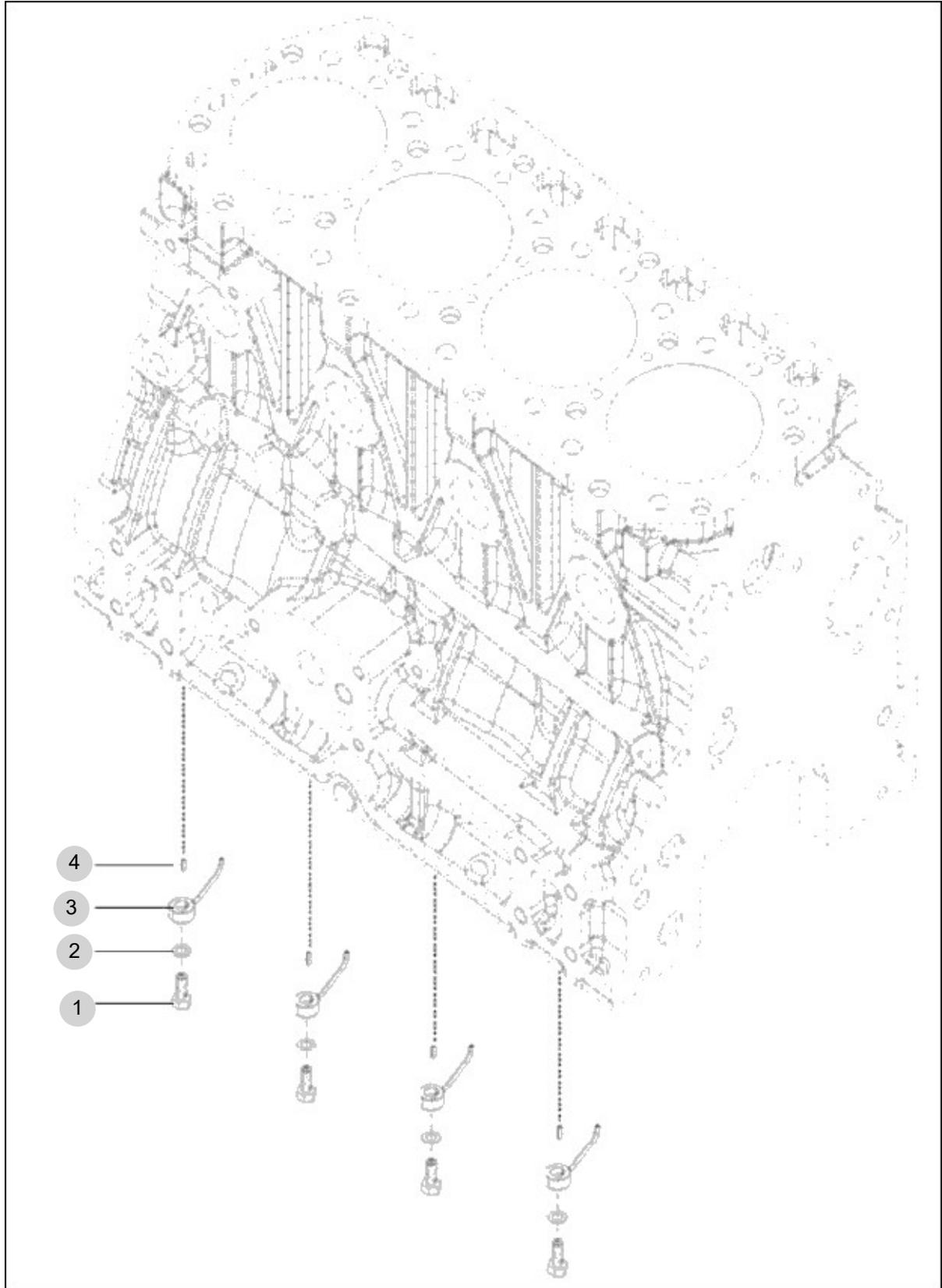

NOTE



FIG 103

CRANK SHAFT

년/월  
Year/Month

T574ST-B

2022-12

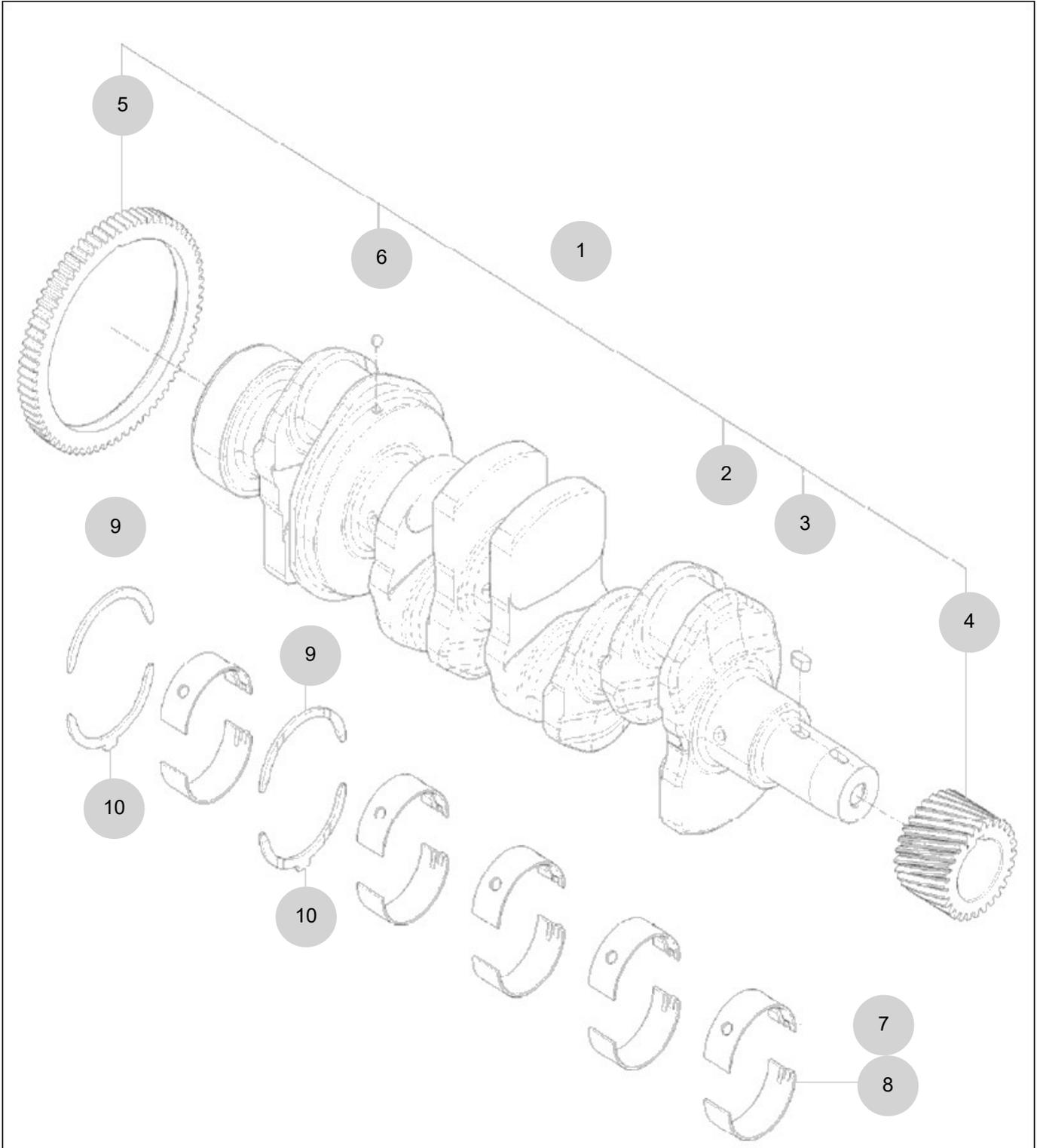

NOTE



FIG 104

T574ST-B

PISTON

년/월  
Year/Month

2022-12

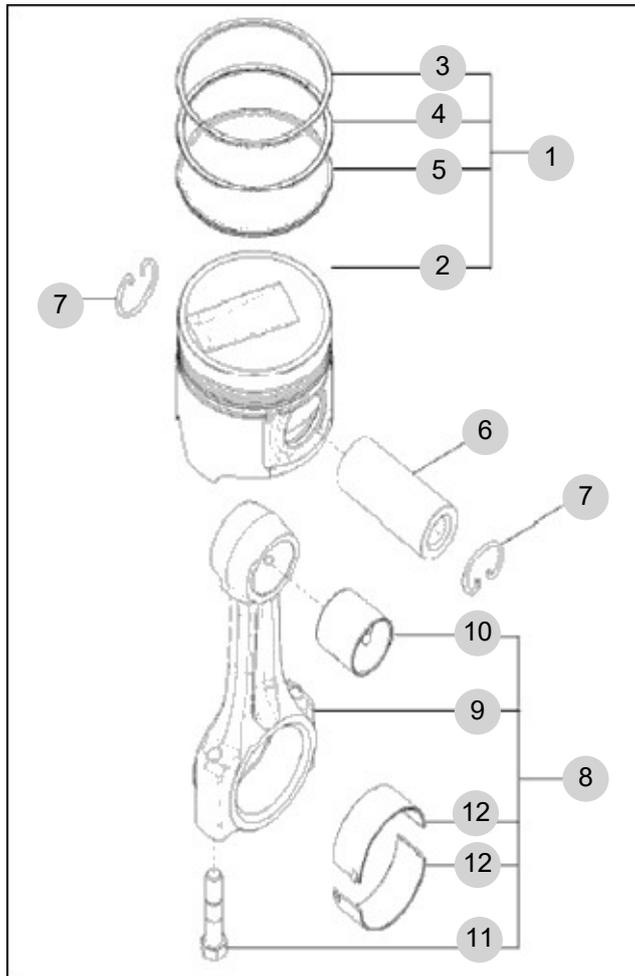

NOTE



FIG 105

CYLINDER HEAD

년/월  
Year/Month

T574ST-B

2022-12

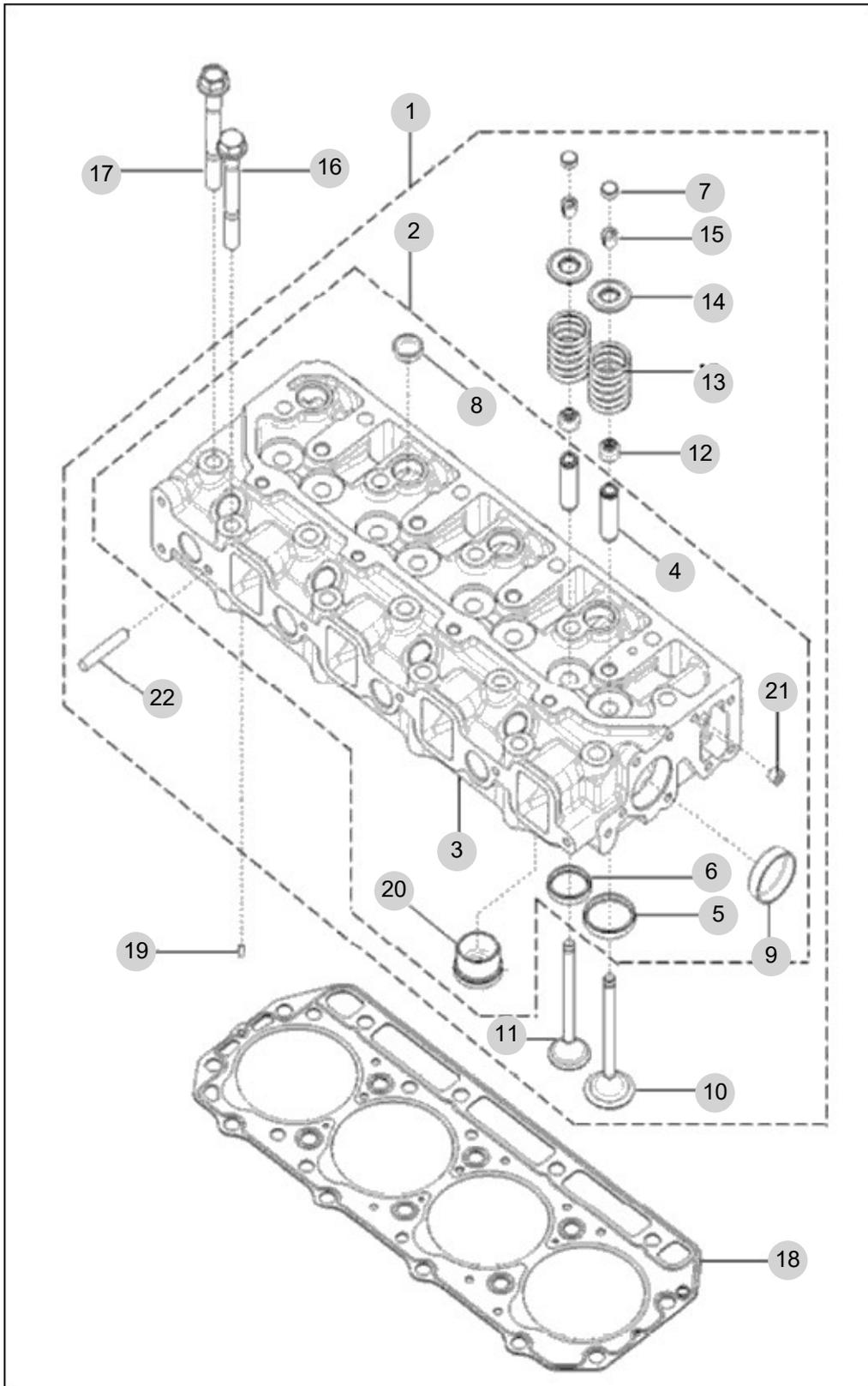

NOTE





FIG 106

T574ST-B

ROCKER LEVER

년/월  
Year/Month

2022-12

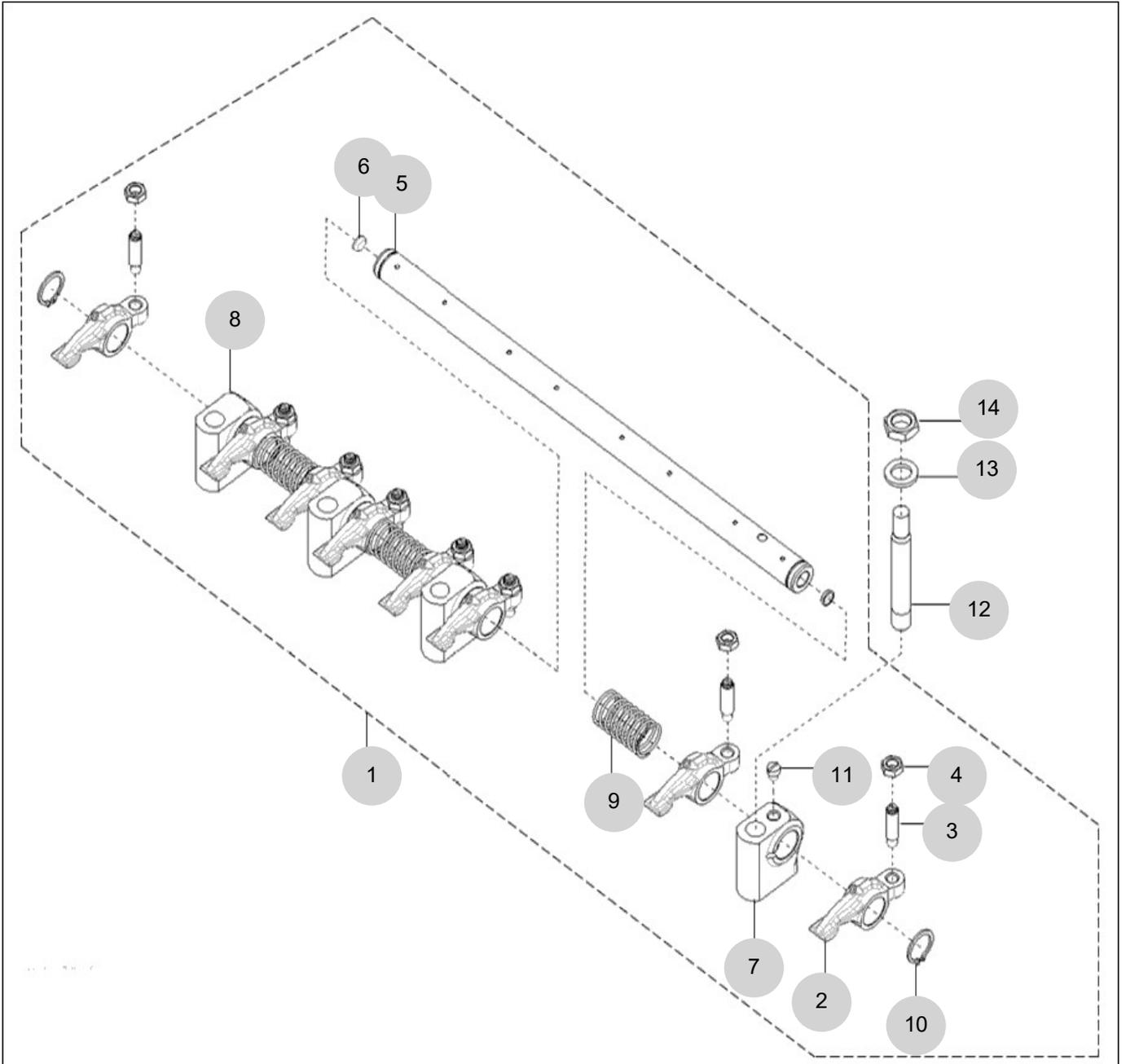

NOTE



FIG 107

T574ST-B

HEAD COVER

년/월  
Year/Month

2022-12

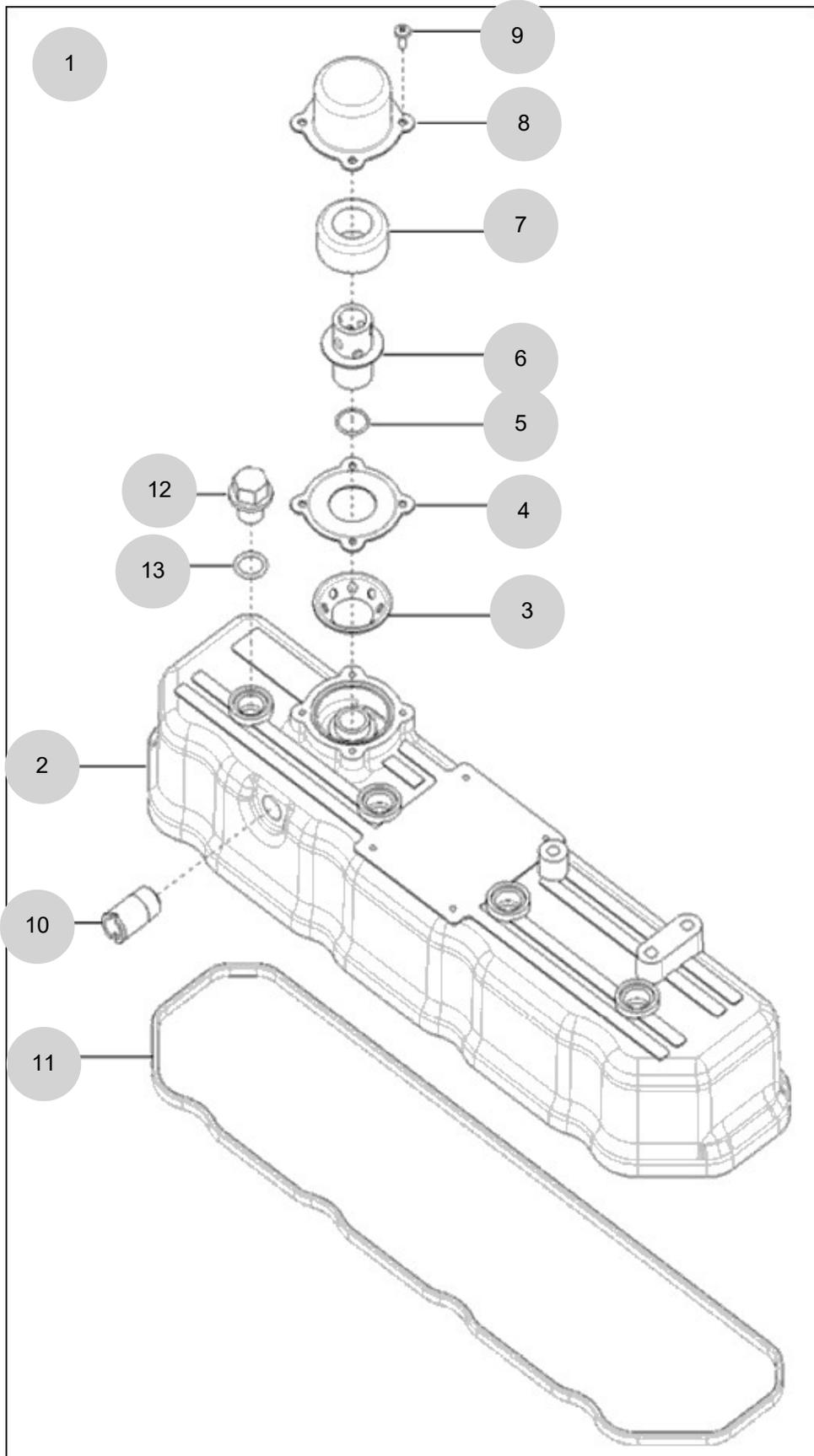

NOTE



FIG 108

GEAR CASE

년/월  
Year/Month

T574ST-B

2022-12

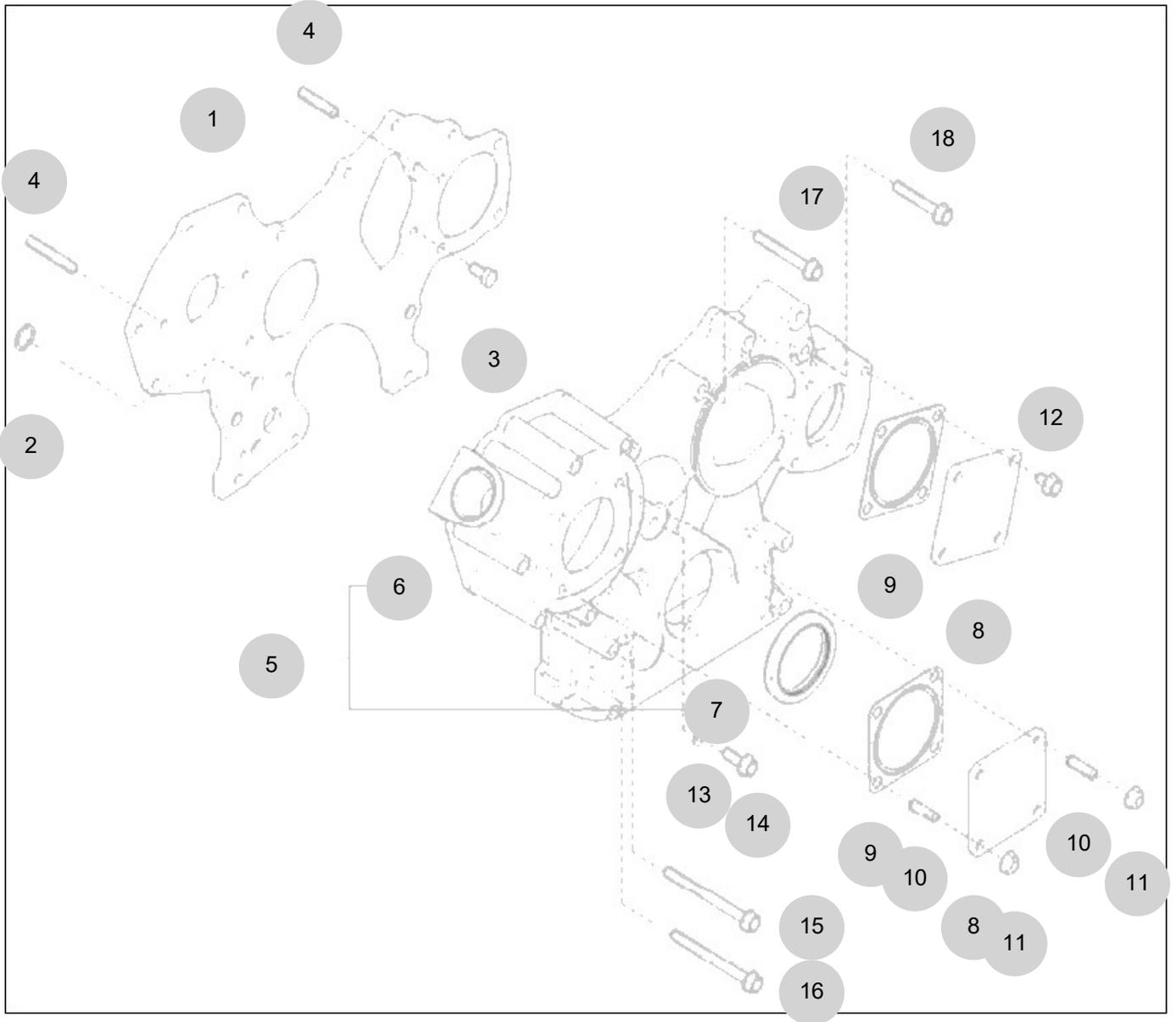

NOTE



FIG 109

IDLE GEAR

년/월  
Year/Month

T574ST-B

2022-12

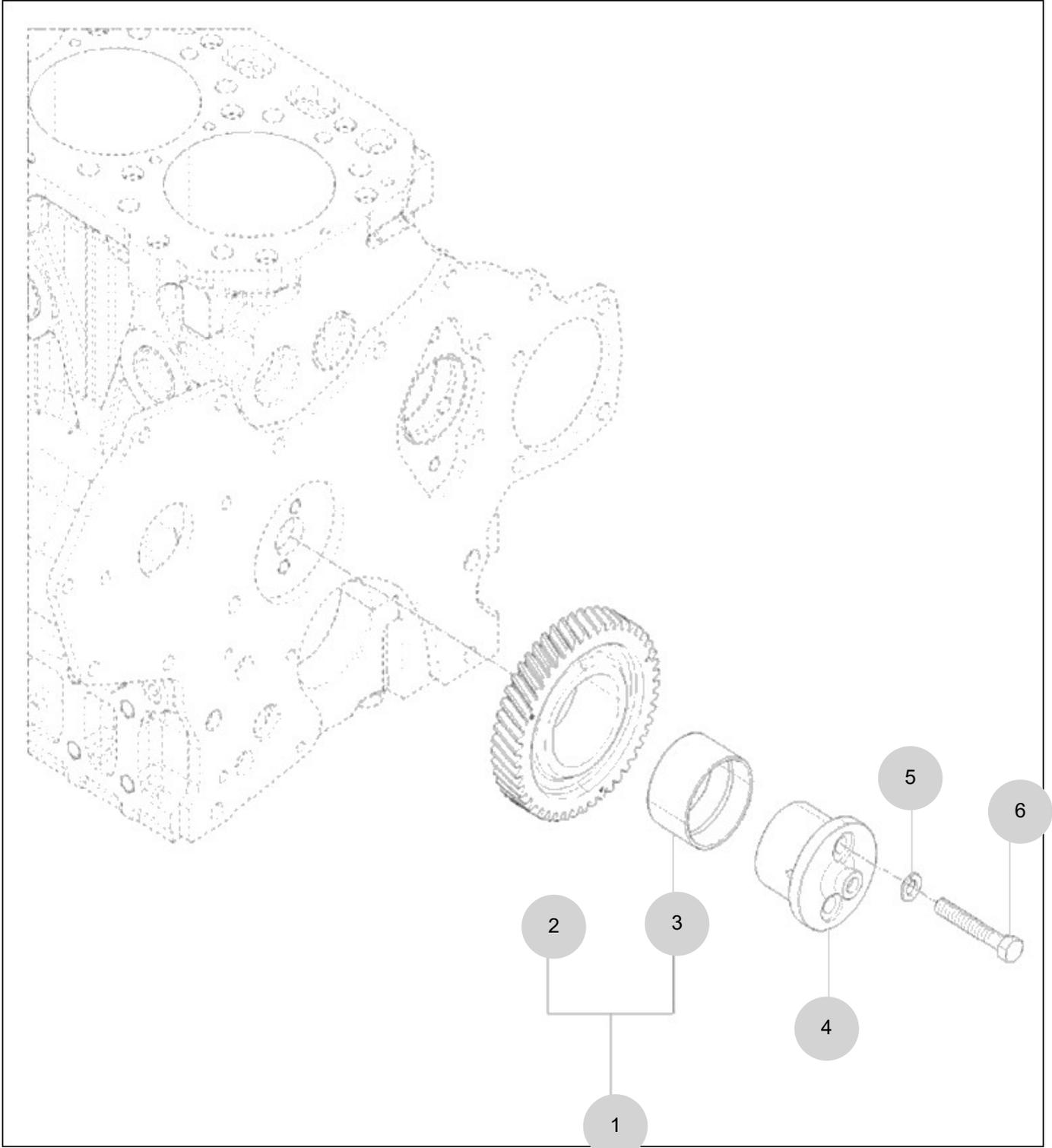

NOTE





FIG 110

T574ST-B

CAM SHAFT

년/월  
Year/Month

2022-12

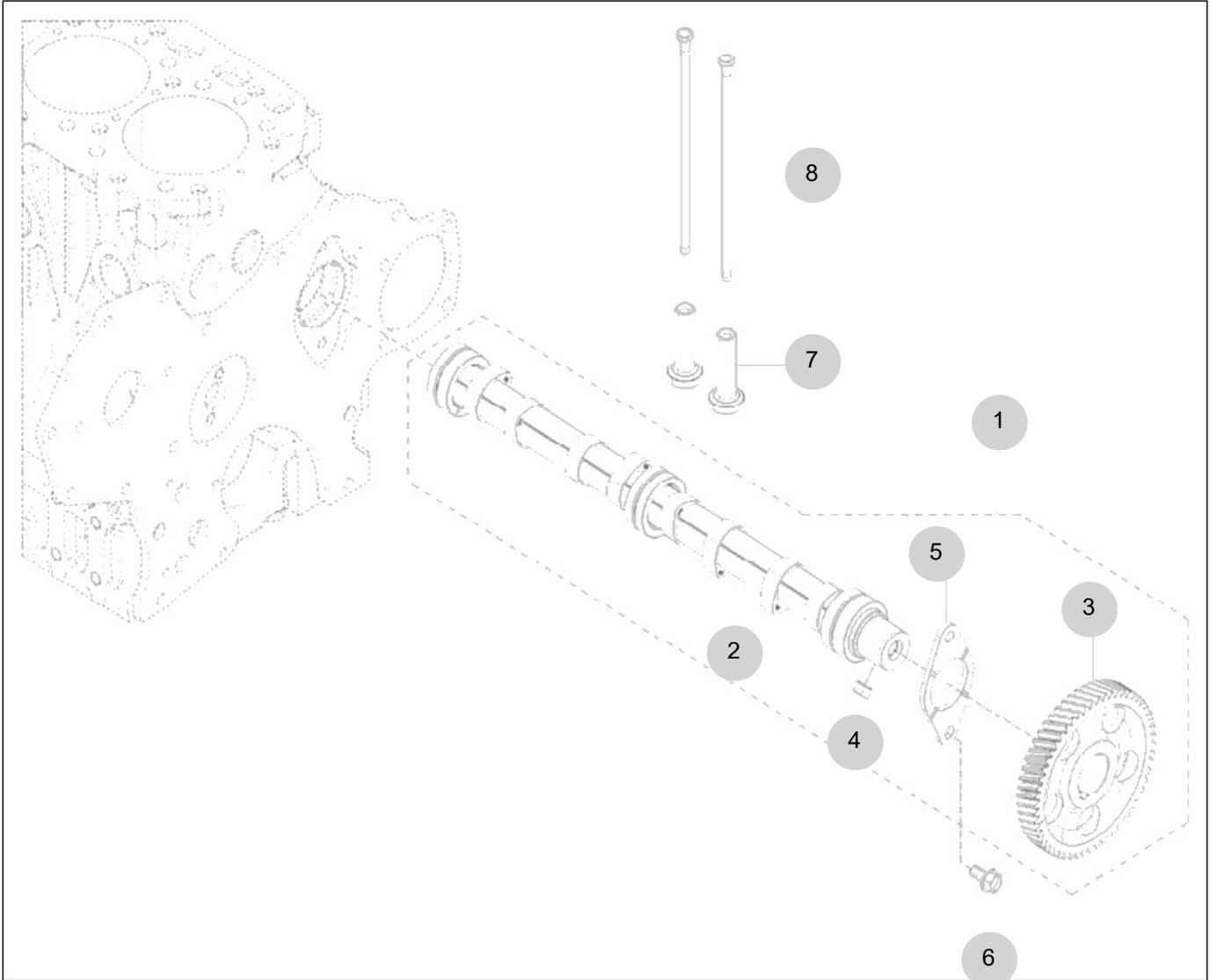

NOTE



FIG 111

OIL PUMP

년/월  
Year/Month

T574ST-B

2022-12

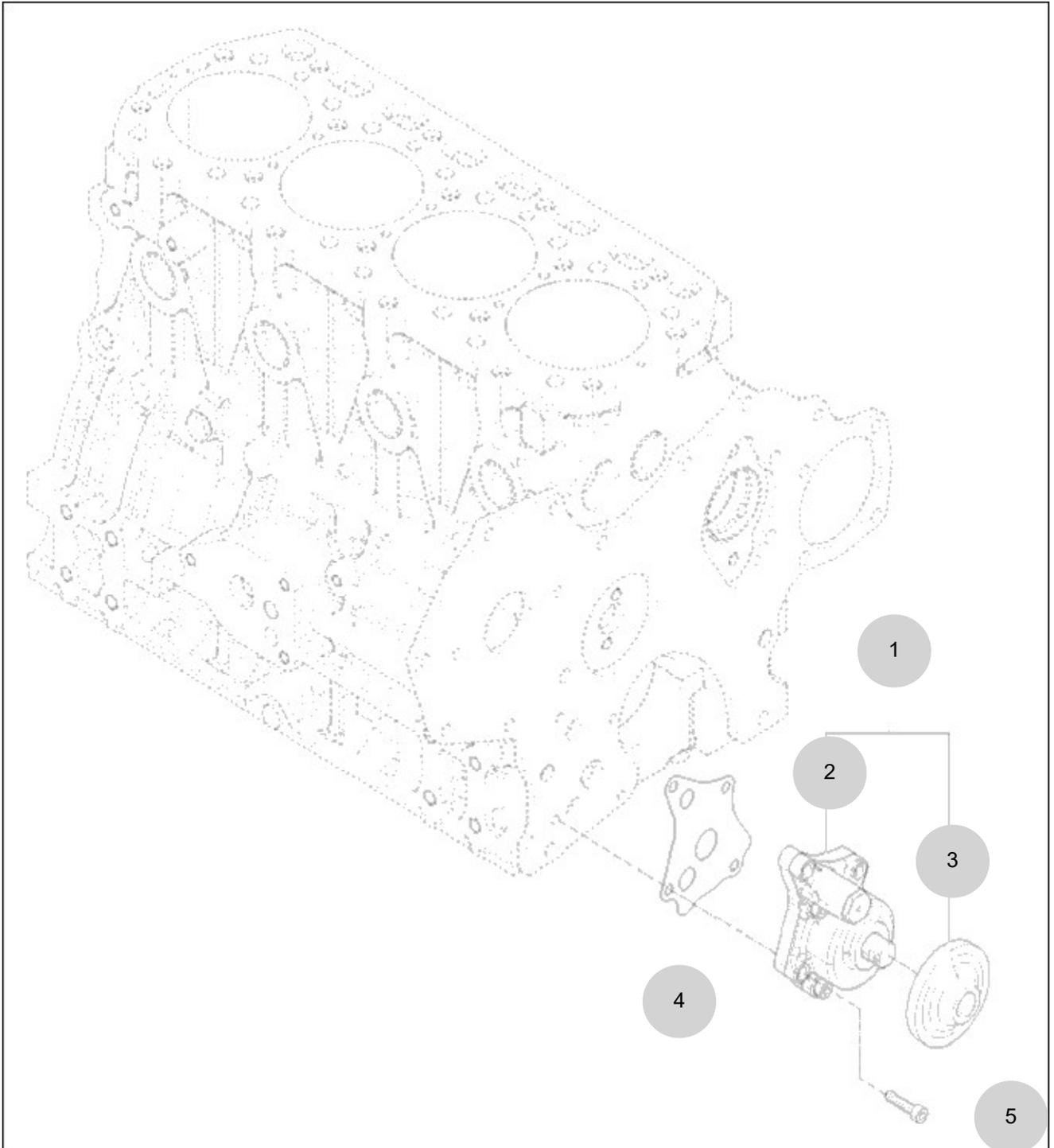

NOTE



FIG 112

T574ST-B

HYD. PUMP DRIVE

년/월  
Year/Month

2022-12

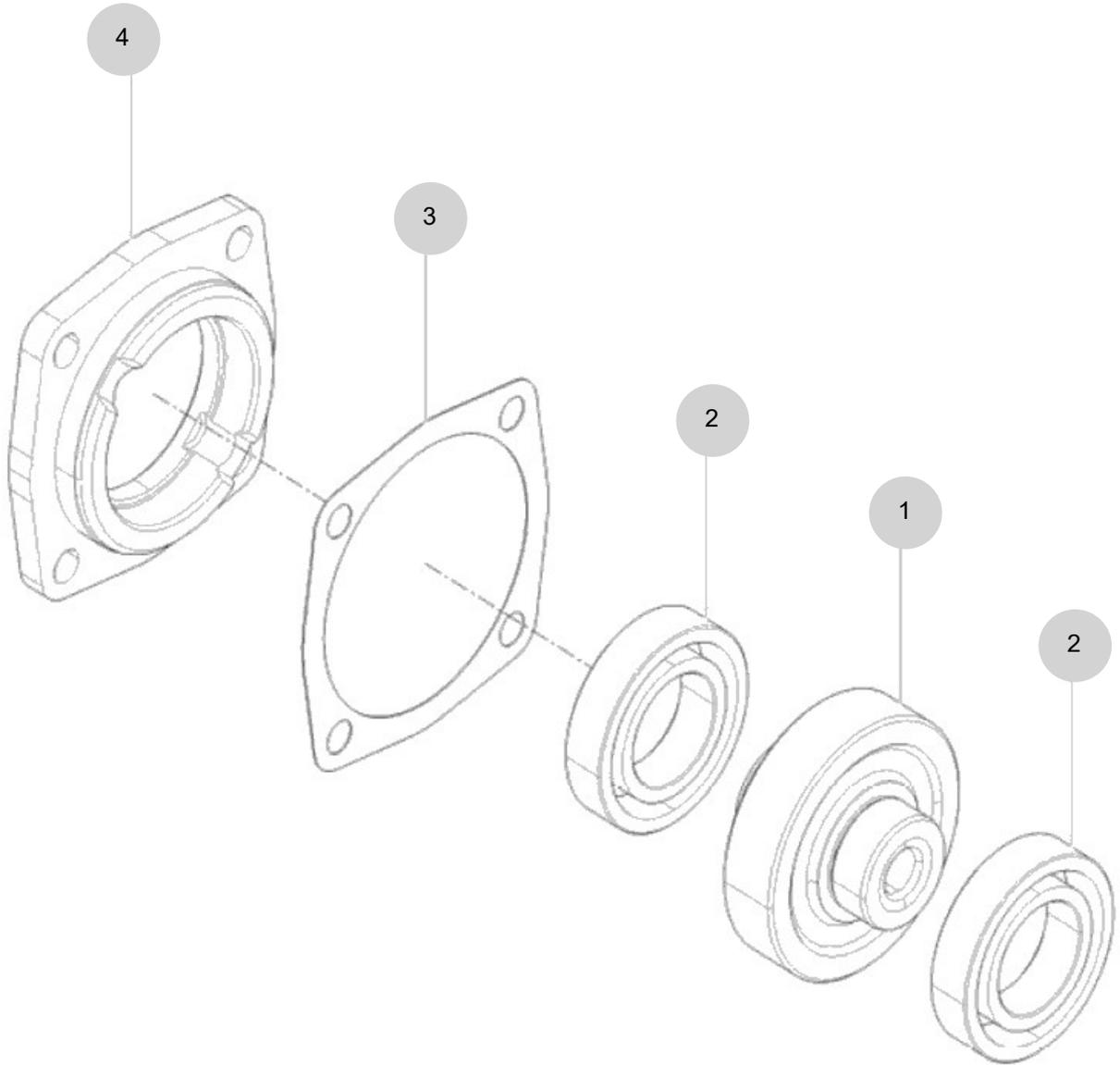

NOTE



FIG 113

T574ST-B

2ND BALANCE

년/월  
Year/Month

2022-12

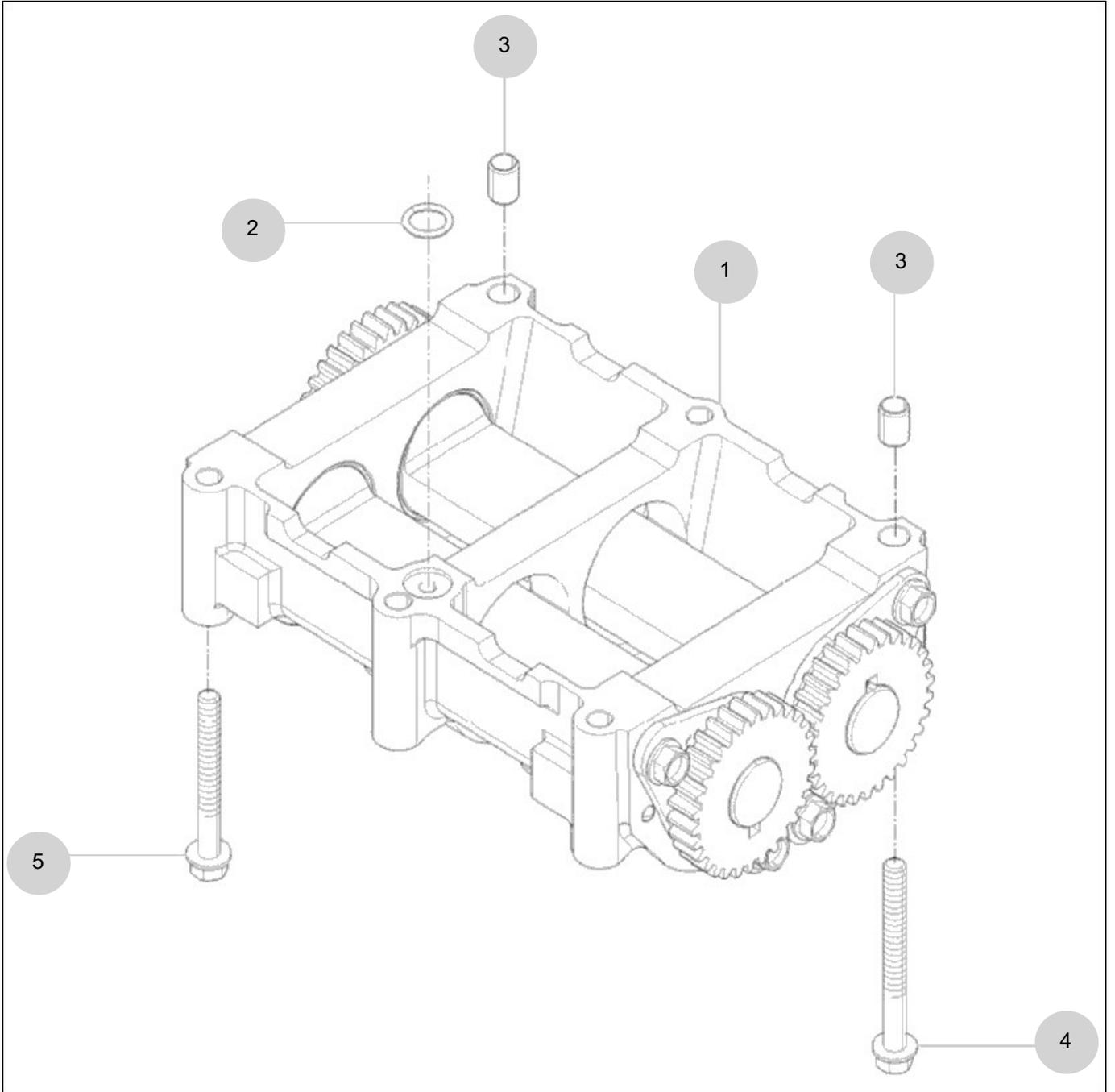

NOTE





FIG 114

T574ST-B

OIL PAN

년/월  
Year/Month

2022-12

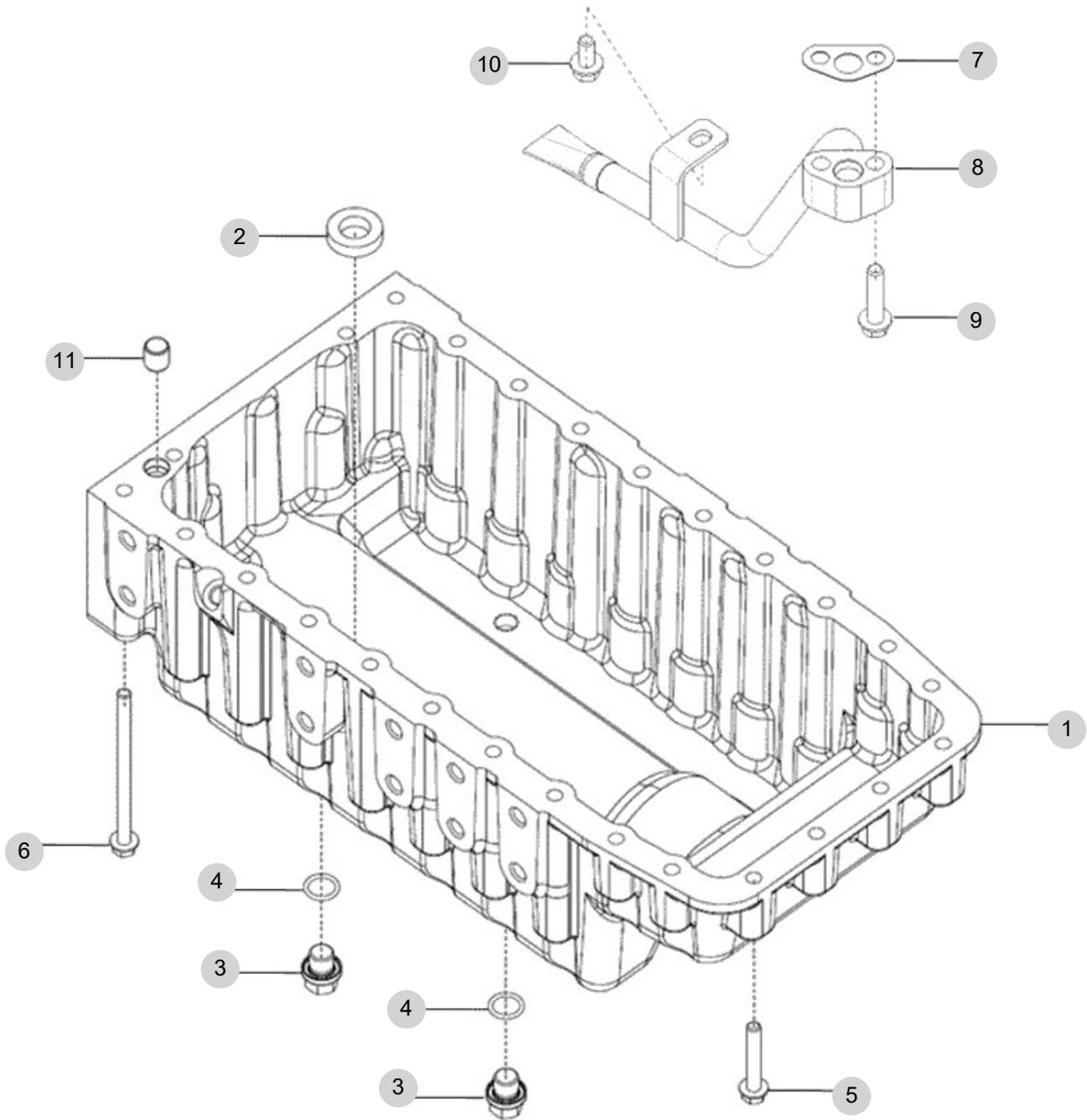

NOTE



FIG 115A

INTAKE MANIFOLD(T574)

년/월  
Year/Month

T574ST-B

2022-12

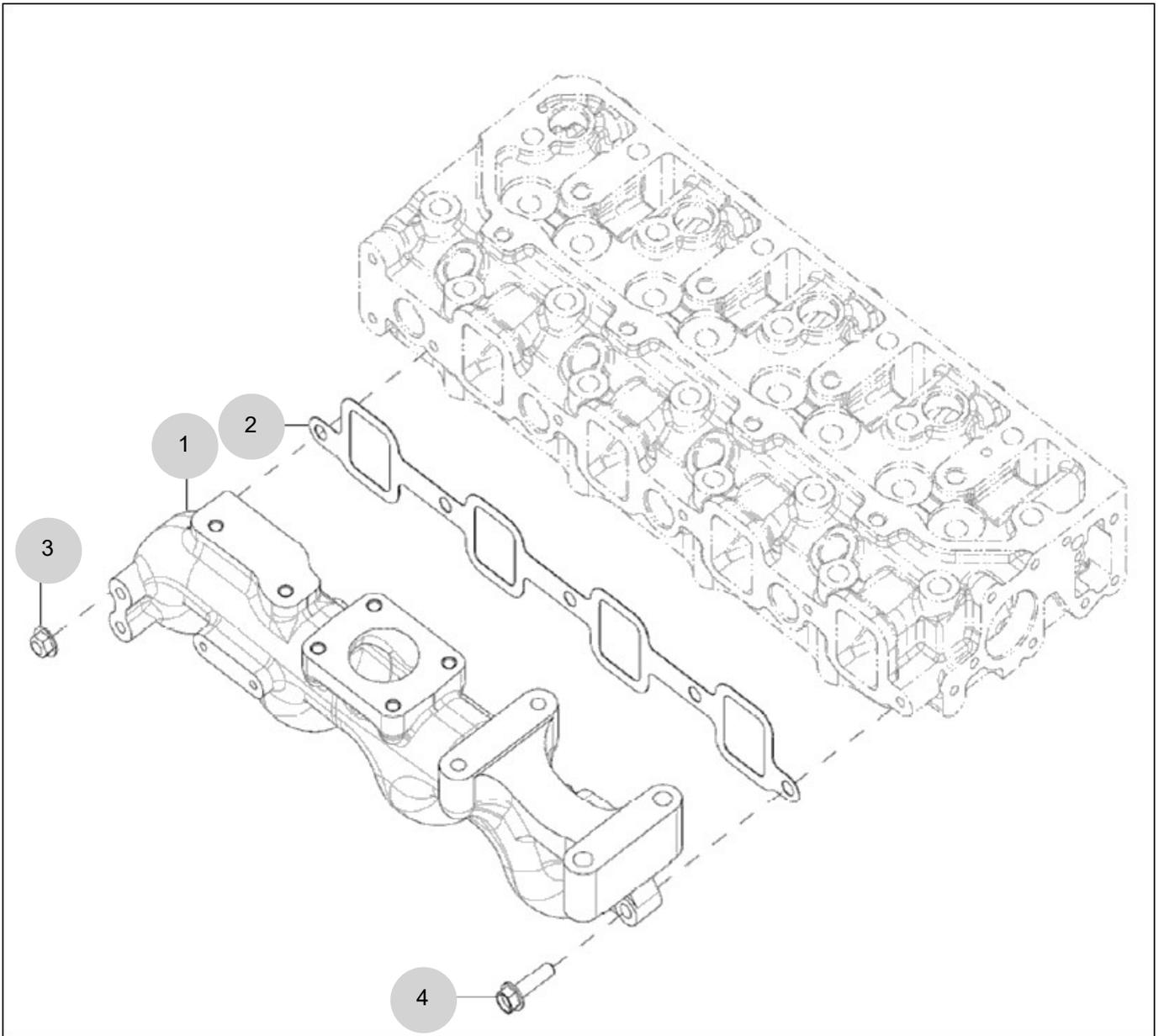

NOTE



FIG 116A

EXHAUST MANIFOLD(T574)

년/월  
Year/Month

T574ST-B

2022-12

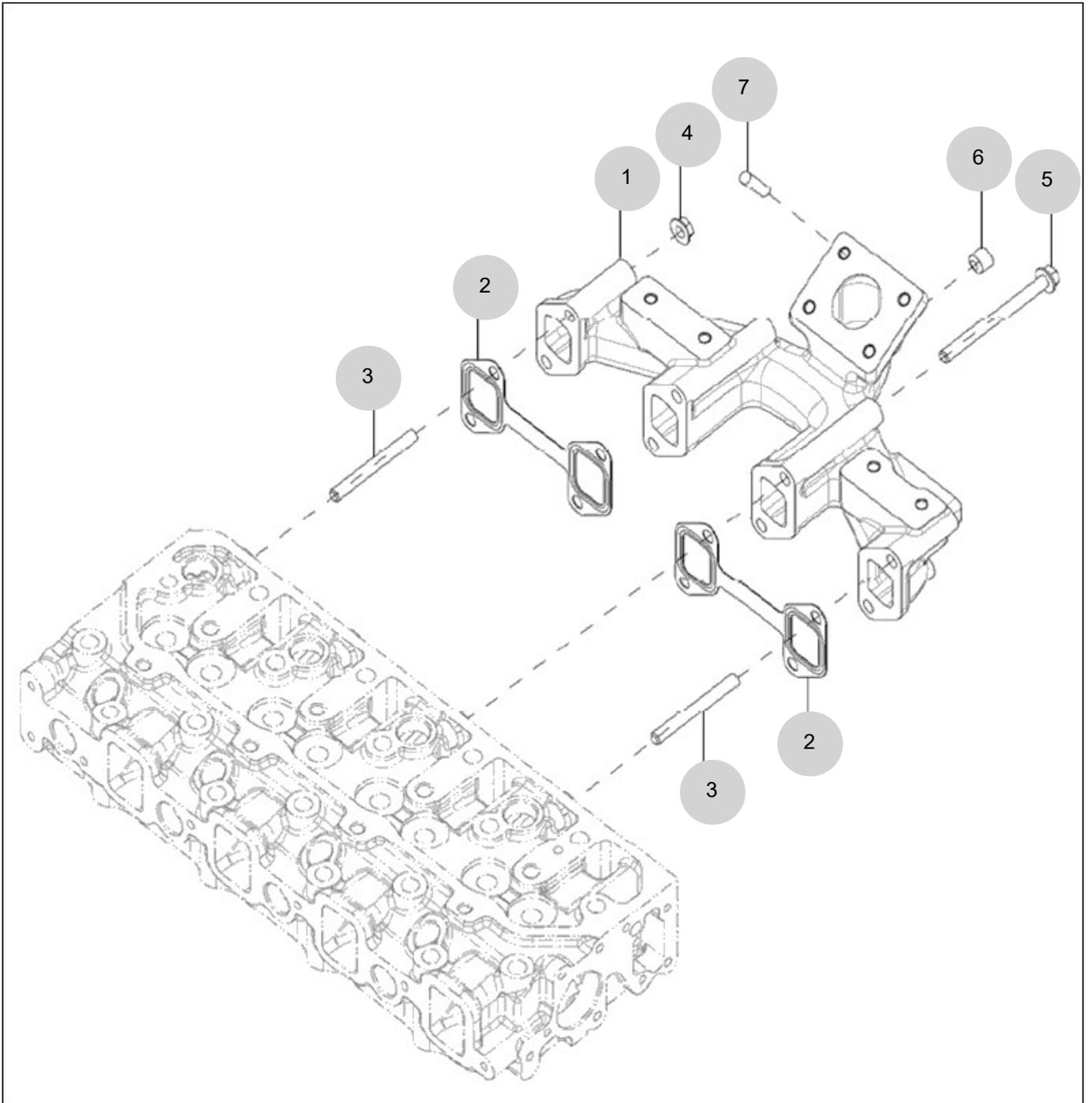

NOTE



FIG 117A

TURBOCHARGER ASS'Y(T574)

년/월  
Year/Month

2022-12

T574ST-B

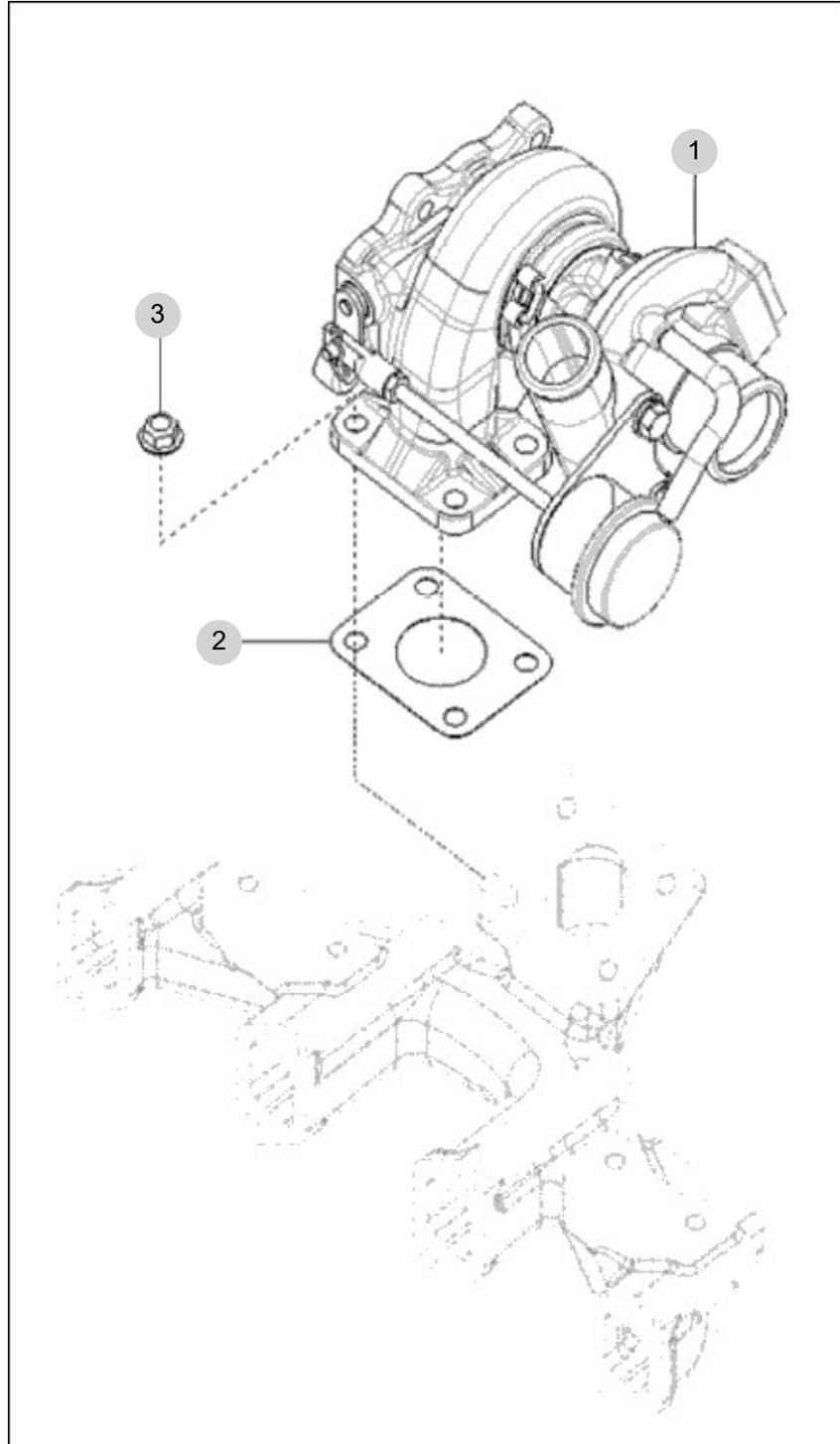

NOTE





FIG 118A

TURBOCHARGER PLUMBING OPTION(T574)

년/월  
Year/Month

T574ST-B

2022-12

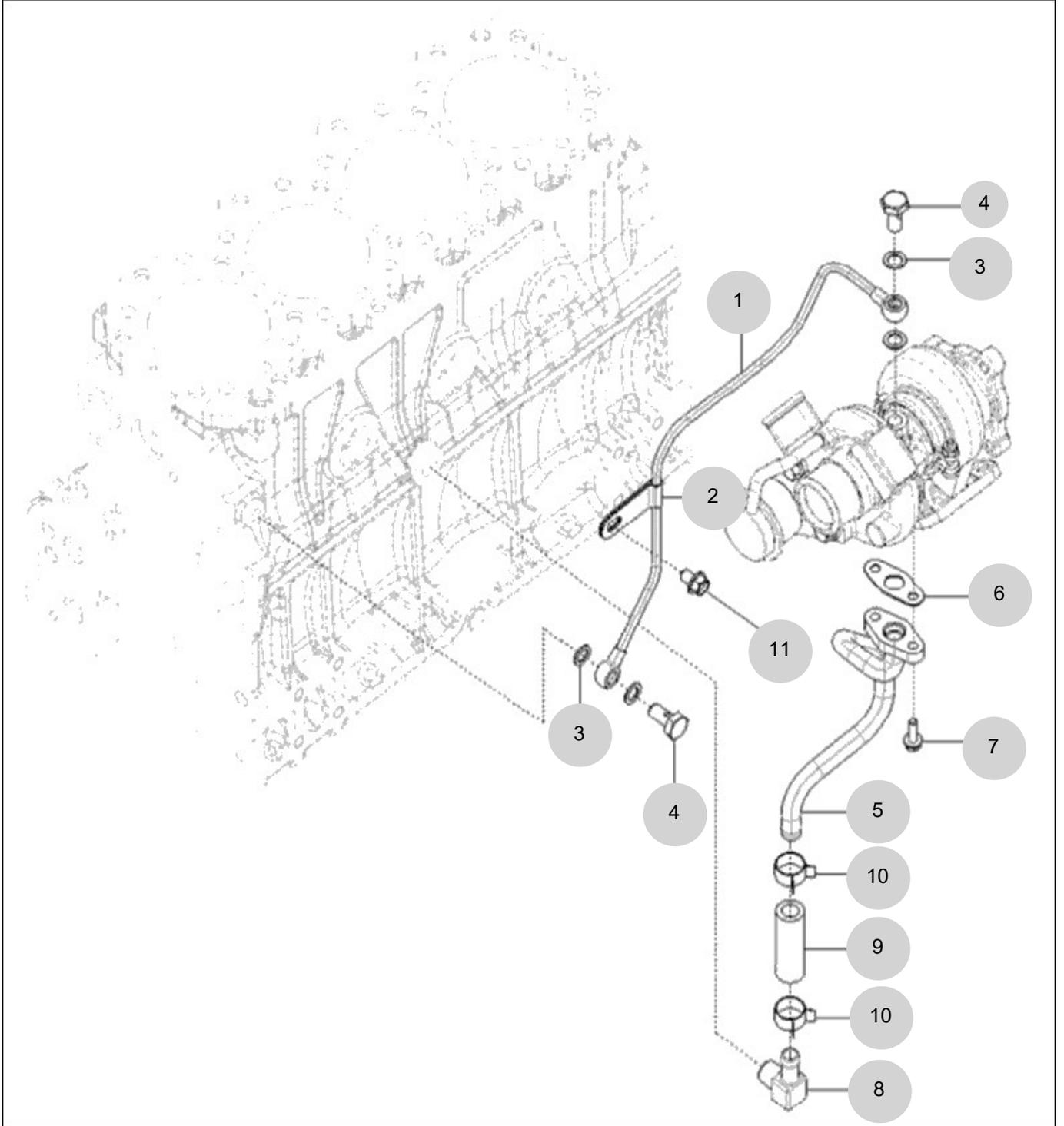

NOTE



FIG 119A

BREATHER(T574)

년/월  
Year/Month

T574ST-B

2022-12

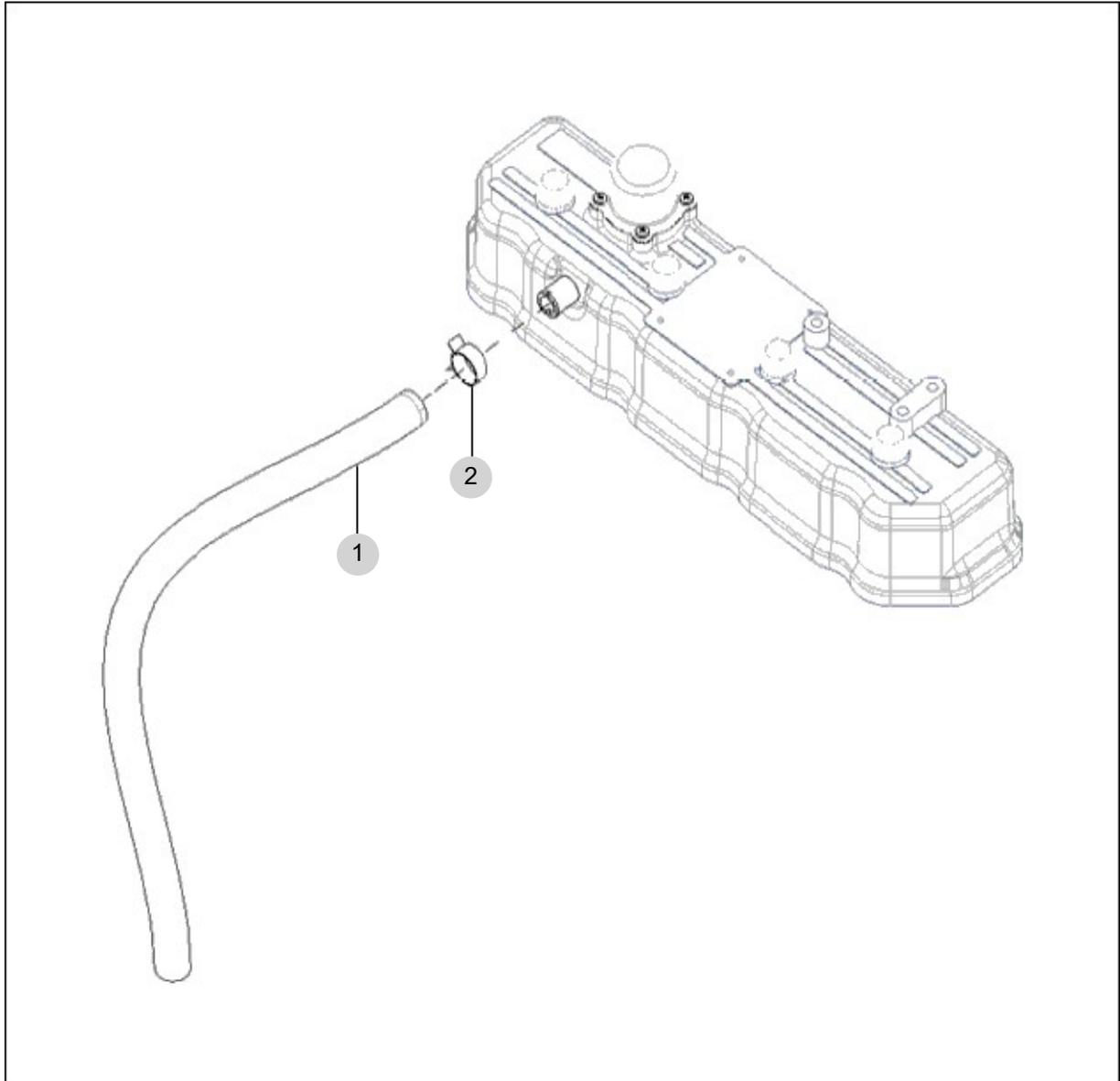

NOTE



FIG 120

FUEL INJECTION PUMP

년/월  
Year/Month

2022-12

T574ST-B

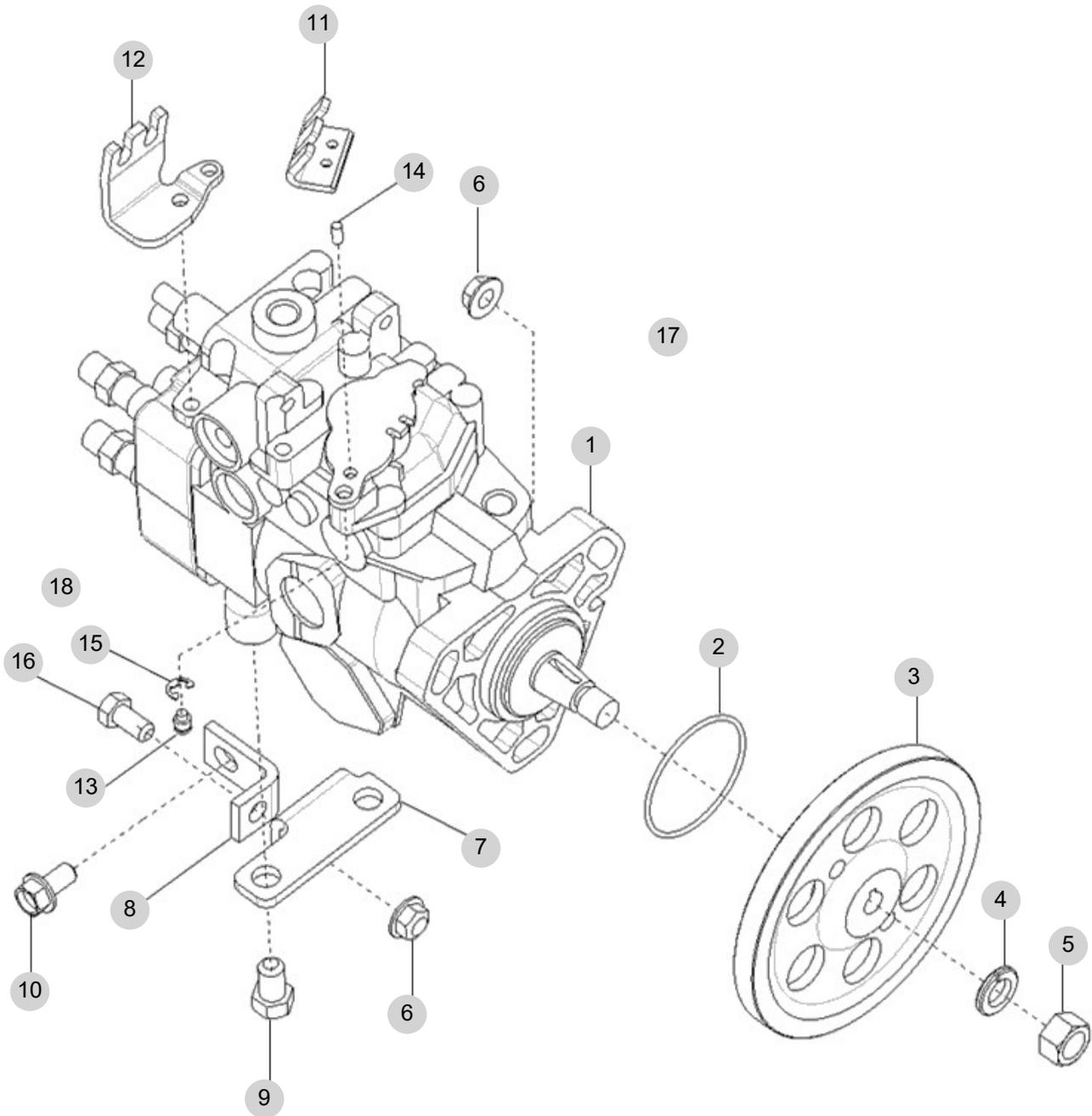

NOTE



FIG 121

T574ST-B

FUEL INJECTION VALVE

년/월  
Year/Month

2022-12

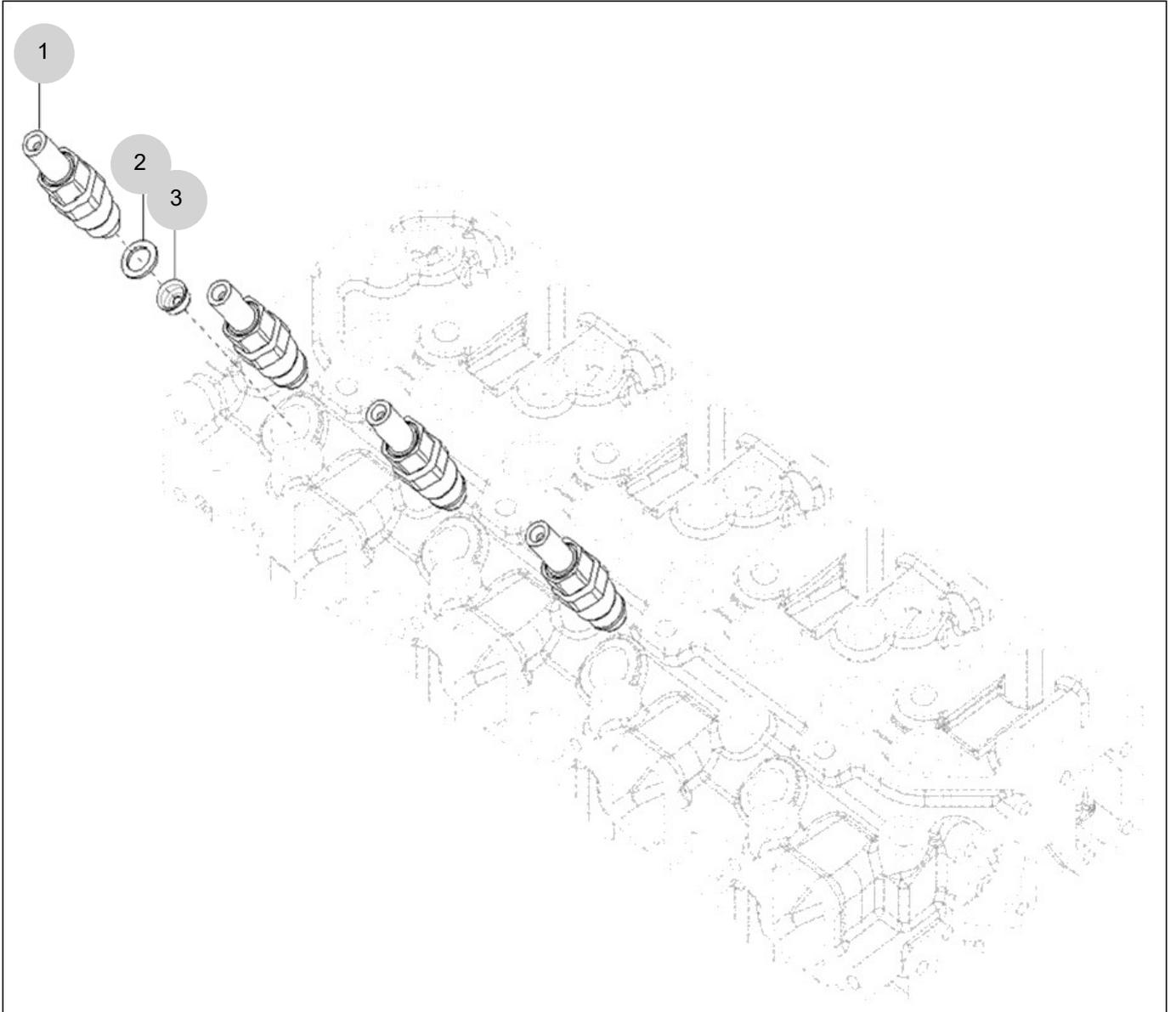

NOTE





FIG 122

FUEL PIPE ASS'Y

년/월  
Year/Month

T574ST-B

2022-12

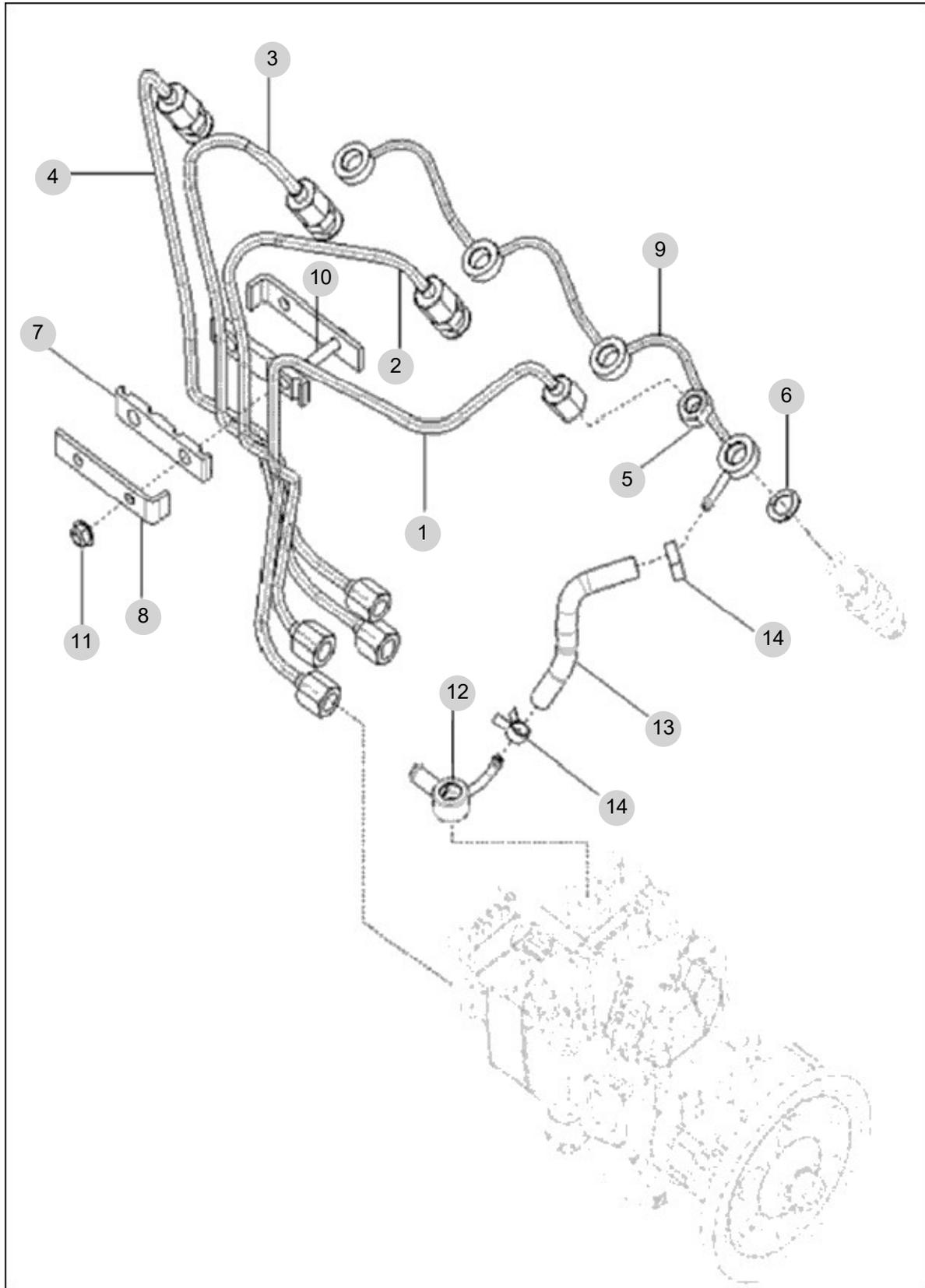

NOTE



FIG 123

T574ST-B

OIL FILTER

년/월  
Year/Month

2022-12

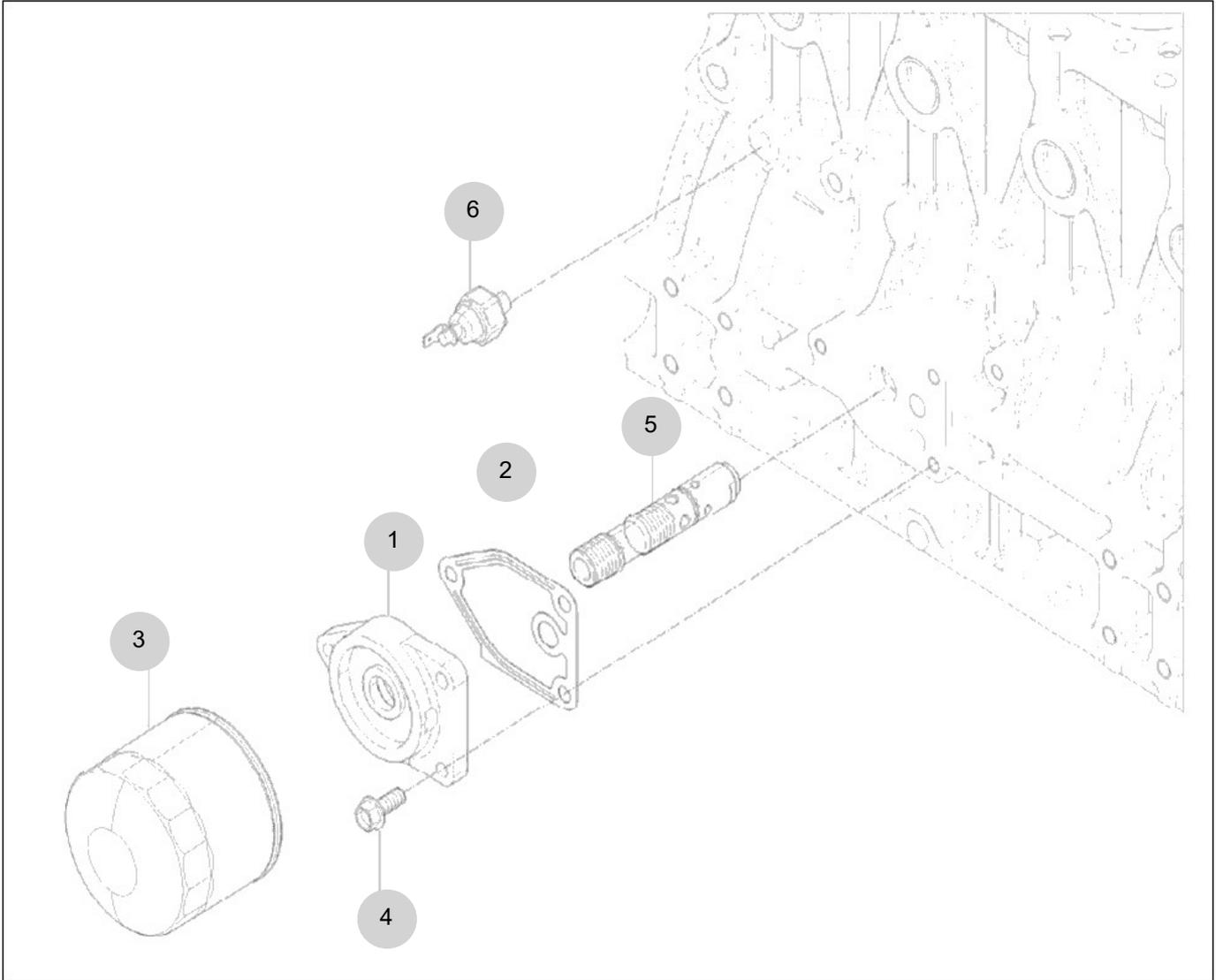

NOTE



FIG 124

T574ST-B

OIL COOLER

년/월  
Year/Month

2022-12

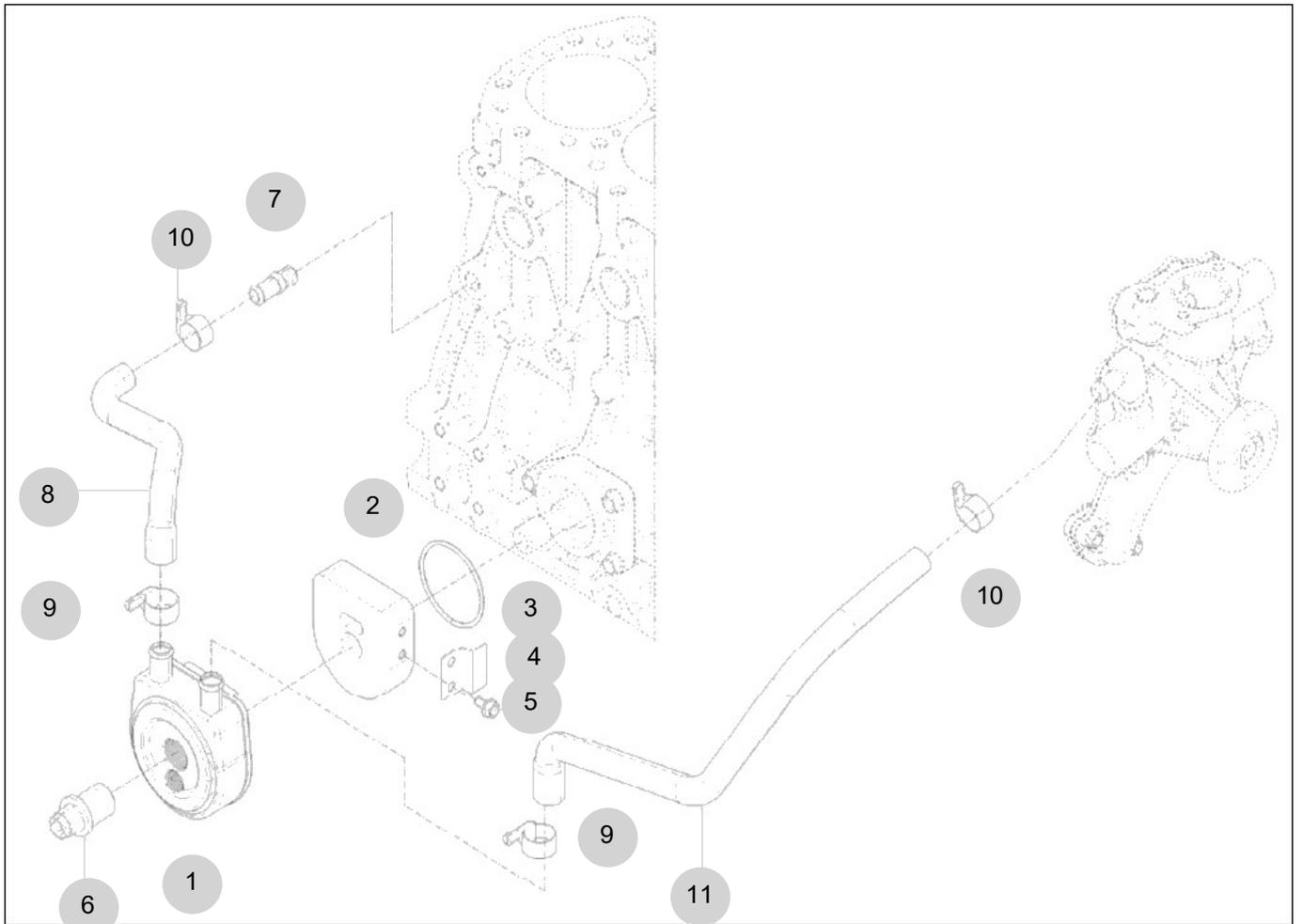

NOTE



FIG 125

OIL GAUGUE

년/월  
Year/Month

T574ST-B

2022-12

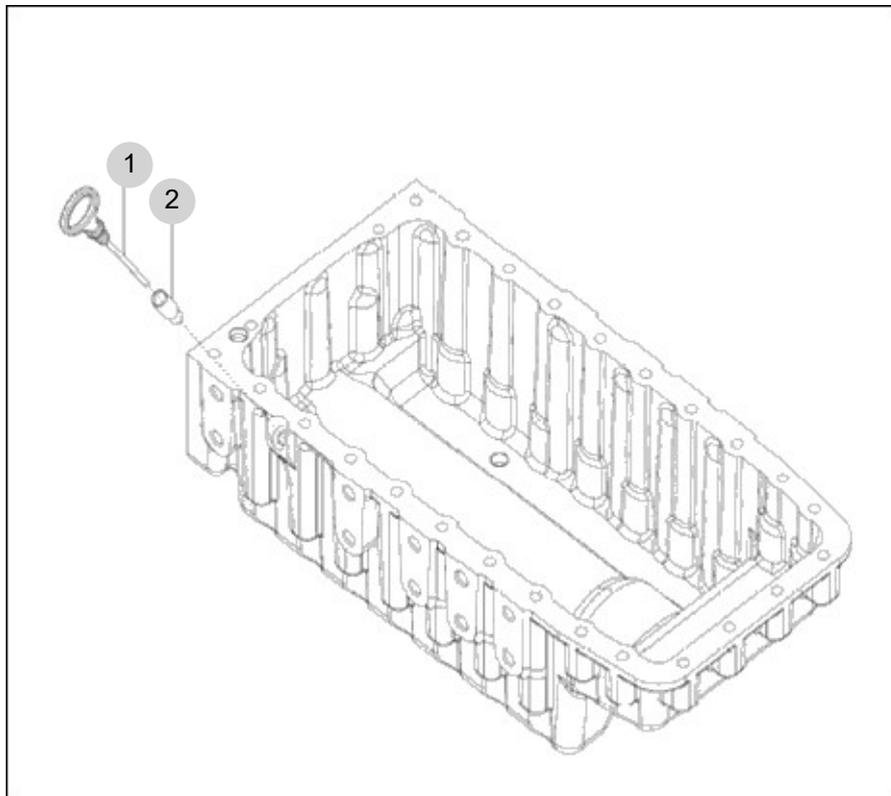

NOTE





FIG 126

T574ST-B

OIL FILLER CAP

년/월  
Year/Month

2022-12

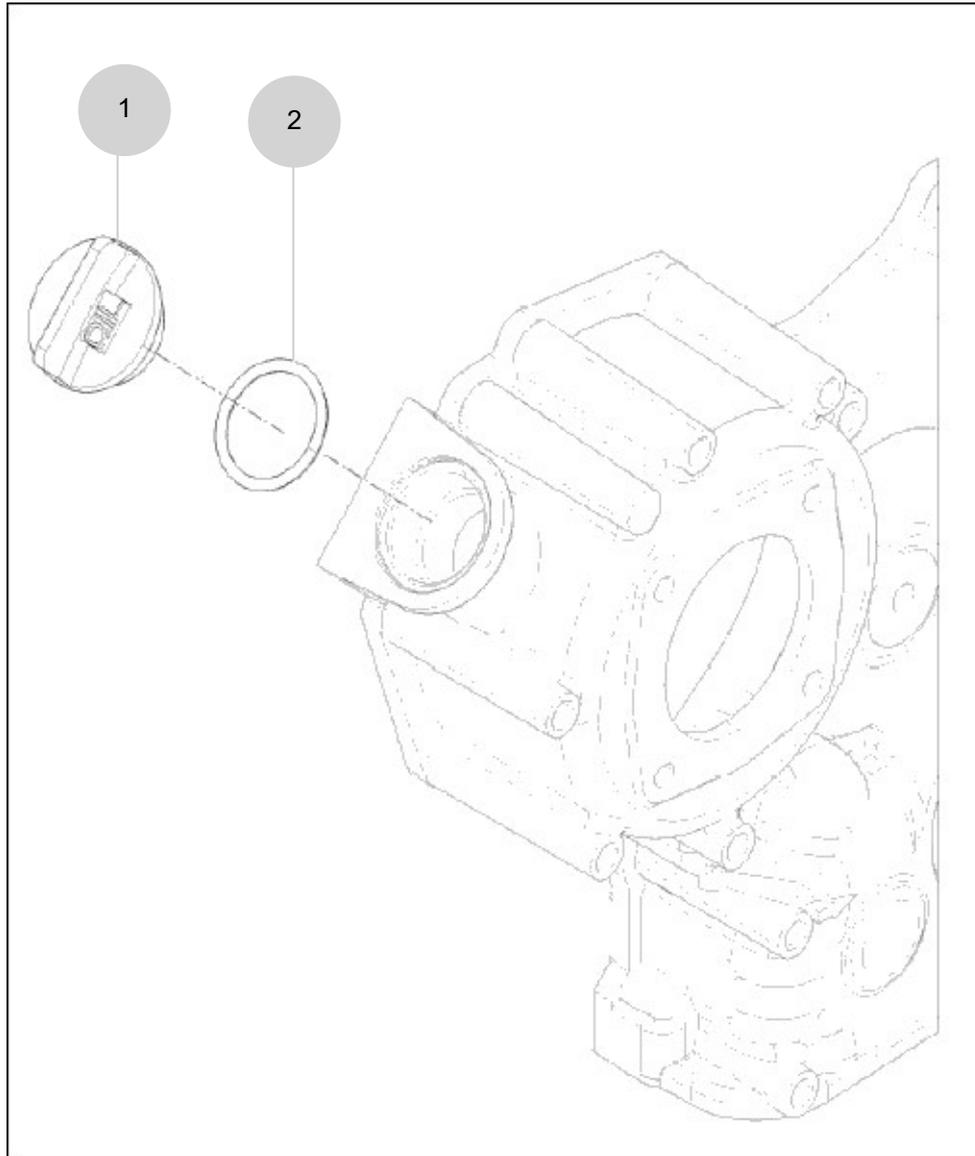

NOTE



FIG 127

COOLING WATER PUMP

년/월  
Year/Month

2022-12

T574ST-B

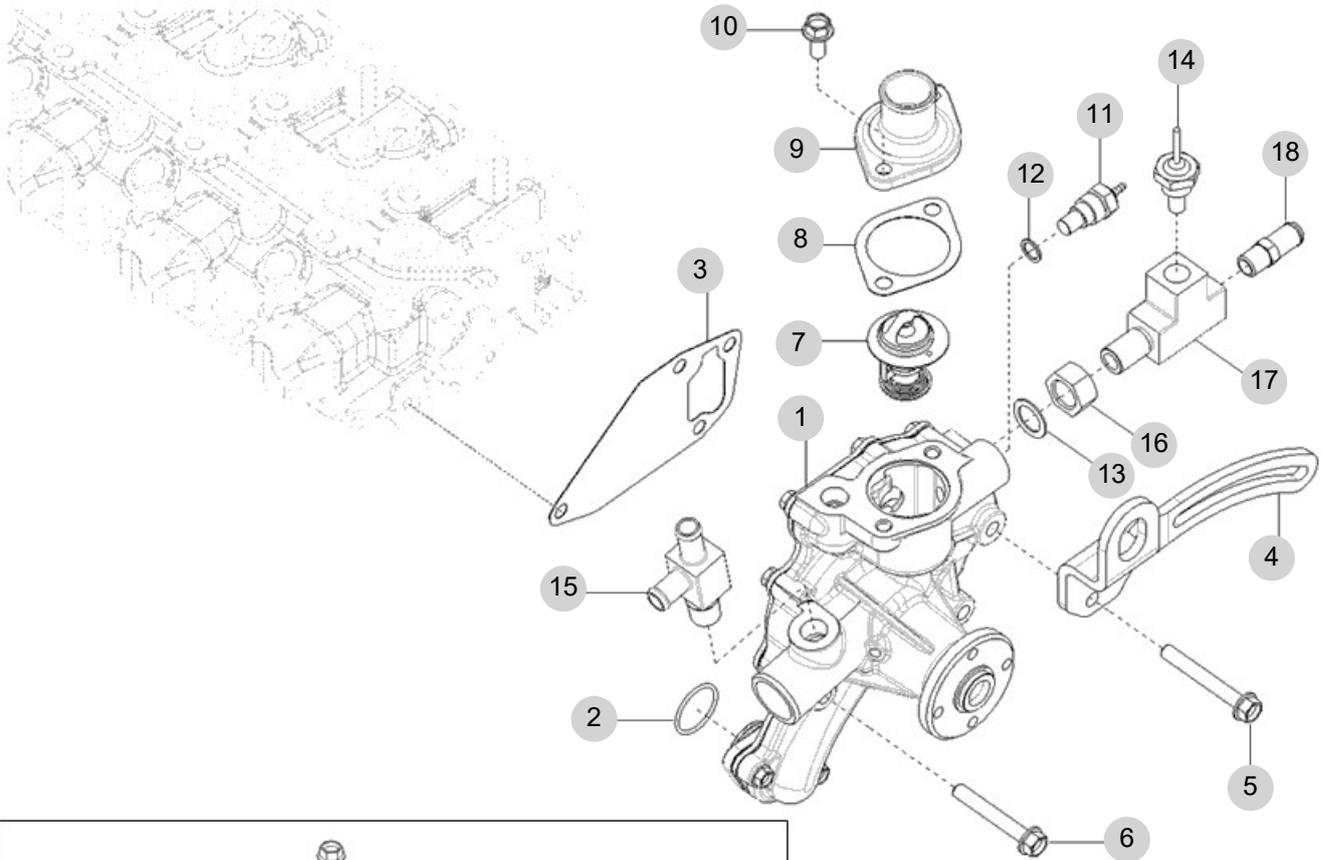

ROPS 타입

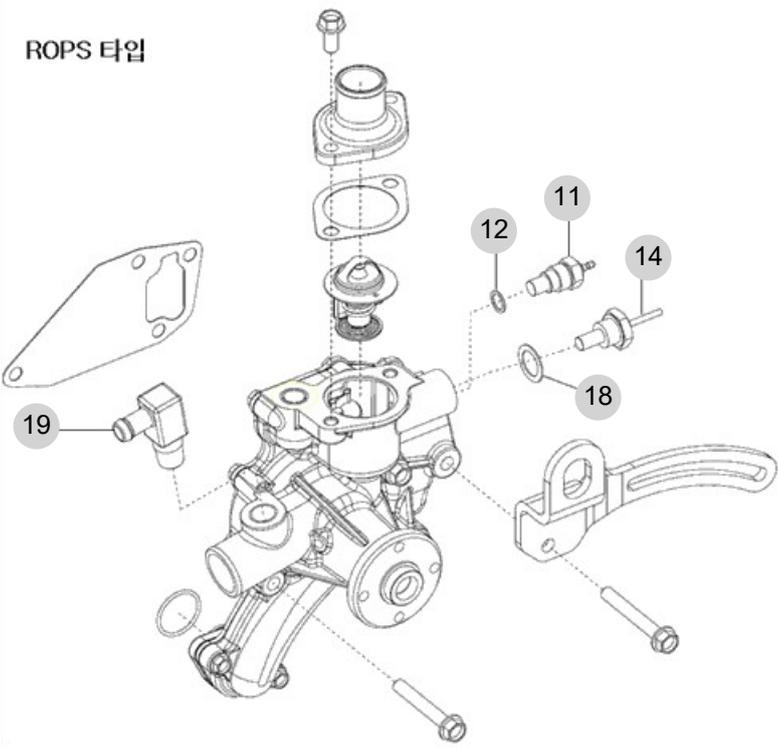

NOTE



FIG 128

T574ST-B

CRANK SHAFT PULLEY

년/월  
Year/Month

2022-12

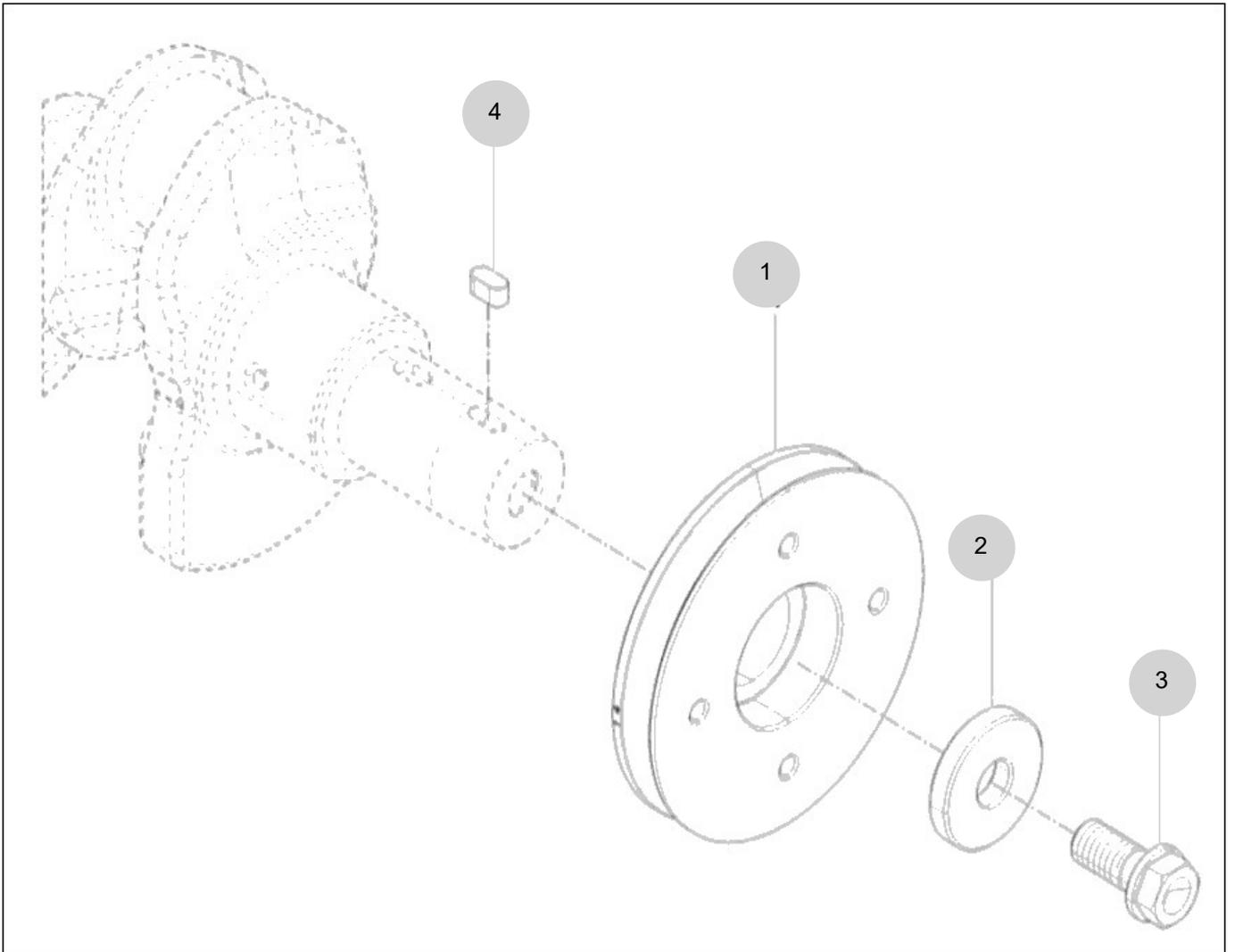

NOTE



FIG 129

V-PULLEY

년/월  
Year/Month

T574ST-B

2022-12

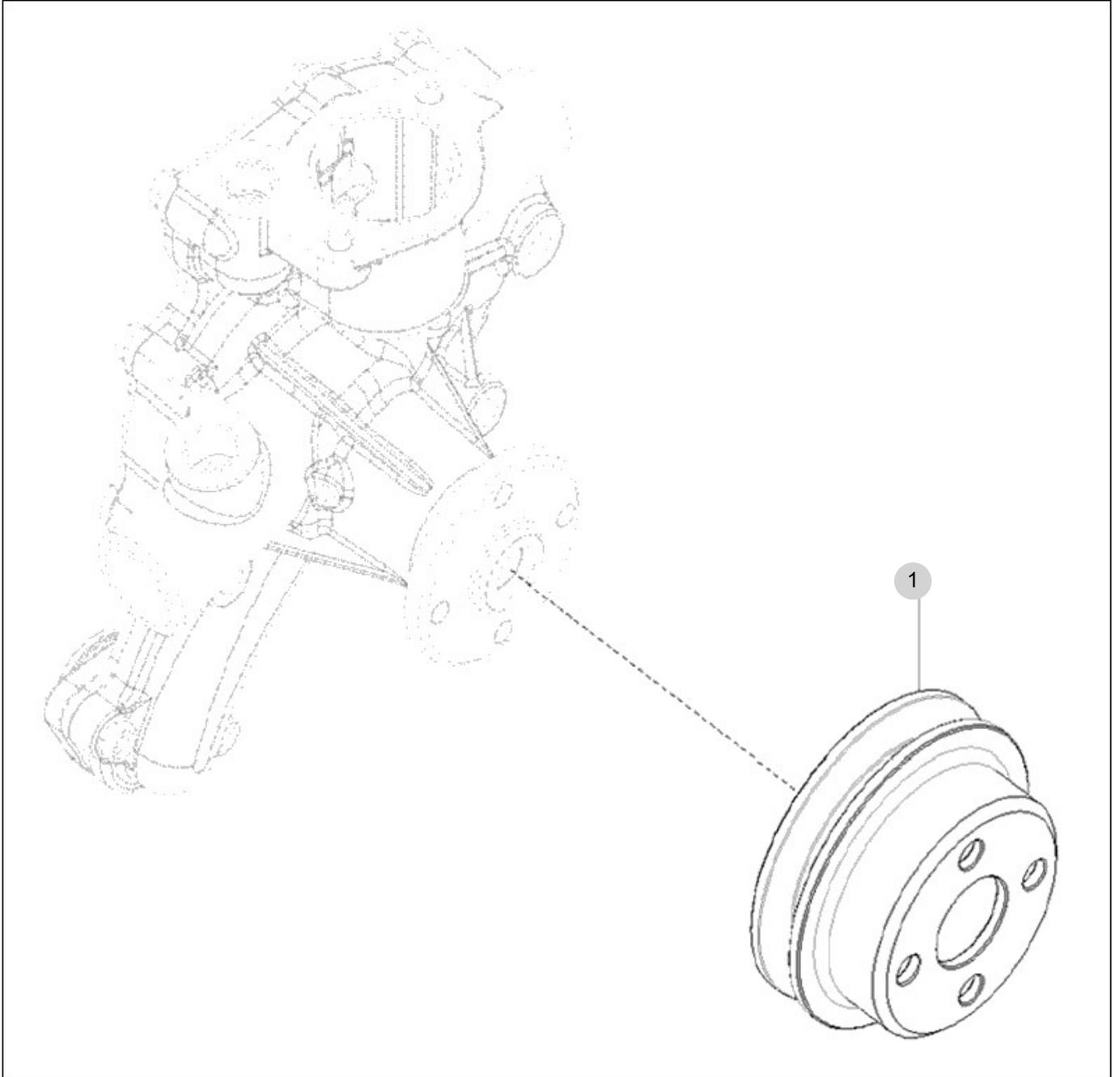

NOTE





FIG 130

COOLING FAN

년/월  
Year/Month

T574ST-B

2022-12

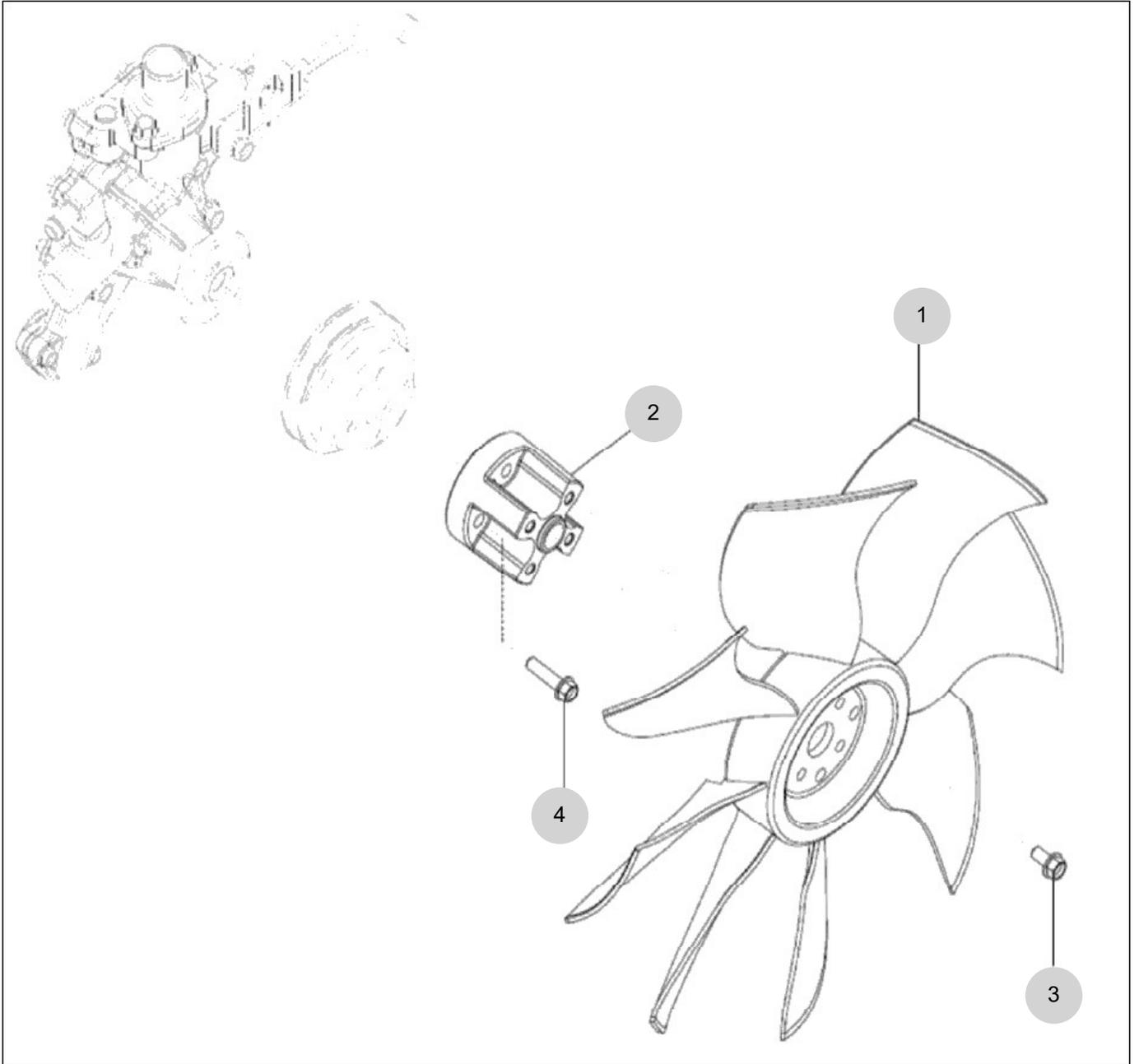

NOTE



FIG 131

T574ST-B

FLYWHEEL HOUSING

년/월  
Year/Month

2022-12

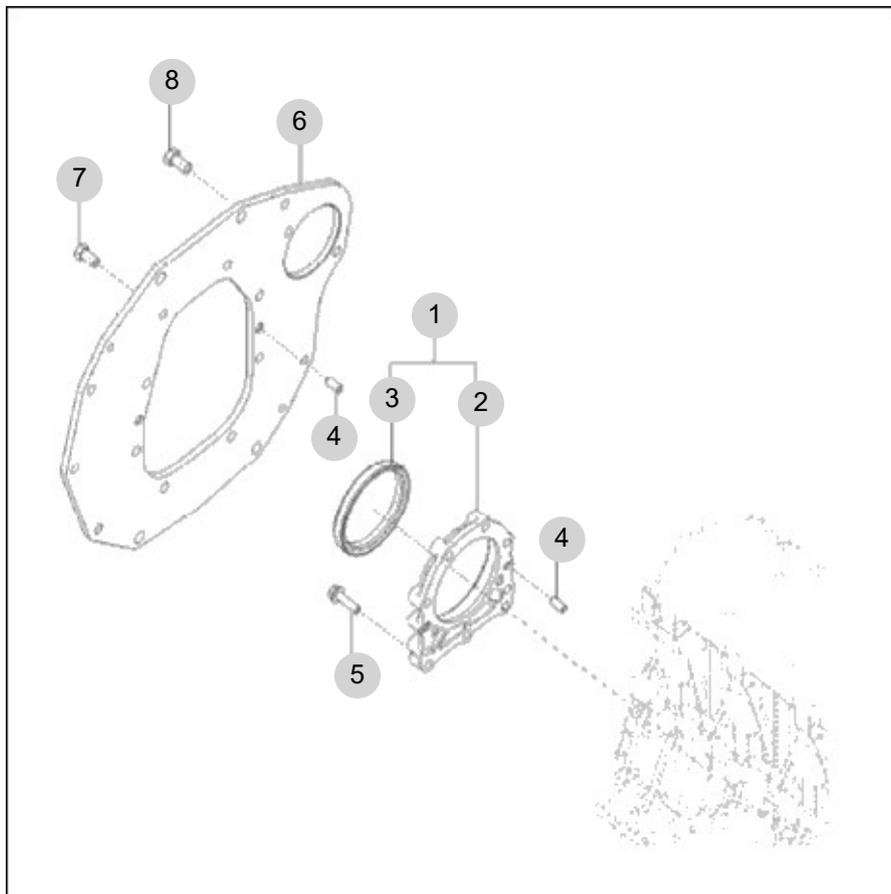

NOTE



FIG 132

T574ST-B

FLYWHEEL

년/월  
Year/Month

2022-12

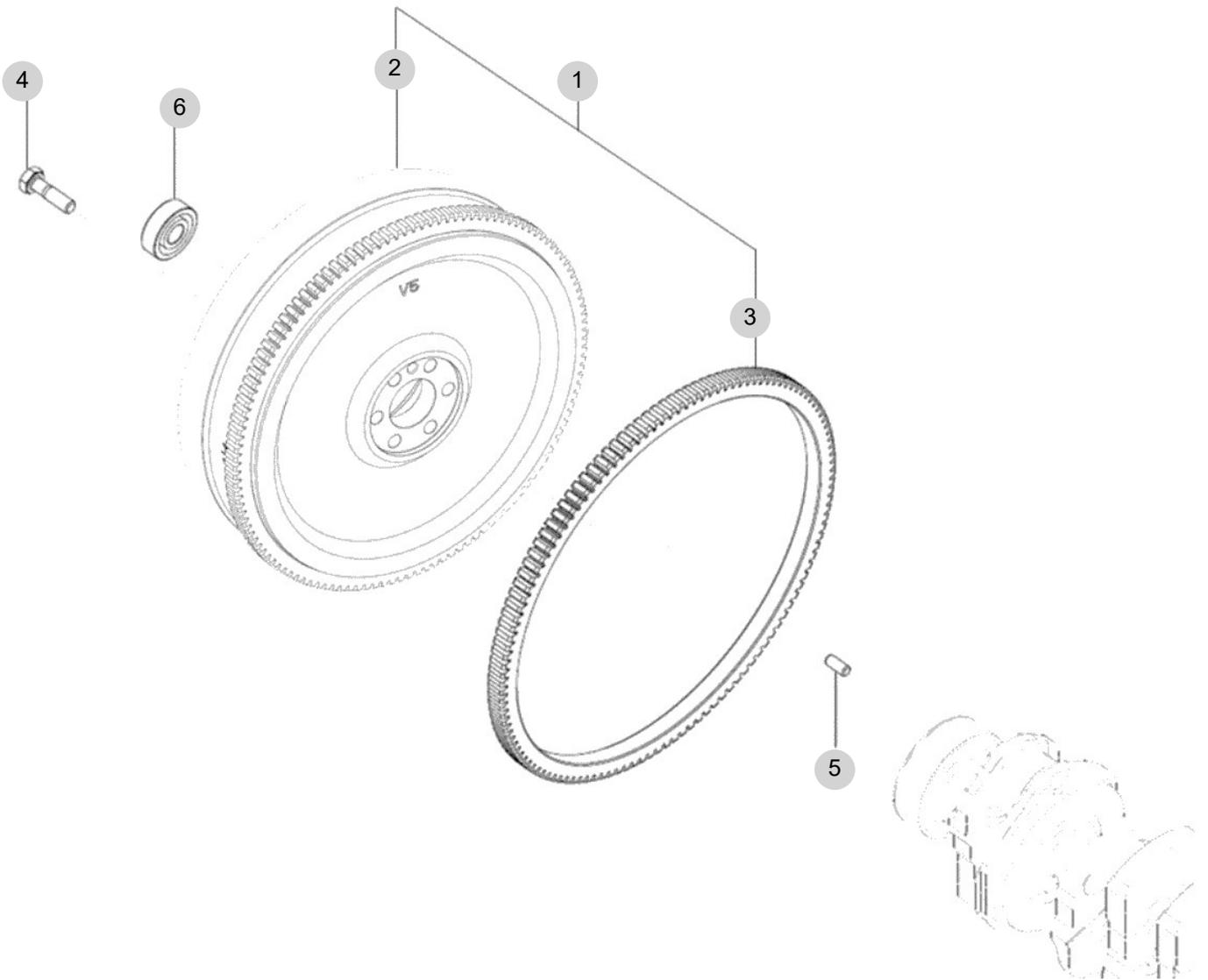

NOTE



FIG 133

T574ST-B

GLOW PLUG ASS'Y OPTION

년/월  
Year/Month

2022-12

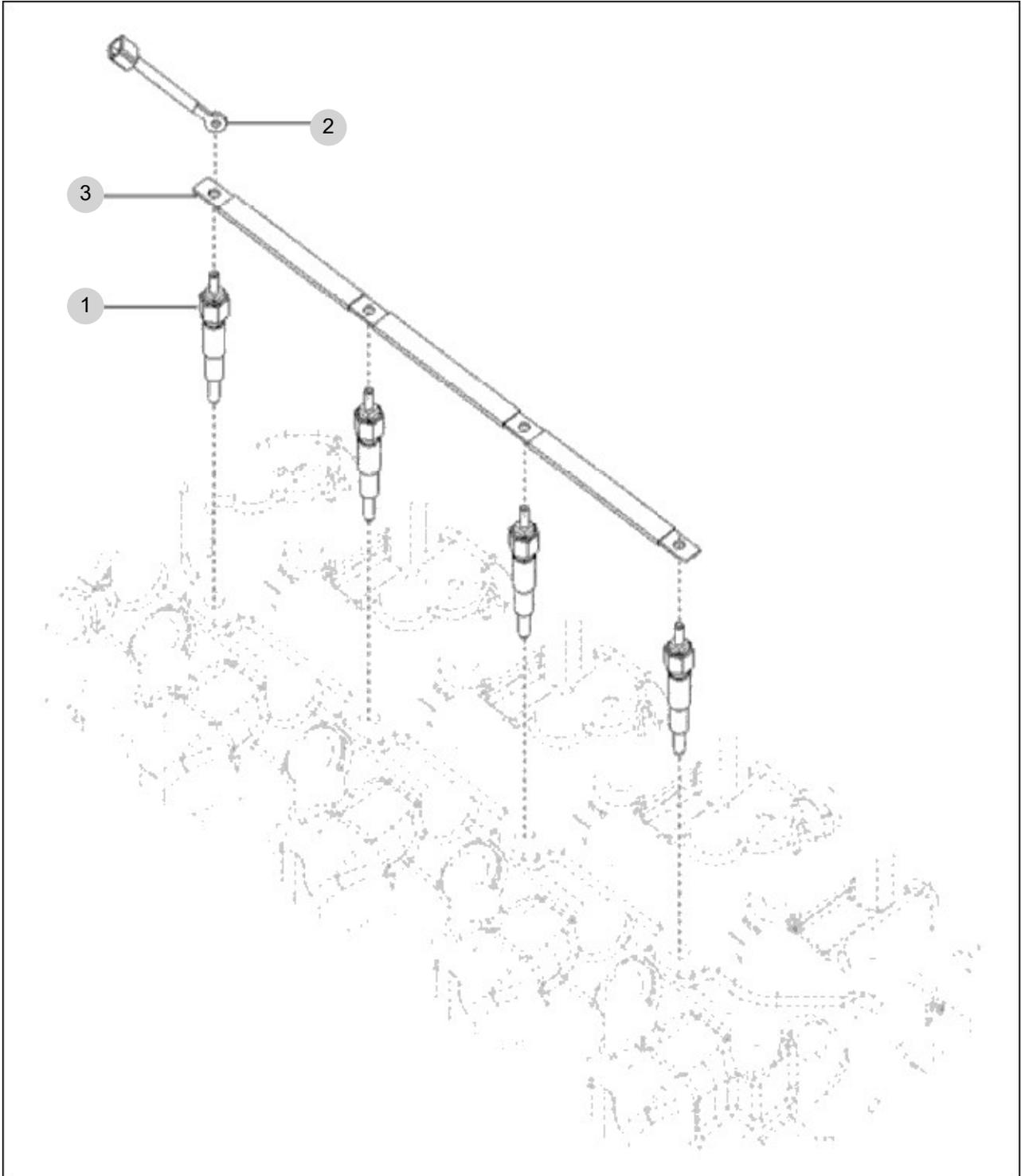

NOTE





FIG 134

STARTING MOTOR

년/월  
Year/Month

T574ST-B

2022-12

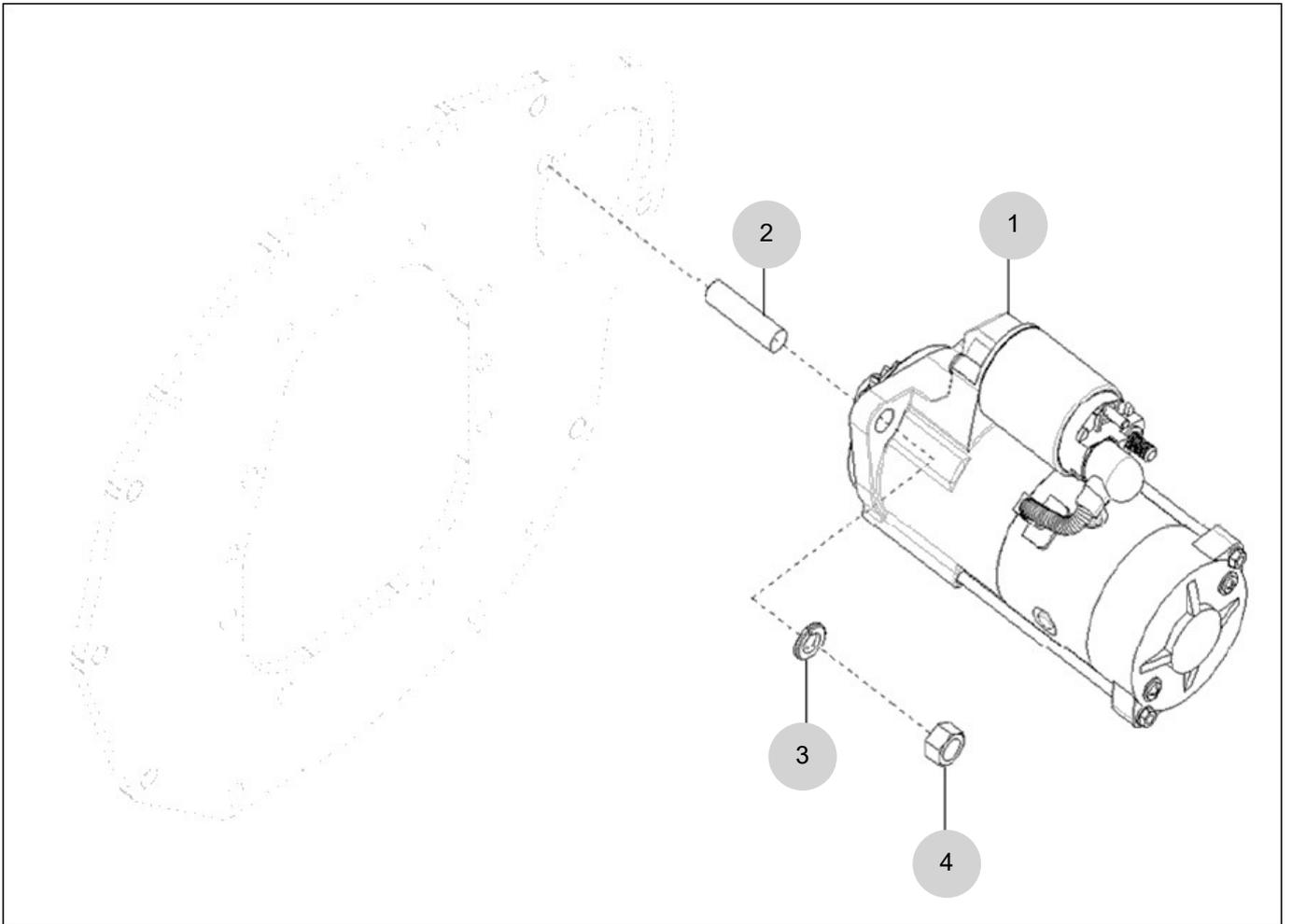

NOTE



FIG 135

T574ST-B

FUEL FILTER BRACKET ASS'Y

년/월  
Year/Month

2022-12

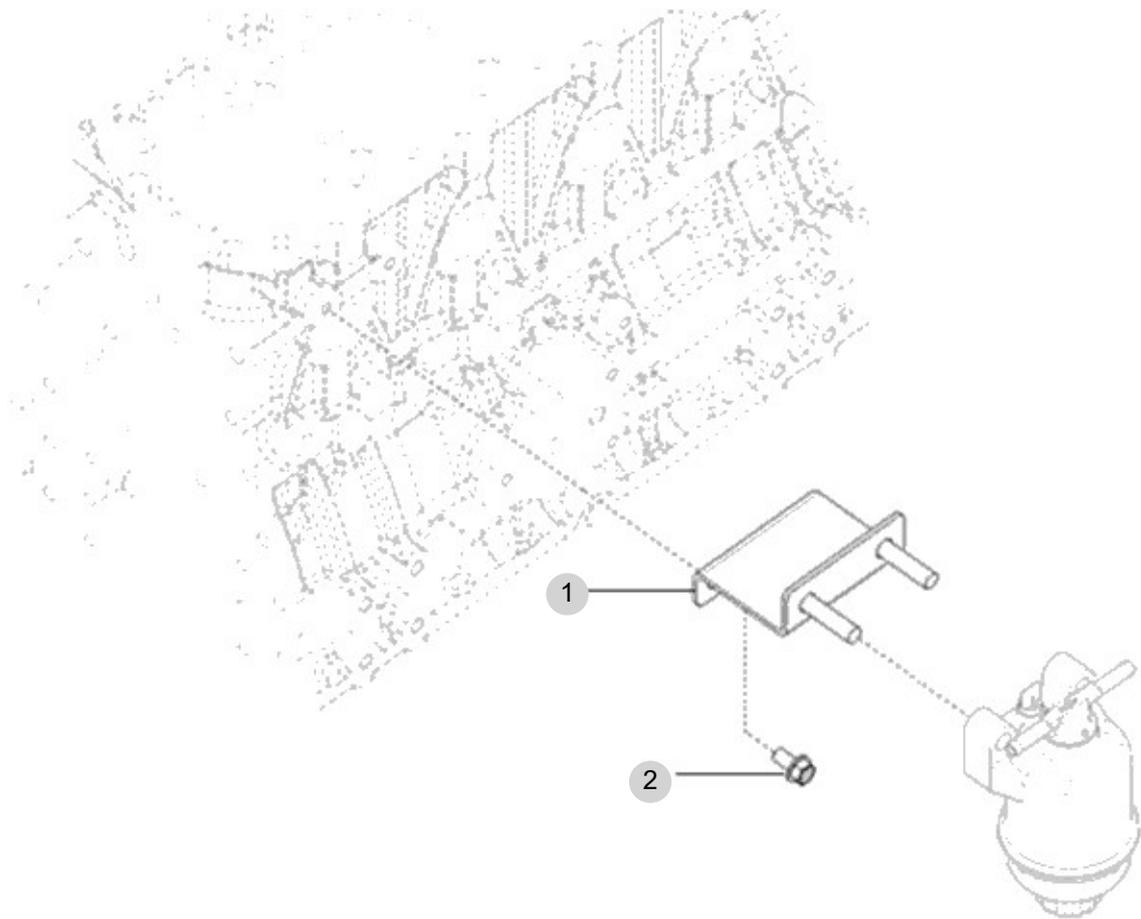

NOTE



FIG 136

T574ST-B

ALTERNATOR

년/월  
Year/Month

2022-12

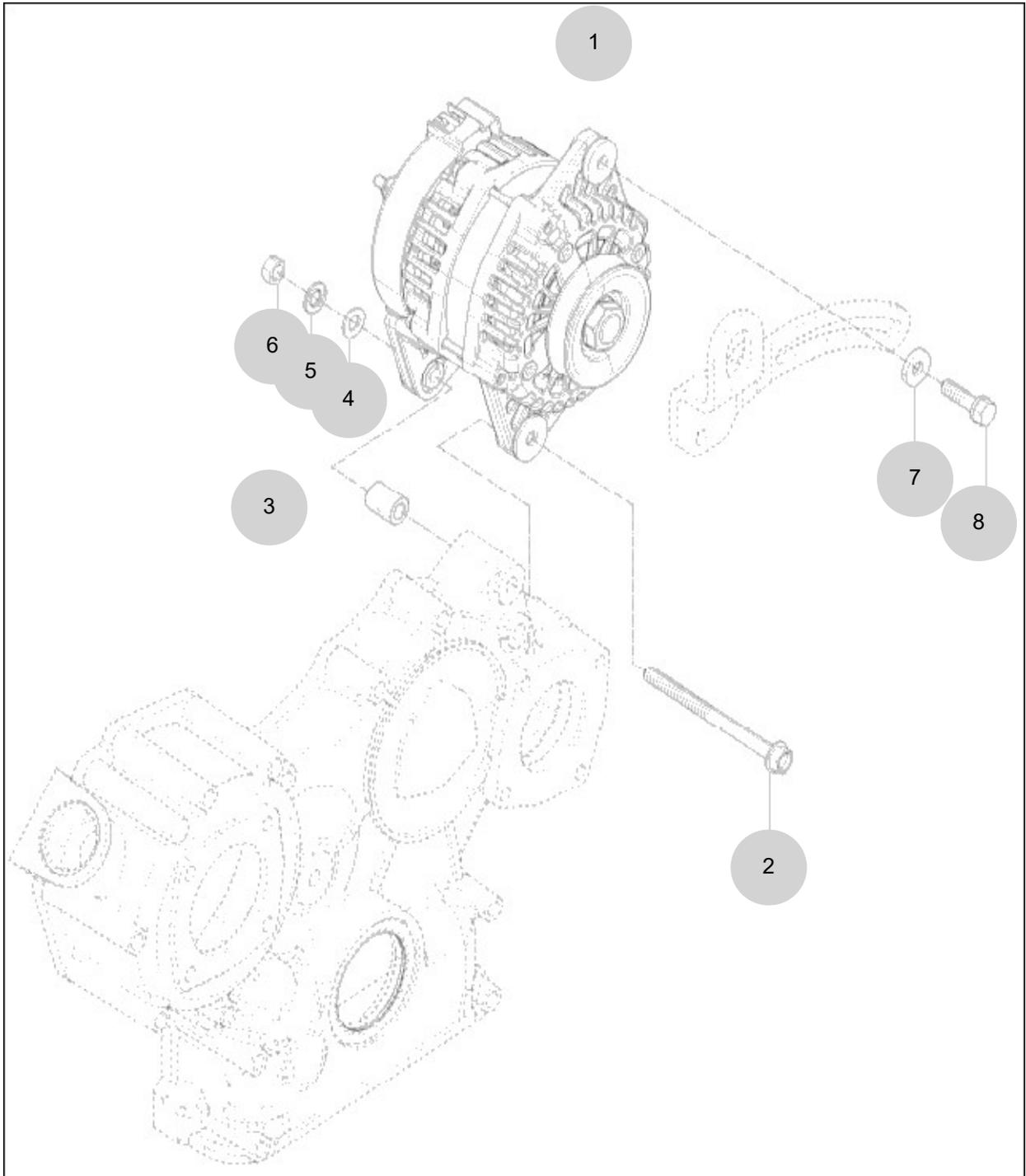

NOTE



FIG 137

T574ST-B

V-BELT

년/월  
Year/Month

2022-12

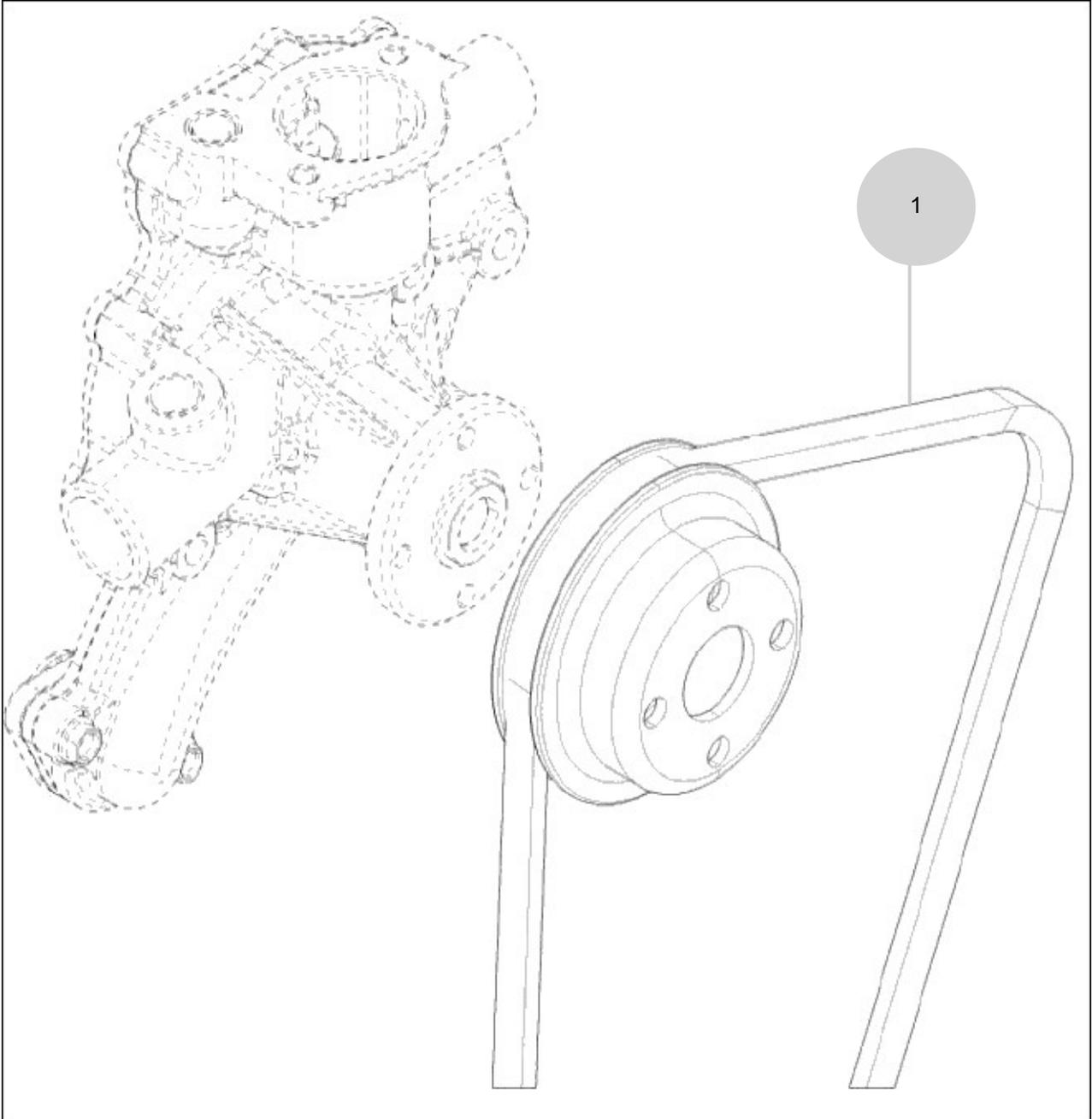

NOTE





FIG 138

T574ST-B

FUEL FILTER

년/월  
Year/Month

2022-12

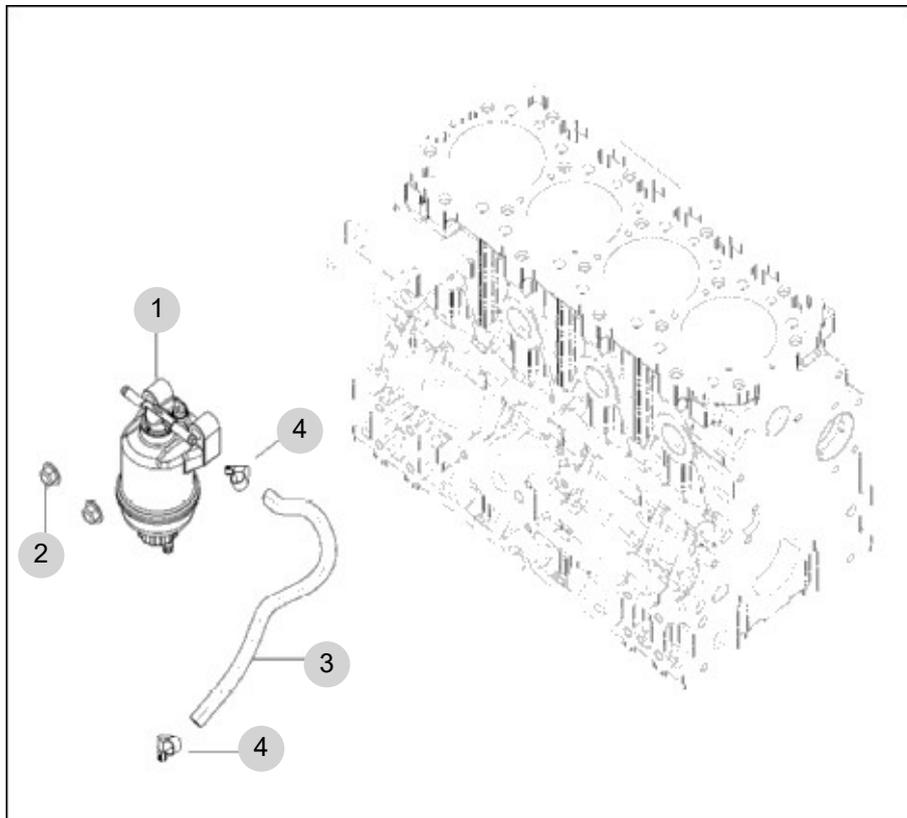

NOTE



FIG 139A

DPF SUPPORT (T574)

년/월  
Year/Month

T574ST-B

2022-12

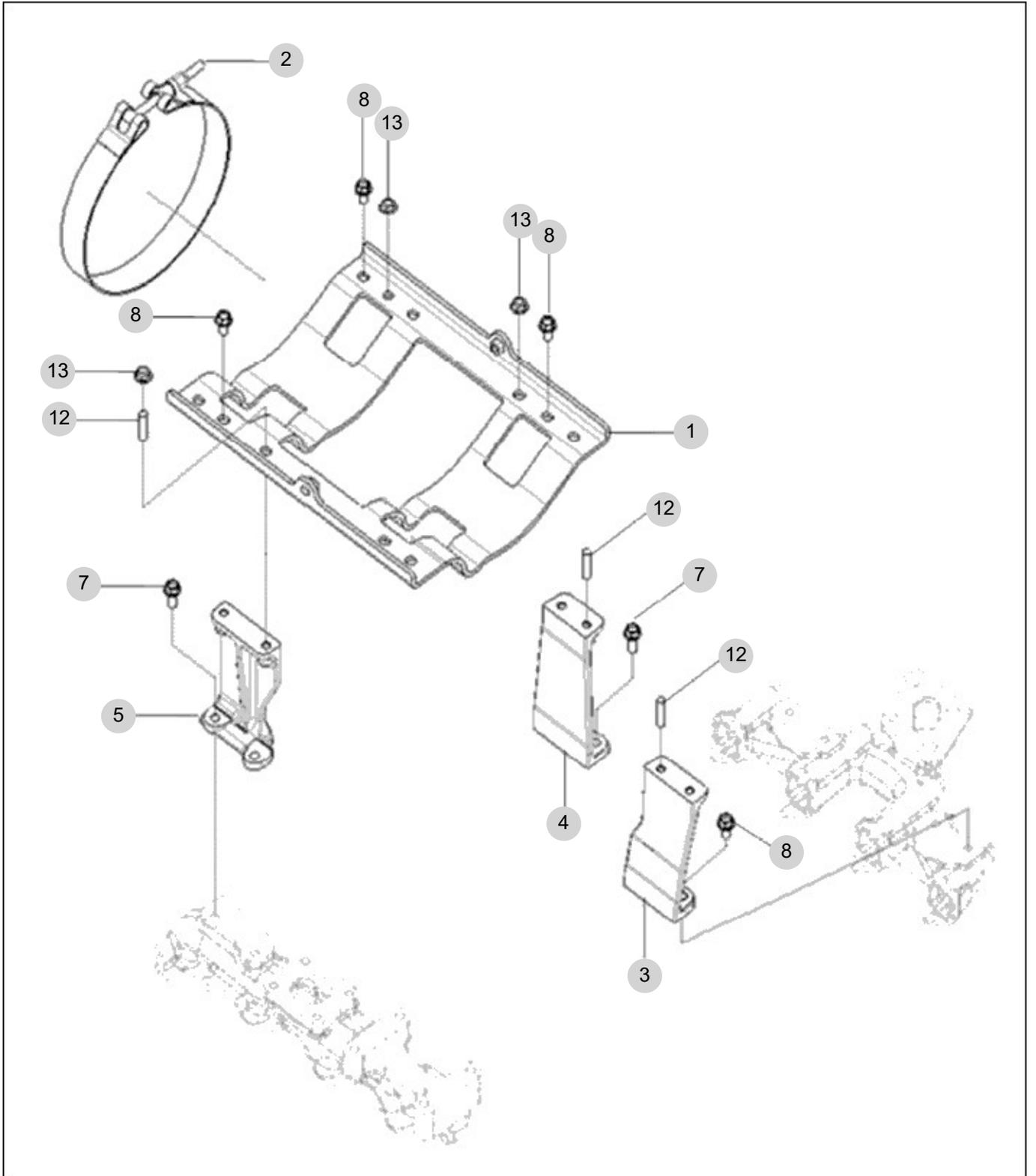

NOTE



FIG 140

T574ST-B

DATAPLATE

년/월  
Year/Month

2022-12

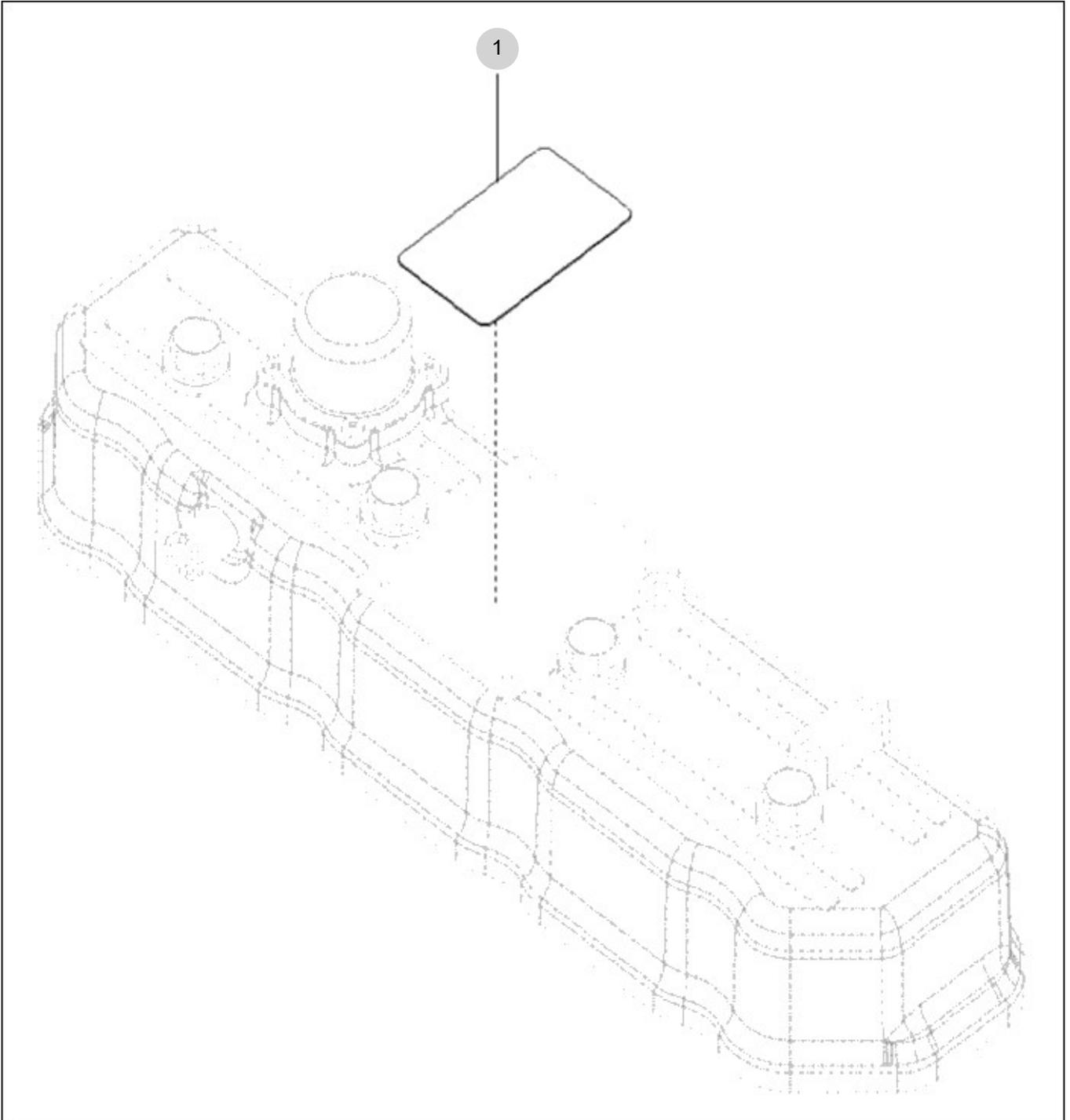

NOTE









FIG 143

T574ST-B

LIFT ASS'Y

년/월  
Year/Month

2022-12

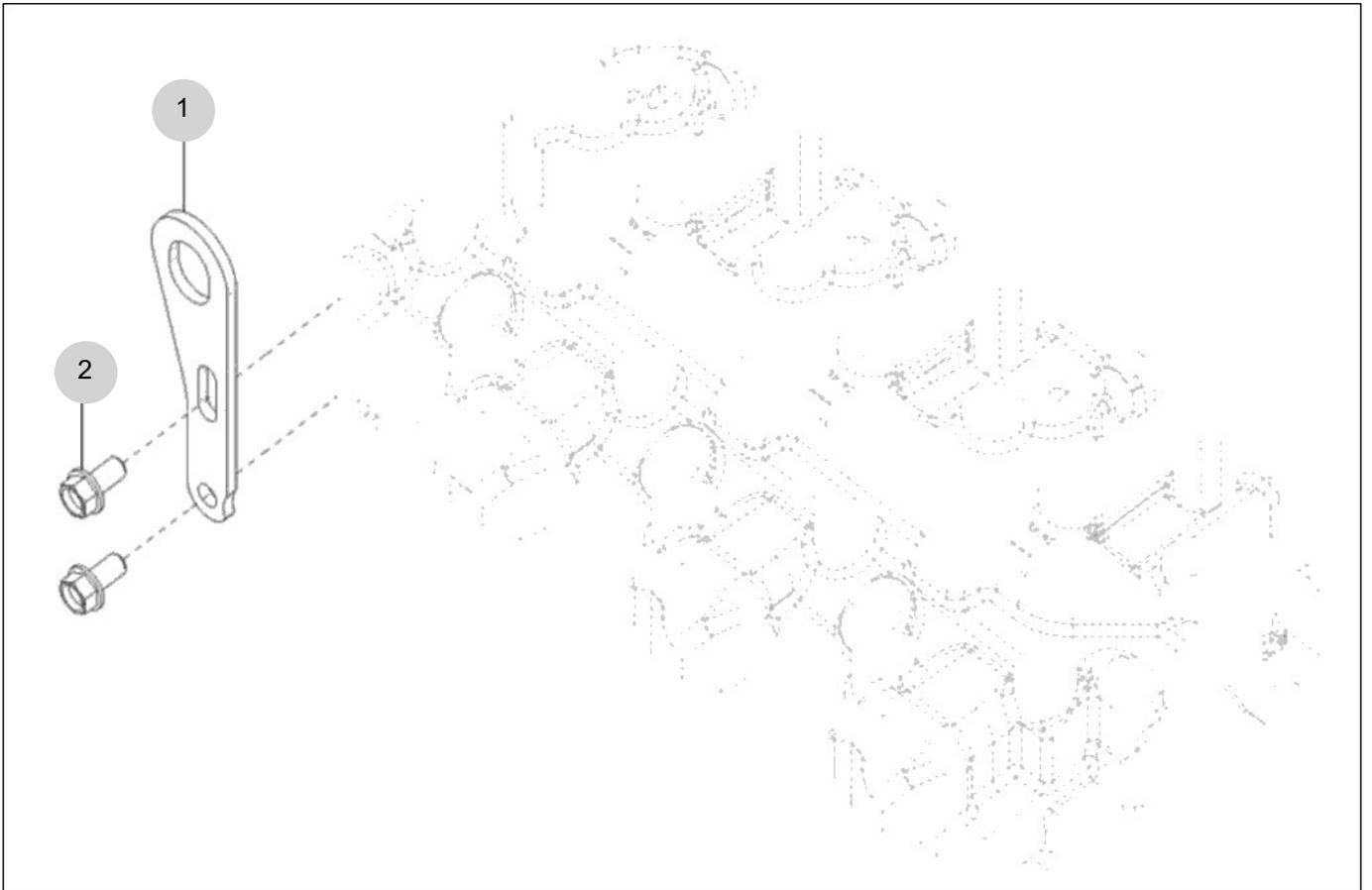

NOTE



FIG 144

COMP . DRIVE PULLEY ASS'Y OPTION

년/월  
Year/Month

T574ST-B

2022-12

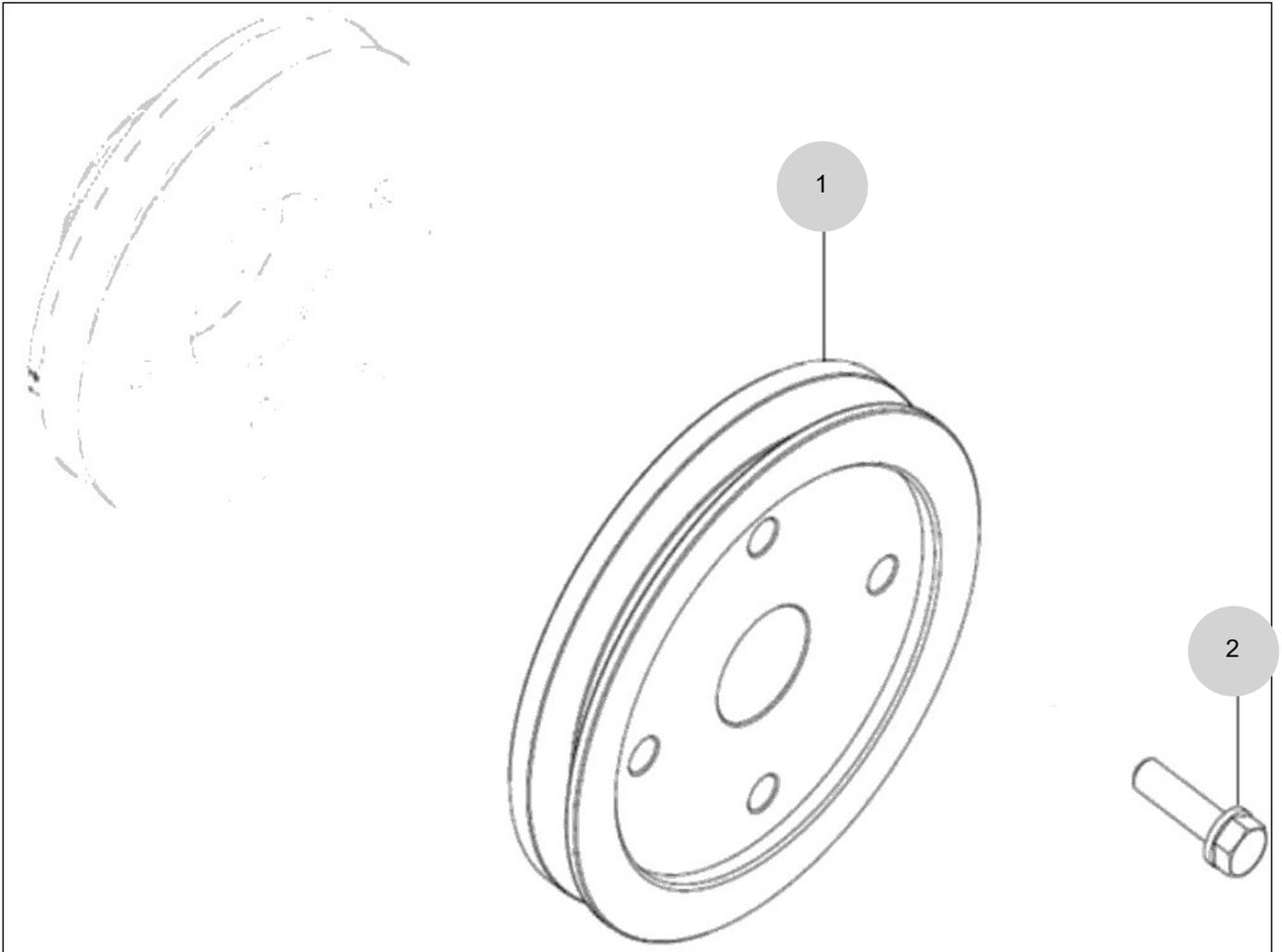

NOTE



FIG 145

T574ST-B

INTAKE PIPE

년/월  
Year/Month

2022-12

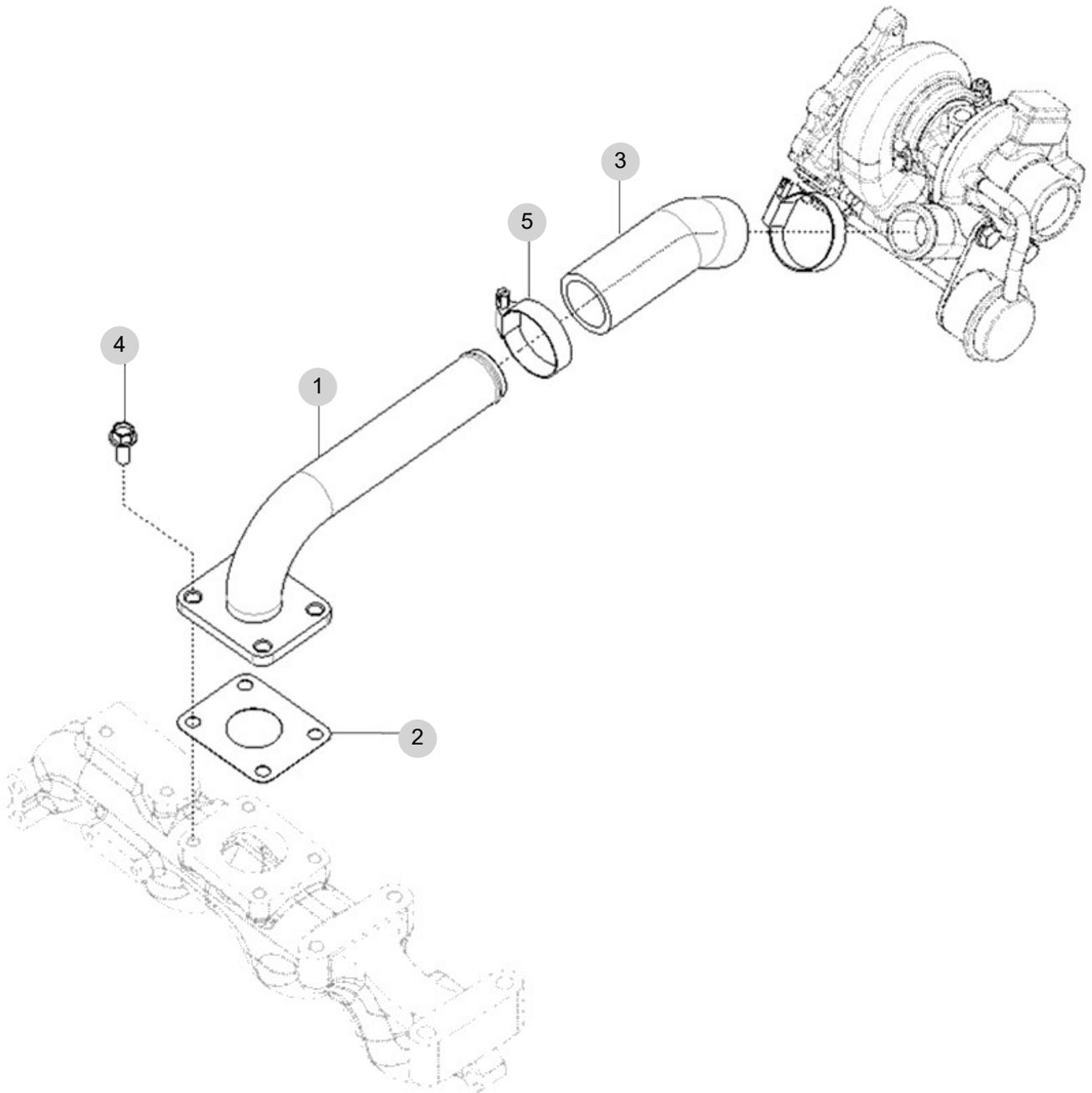

NOTE



FIG 146

T574ST-B

CCV ASS'Y

년/월  
Year/Month

2022-12

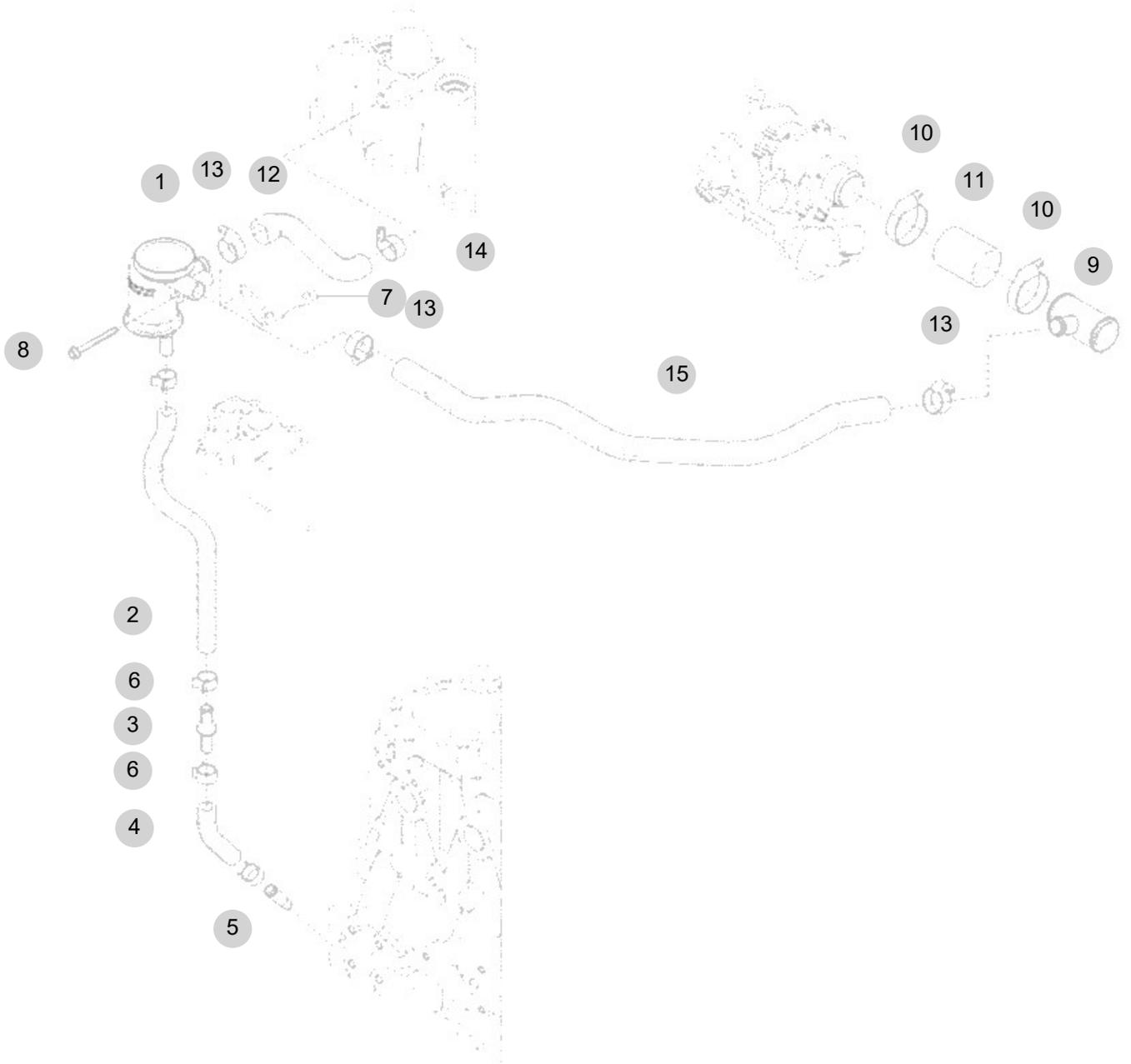

NOTE





FIG 147

T574ST-B

LOOSED PARTS

년/월  
Year/Month

2022-12

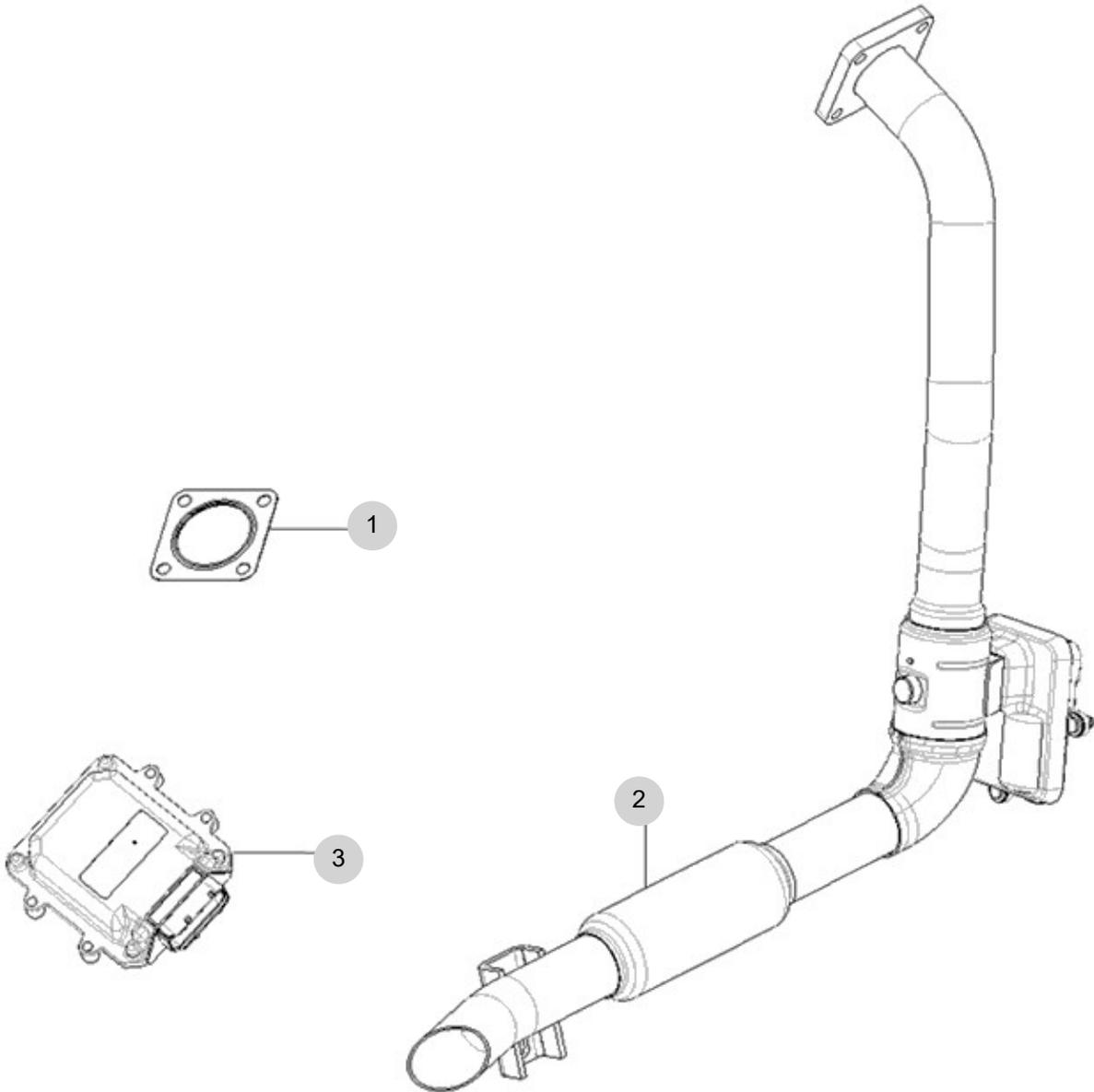

NOTE



## 2. Engine Accessories PART NO. T2

FIG 201A AIR CLEANER (T574)	109
FIG 202 RADIATOR	111
FIG 203 MUFFLER	113
FIG 204 FUEL HOSE & FILTER	115
FIG 205 FUEL TANK	117
FIG 206 ACCELERATOR	119





FIG 202

RADIATOR

년/월  
Year/Month

2022-12

T574ST-B

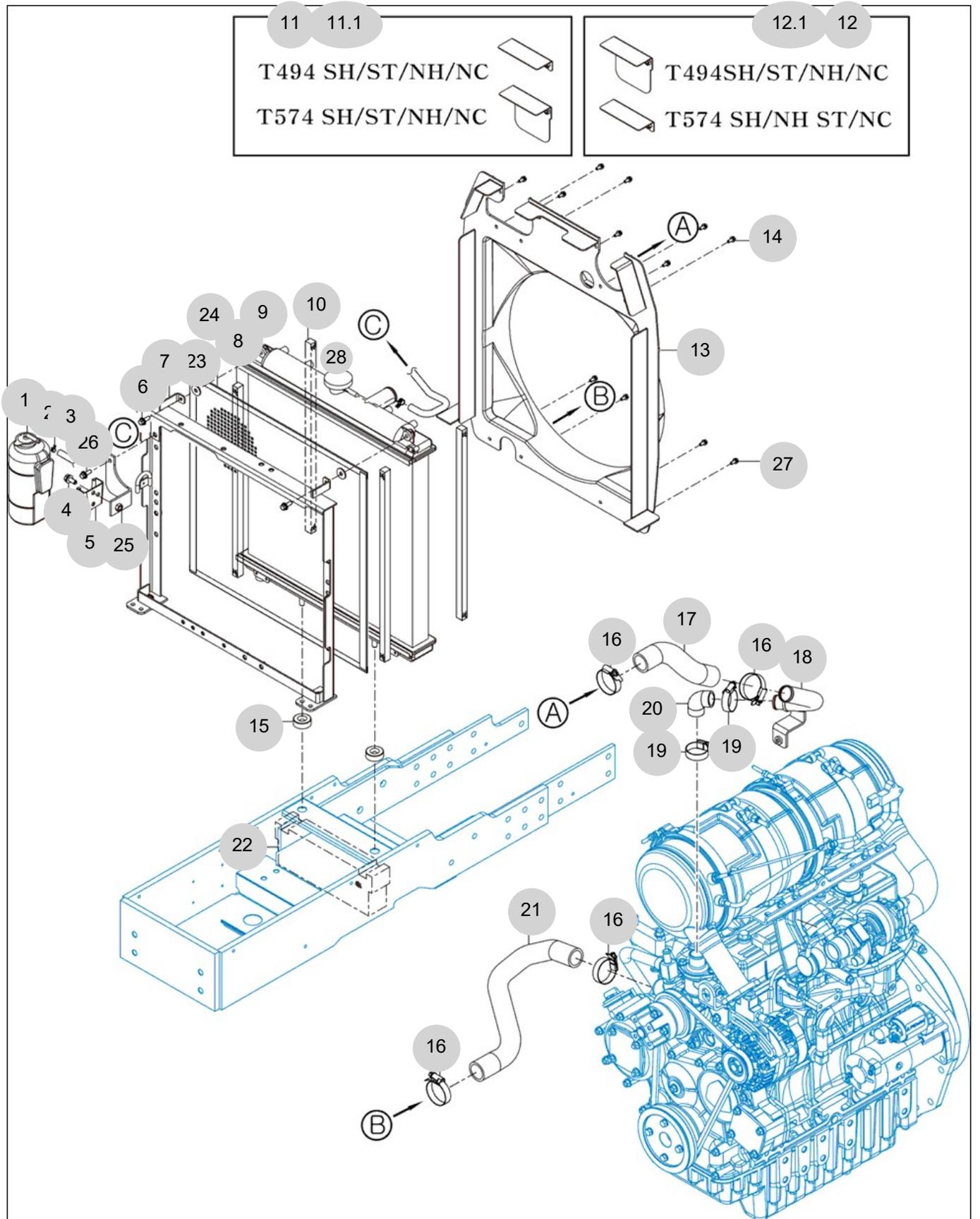

NOTE





FIG 203

MUFFLER

년/월  
Year/Month

2022-12

T574ST-B

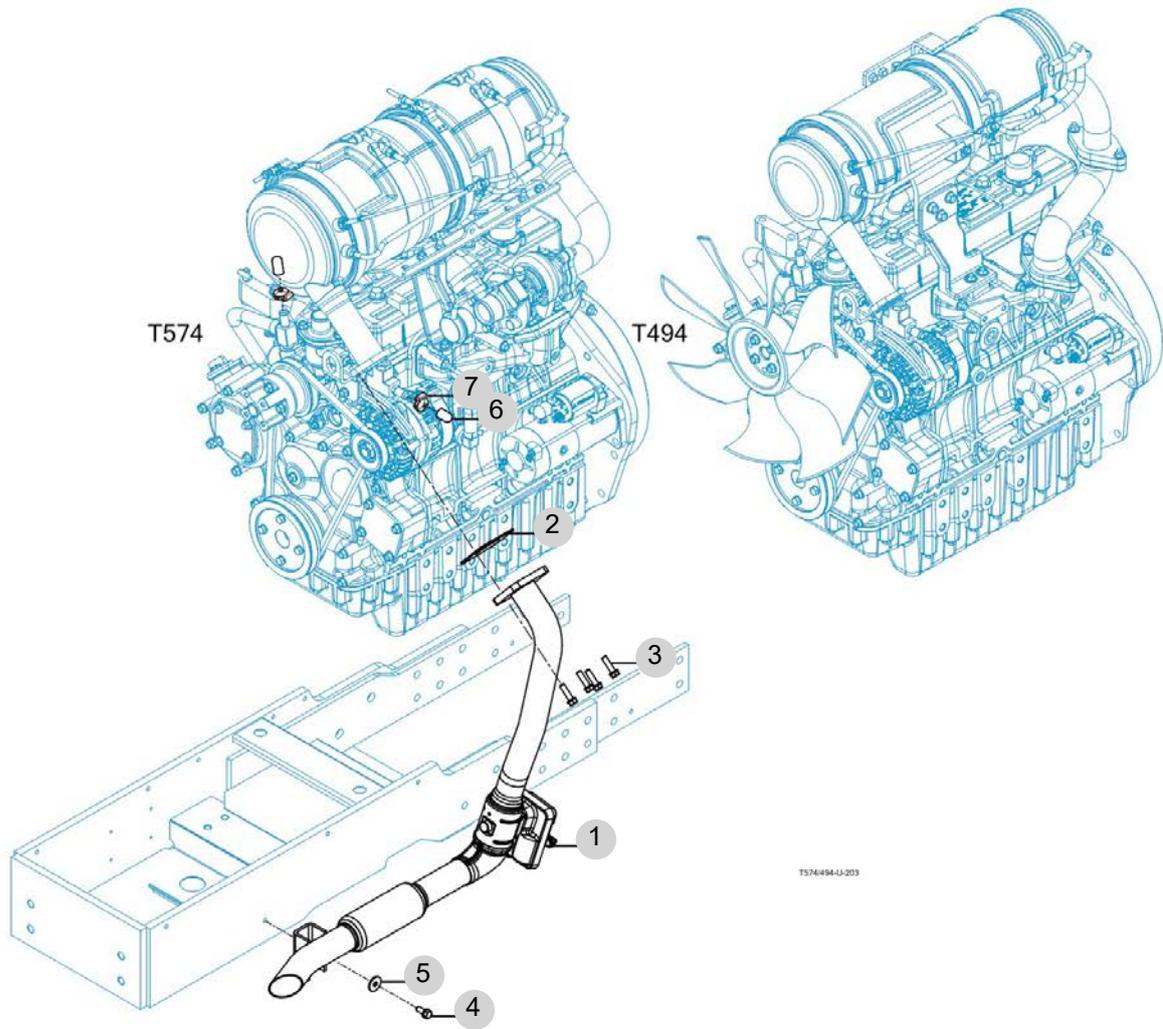

NOTE



FIG 204

FUEL HOSE & FILTER

년/월  
Year/Month

T574ST-B

2022-12

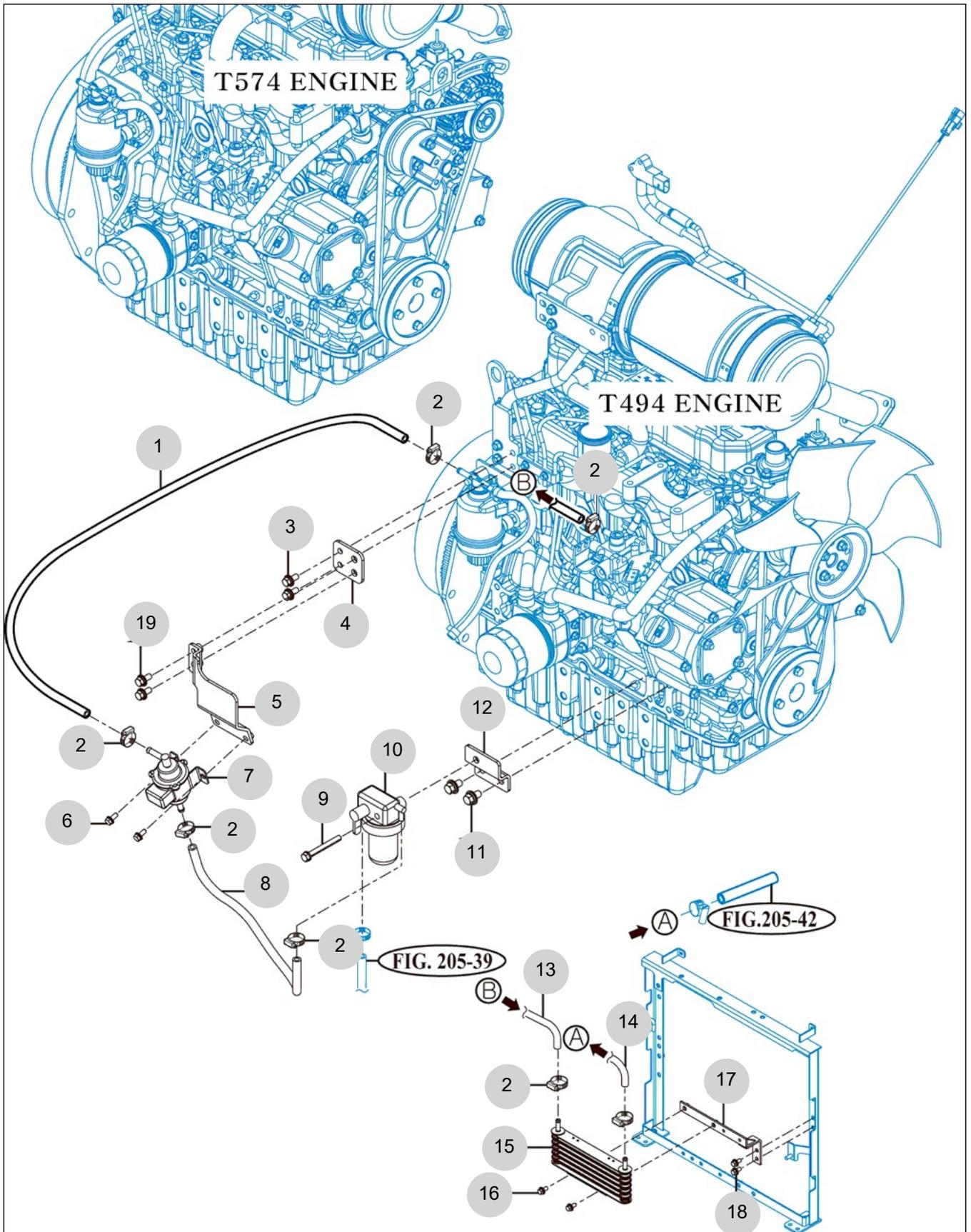

NOTE







FIG 206

ACCELERATOR

년/월  
Year/Month

2022-12

T574ST-B

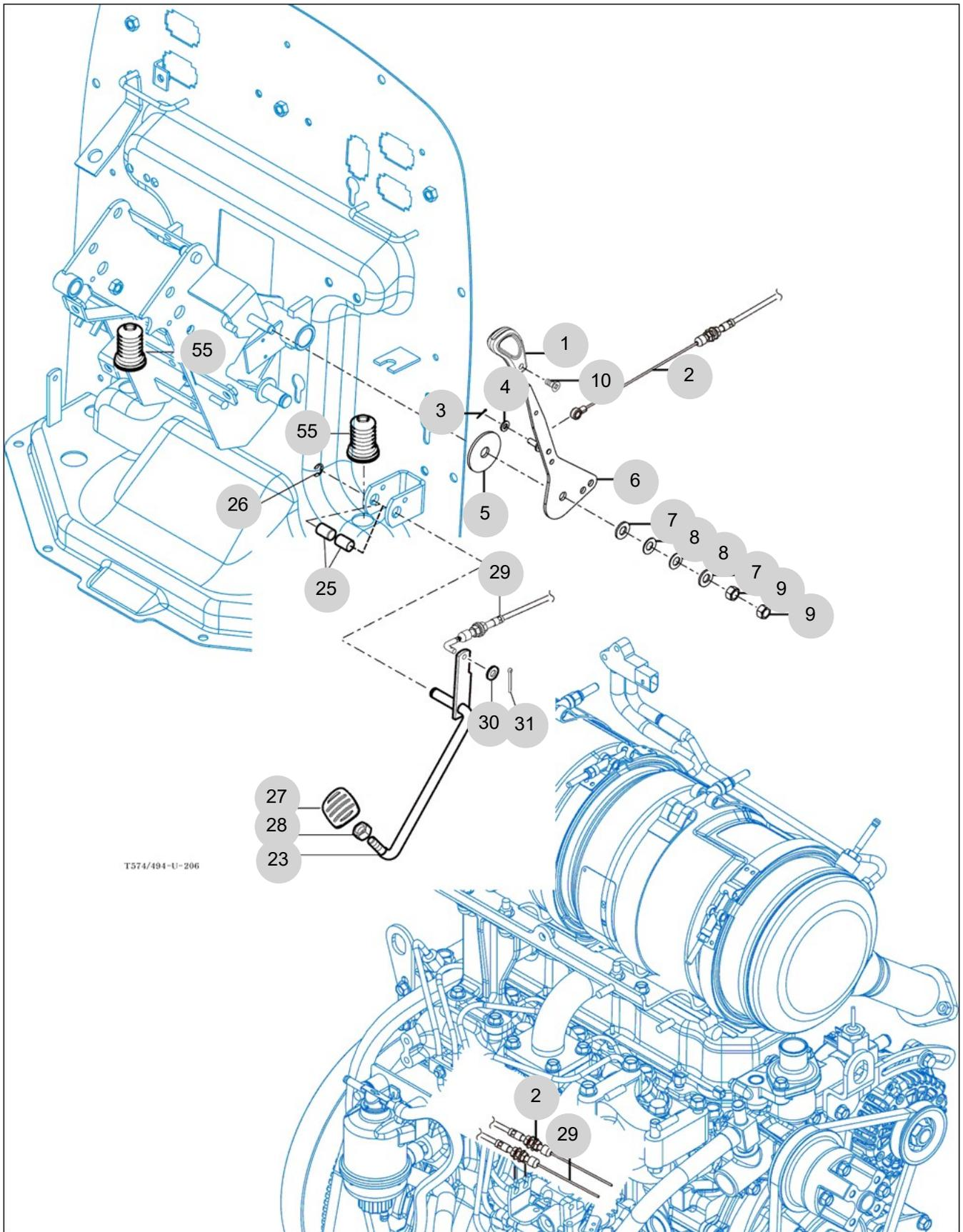

NOTE





### 3. Clutch/Brake/Steering PART NO. T3

FIG 301 CLUTCH	122
FIG 302 CLUTCH PEDAL	124
FIG 303 BRAKE	127
FIG 304 BRAKE PEDAL & LINK	129
FIG 305 FRONT WHEEL	131
FIG 306 REAR WHEEL	133
FIG 307 POWER STEERING WHEEL	135
FIG 308 POWER STEERING VALVE	137
FIG 309 POWER STEERING CYLINDER	139

FIG 301

T574ST-B

CLUTCH

년/월  
Year/Month

2022-12

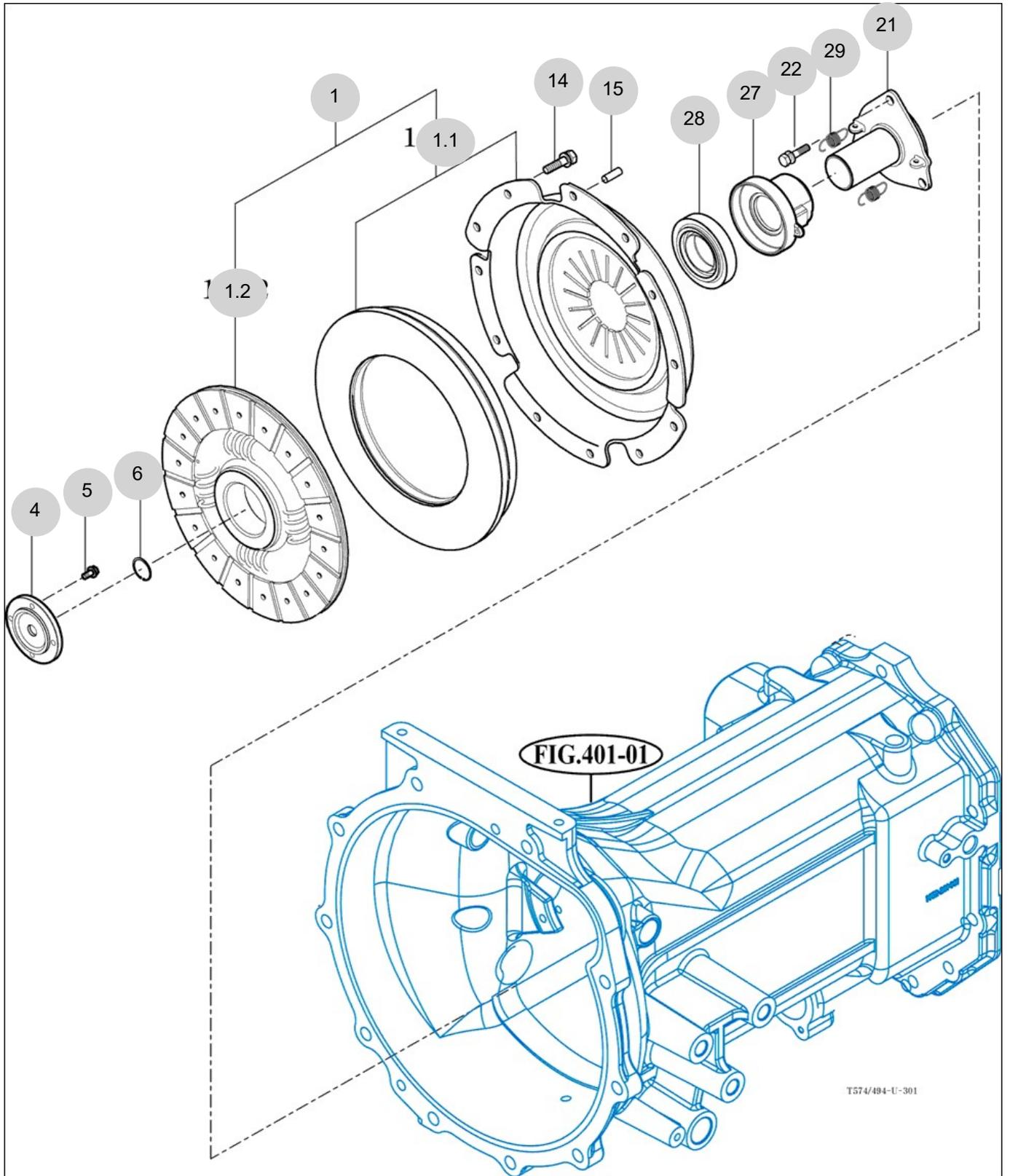

NOTE



FIG 302

CLUTCH PEDAL

년/월  
Year/Month

2022-12

T574ST-B

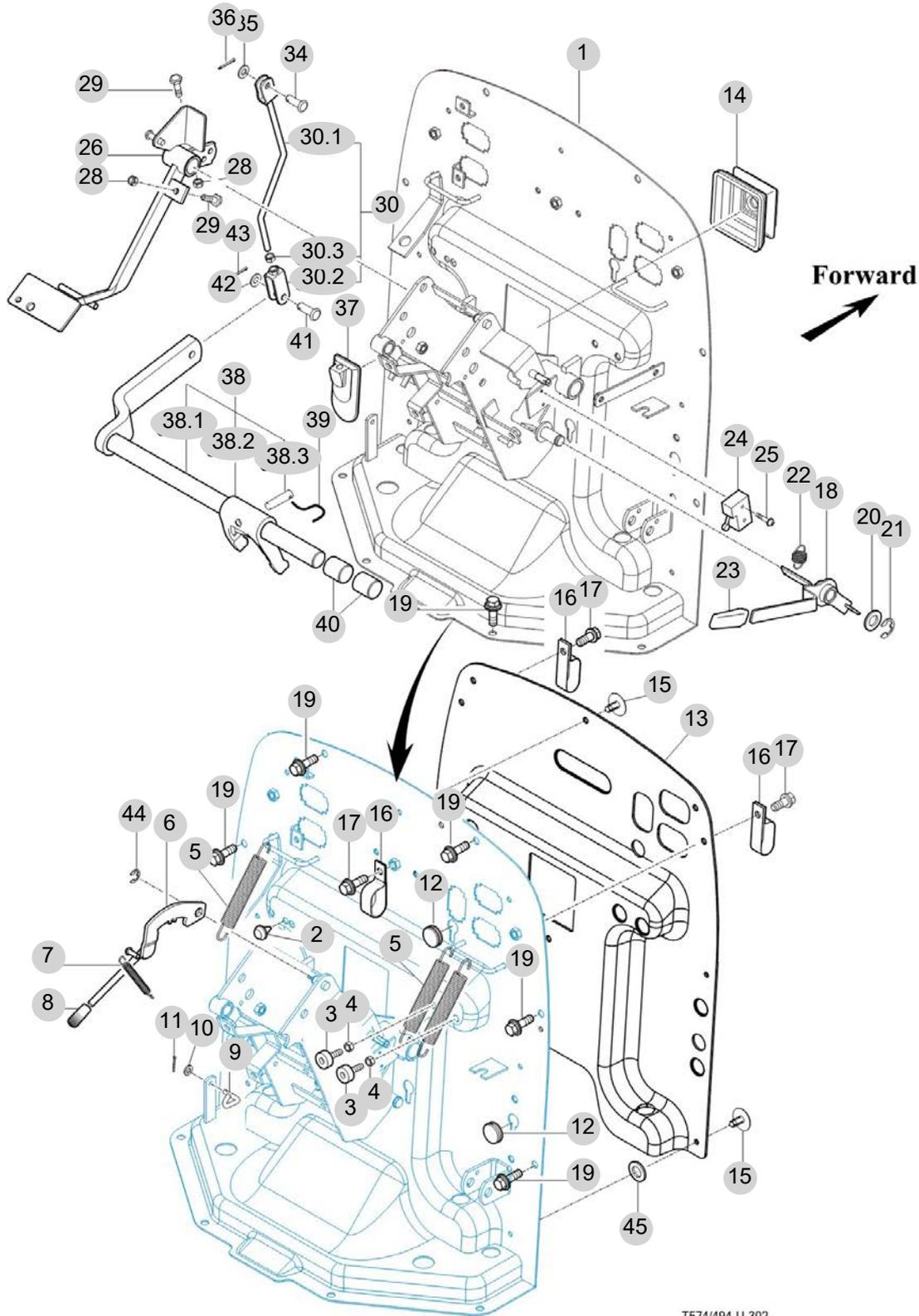

T574/494-U-302

NOTE

FIG 302		CLUTCH PEDAL						년/월 Year/Month	
								2022-12	
T574ST-B		KEY NO	PART NO	DESCRIPTION	SPEC	QTY	REPAIR	EFFECTIVE DATE	REMARKS
302	1	13866303200GB	DASH PANEL COMP			1			
302	2	14326160020	RUBBER , CUSHION	1X1X1		1			
302	3	14216020051	RUBBER , CUSHION B	1X1X1		2			
302	4	V3043600080	NUT , HEX/2	M8		2			
302	5	14041200080	RETURN SPRING , CLUTCH	HL2000공용		3			
302	6	14724042401GB	LEVER COMP , TILT	1X1X1		1			
302	7	16001200080	RETURN SPRING , BRAKE	1X1X1		1			
302	8	21615250020	GRIP , LEVER/RED			1			
302	9	15441230050	ROD	D=5.25 5.3		1			
302	10	V4111600060	WASHER , PLAIN	M6		1			
302	11	V5001920020	PIN , SPLIT	2X20		1			
302	12	14326510210	CAP , RUBBER 20	1X1X1		2			
302	13	17467071991	INSULATOR , DASH	T=10		1			
302	14	14526300011	BOOT,STEERING/HOSE	T=1.5		1			
302	15	17686040020	RIVET SET , black	SV625		9			
302	16	14441010161	CLAMP , RADIATOR HOSE	1X1X1		3			
302	17	V2183608020	BOLT , HEX/SP	M8X20		3			
302	18	14523293301GB	LEVER COMP,PARKING	1X1X1		1			
302	19	V2183608016	BOLT , HEX/SP	M8X16		10			
302	20	V4111600160	WASHER , PLAIN	M16		1			
302	21	V7081400150	E-RING	15		1			
302	22	14321200040	SPRING , TENSION 31	D=1.2		1			
302	23	34523030020	GRIP , THROTTLE	1X1X1		1			
302	24	16756214701	SWITCH ASSY , SAFETY	1X1X1		1			
302	25	V1222604025	SCREW , C/R PAN/SP	M4X25		2			
302	26	14571332100GB	PEDAL COMP , CLUTCH	1X1X1		1			
302	28	V3043600080	NUT , HEX/2	M8		2			
302	29	V2013608030	BOLT , HEX	M8X30		2			
302	30	14521330002GB	ROD SUB , CLUTCH			1			
302	30	14521330002	ROD SUB , CLUTCH	398*87		1			
302	30	14521330002	ROD SUB , CLUTCH			1			
302	30.1	14521333103	ROD COMP, CLUTCH	346*87		1			
302	30.2	14521333200	HOOK COMP	1X1X1		1			
302	30.3	V3042600080	NUT , HEX/2	M8		1			
302	34	14322420010	PIN	D=8		1			
302	35	V4111600080	WASHER , PLAIN	M8		1			
302	36	V5001925020	PIN D2.5x20	2.5X20		1			
302	37	14526300210	BOOT,CLUTCH PEDAL	1X1X1		1			
302	38	14521302000	BAR SET	1X1X1		1			
302	38.1	14521302101	BAR COMP			1			
302	38.2	14521300011	FORK , RELEASE	1X1X1		1			
302	38.3	15601300010	PIN , 08X40	1X1X1		1			
302	39	V5901012150	WIRE , STEEL	1.2X150		1			
302	40	14521302150	BUSH , BAR COMP	1X1X1		2			
302	41	14043120060	PIN , YOKE	D=8		1			
NOTE									



FIG 303

BRAKE

년/월  
Year/Month

T574ST-B

2022-12

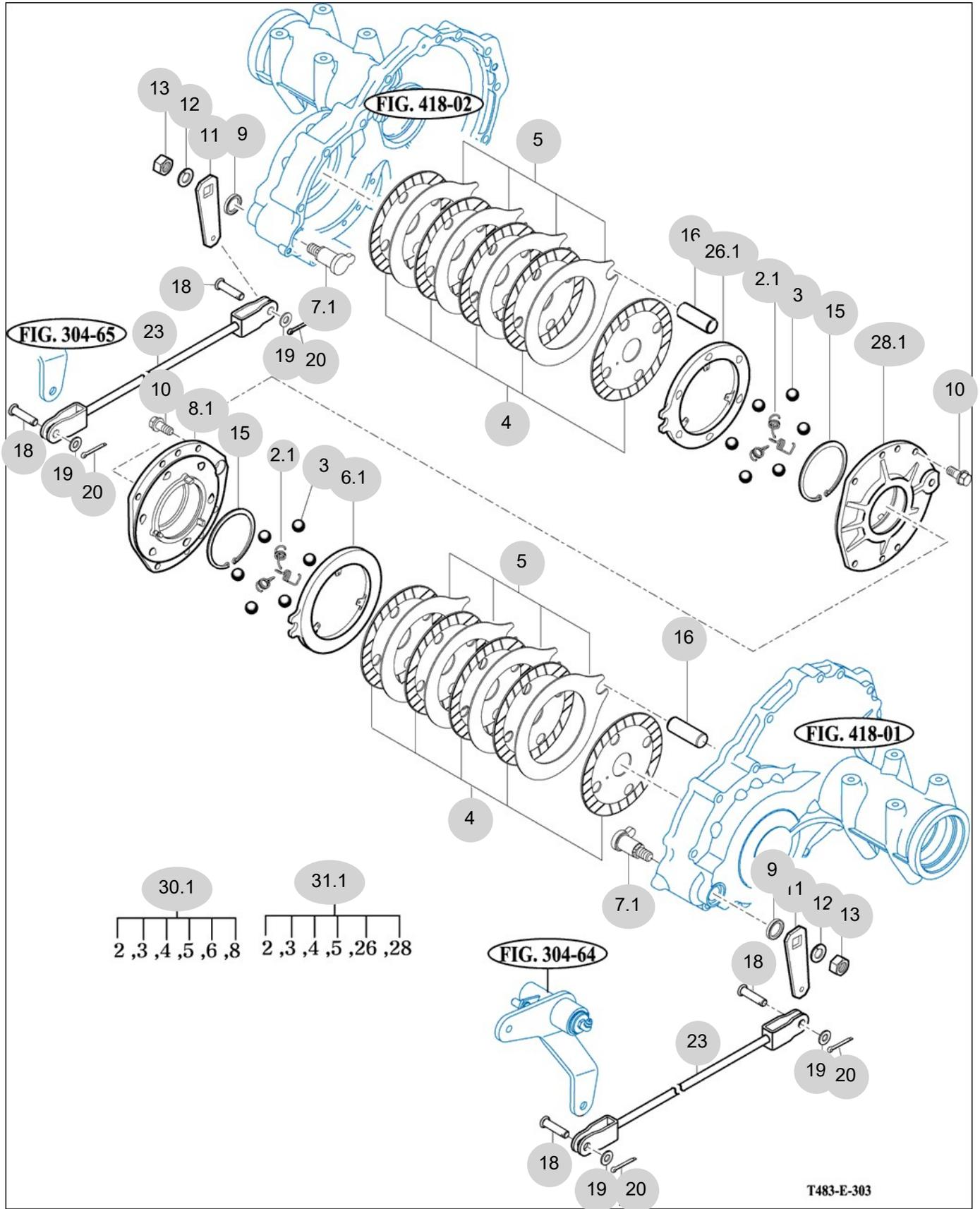

T483-E-303

NOTE





FIG 304

BRAKE PEDAL & LINK

년/월  
Year/Month

2022-12

T574ST-B

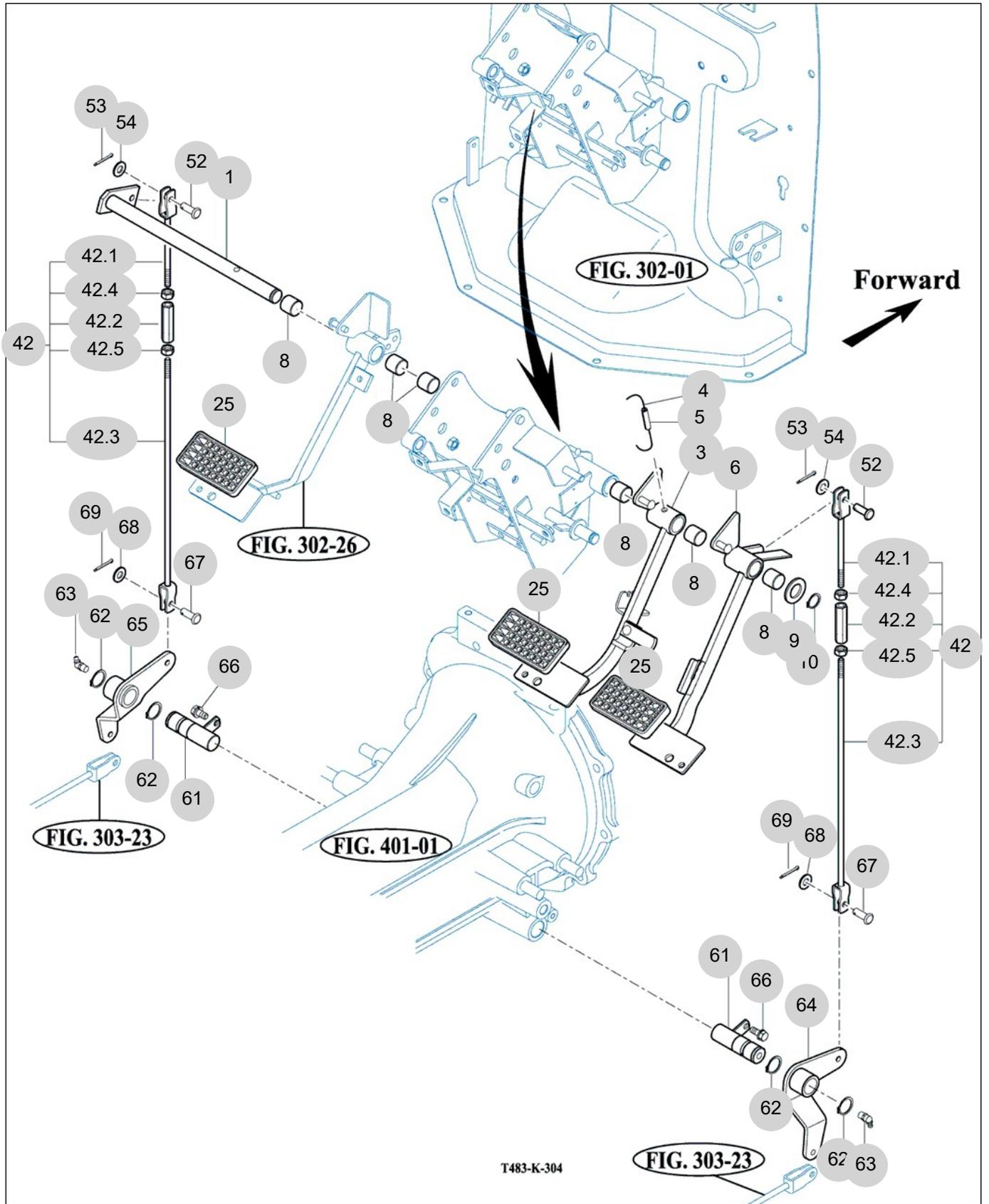

NOTE



FIG 305

T574ST-B

FRONT WHEEL

년/월  
Year/Month

2022-12

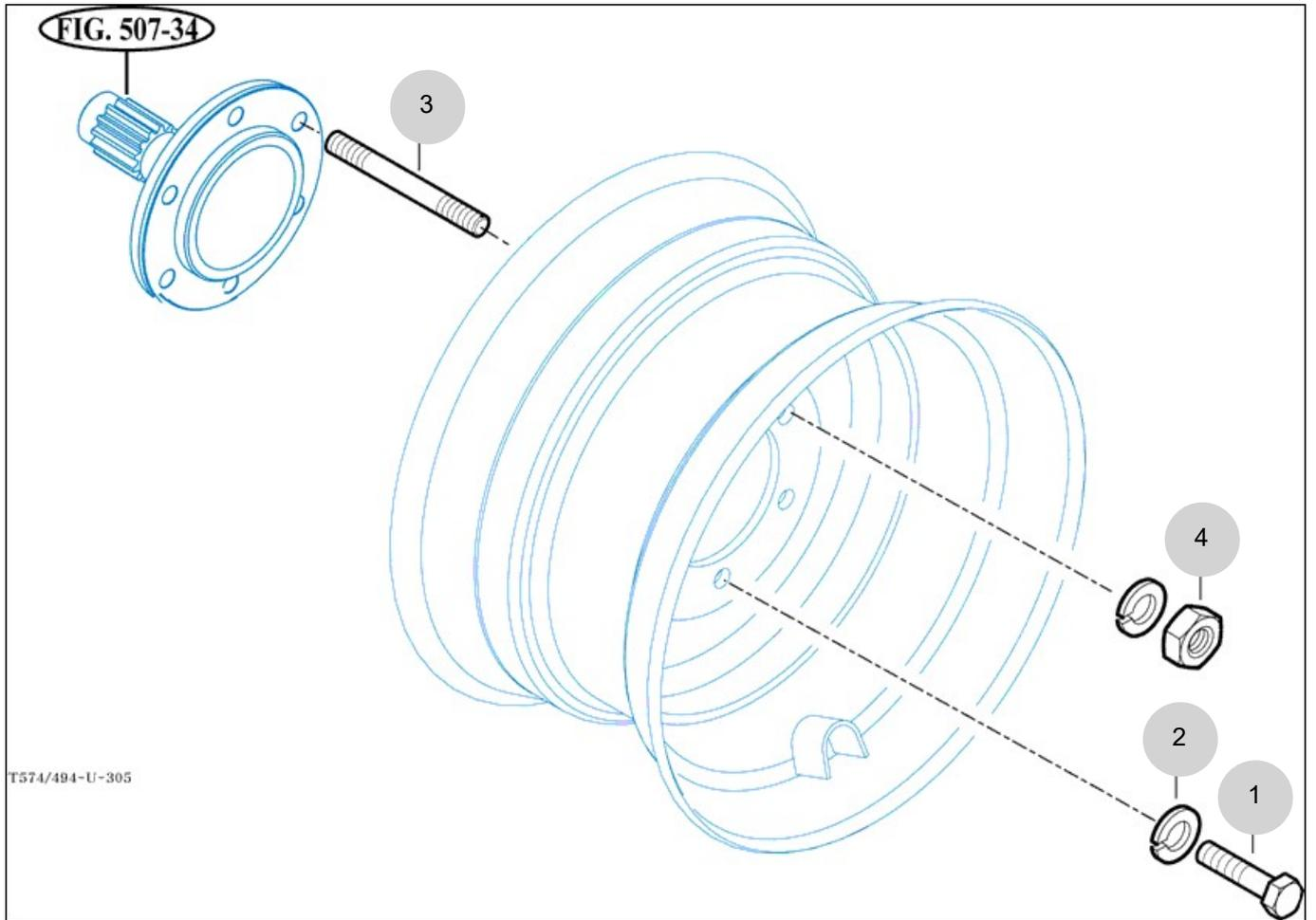

NOTE



FIG 306

T574ST-B

REAR WHEEL

년/월  
Year/Month

2022-12

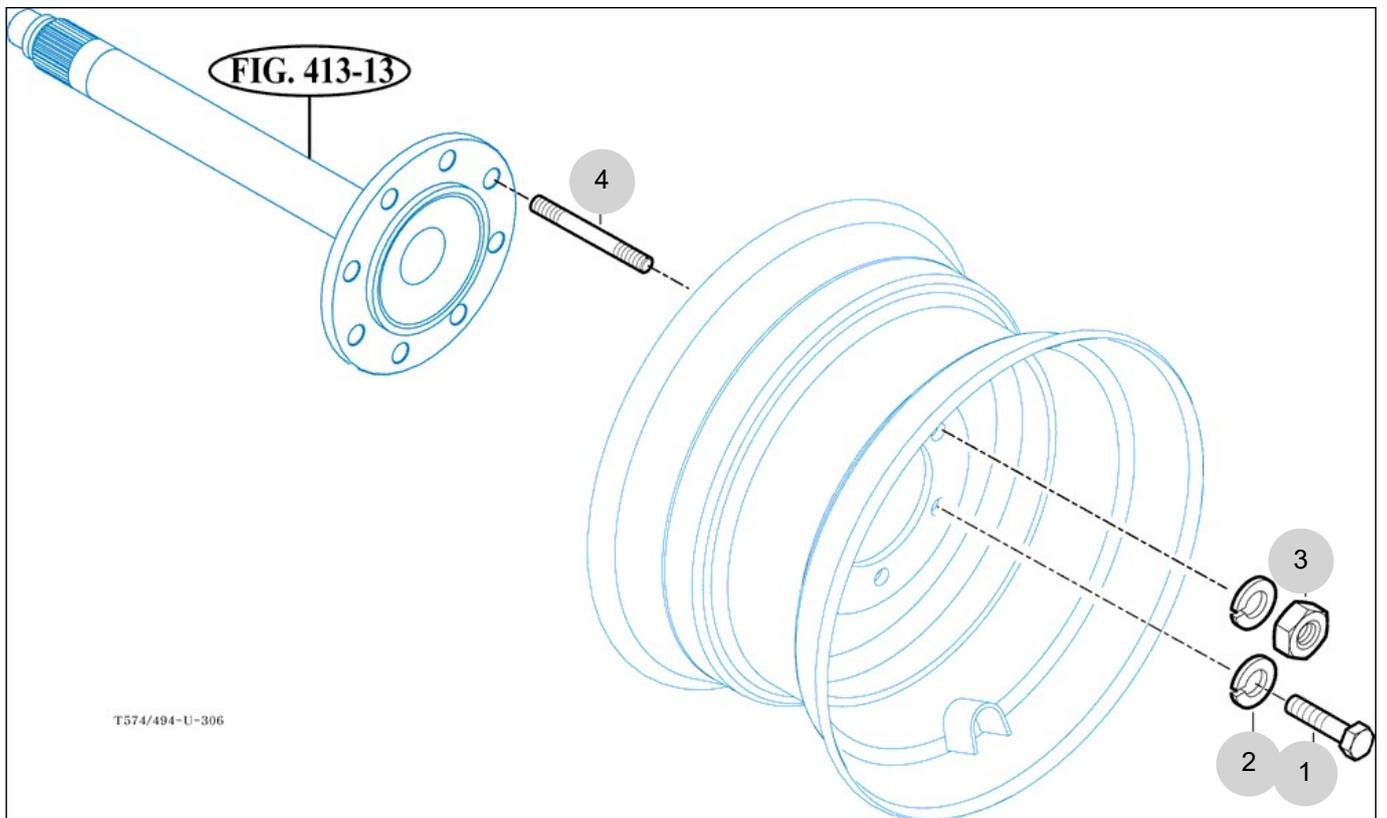

NOTE



FIG 307

T574ST-B

POWER STEERING WHEEL

년/월  
Year/Month

2022-12

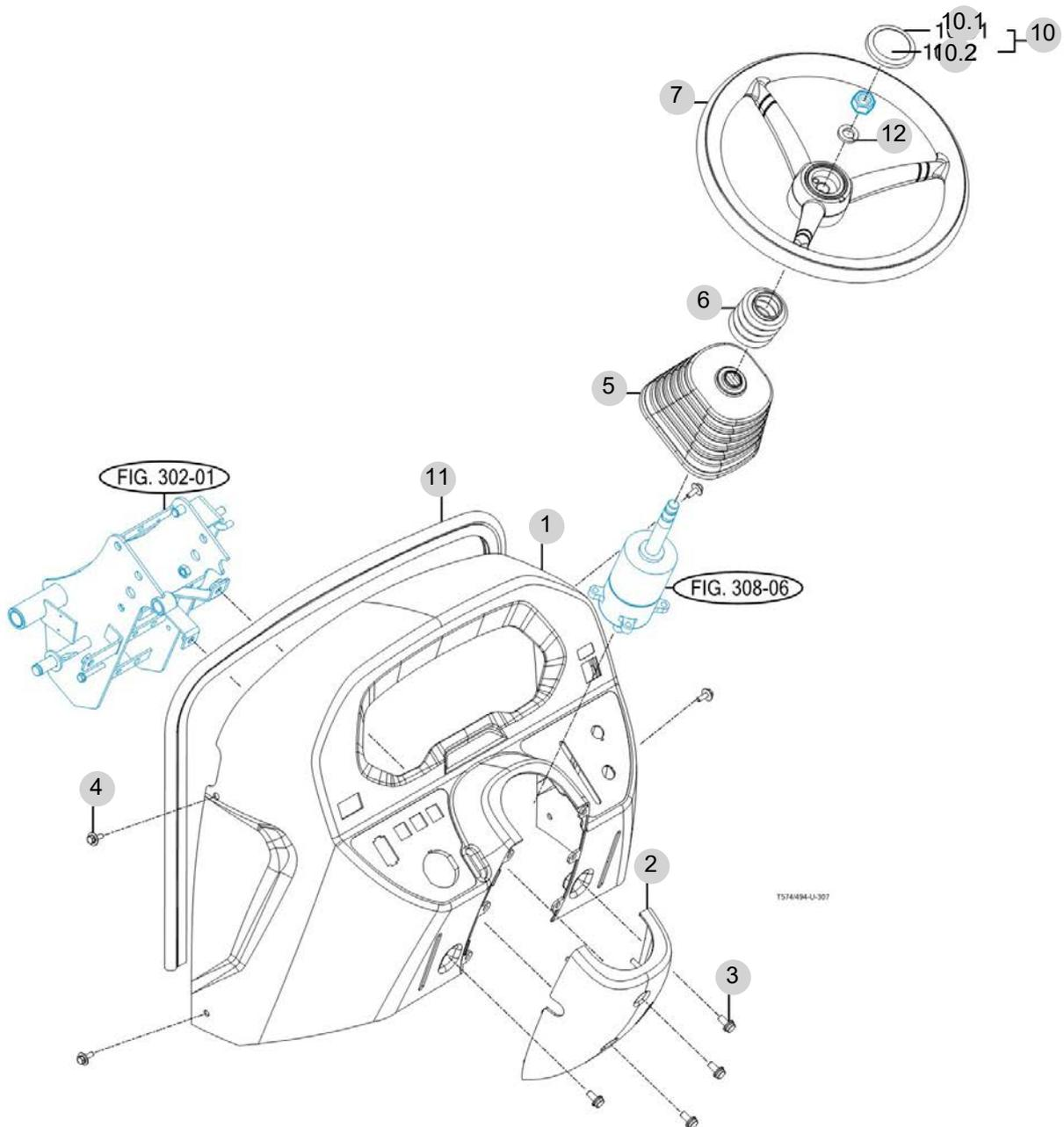

NOTE





FIG 308

T574ST-B

POWER STEERING VALVE

년/월  
Year/Month

2022-12

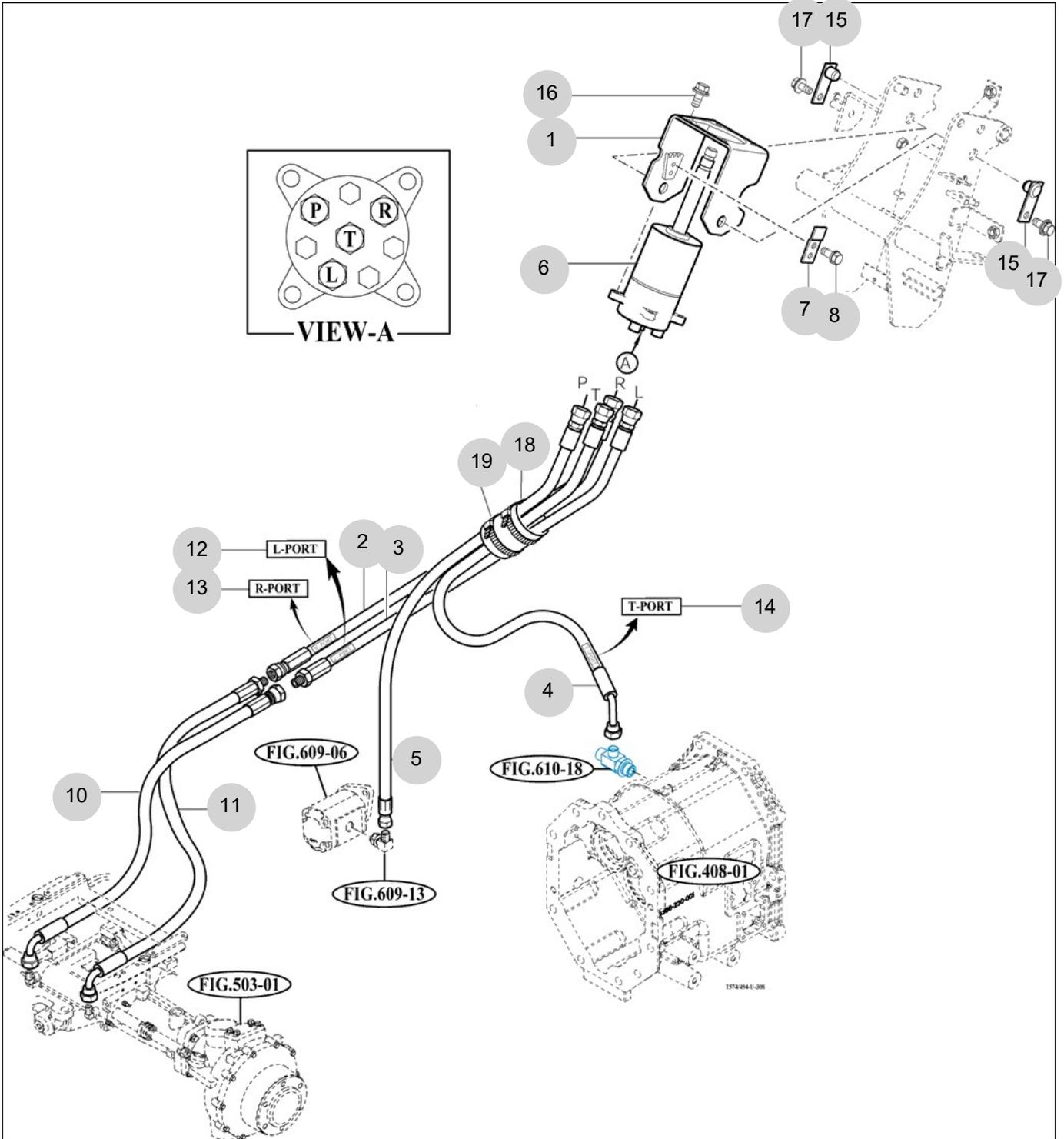

NOTE



FIG 309

T574ST-B

POWER STEERING CYLINDER

년/월  
Year/Month

2022-12

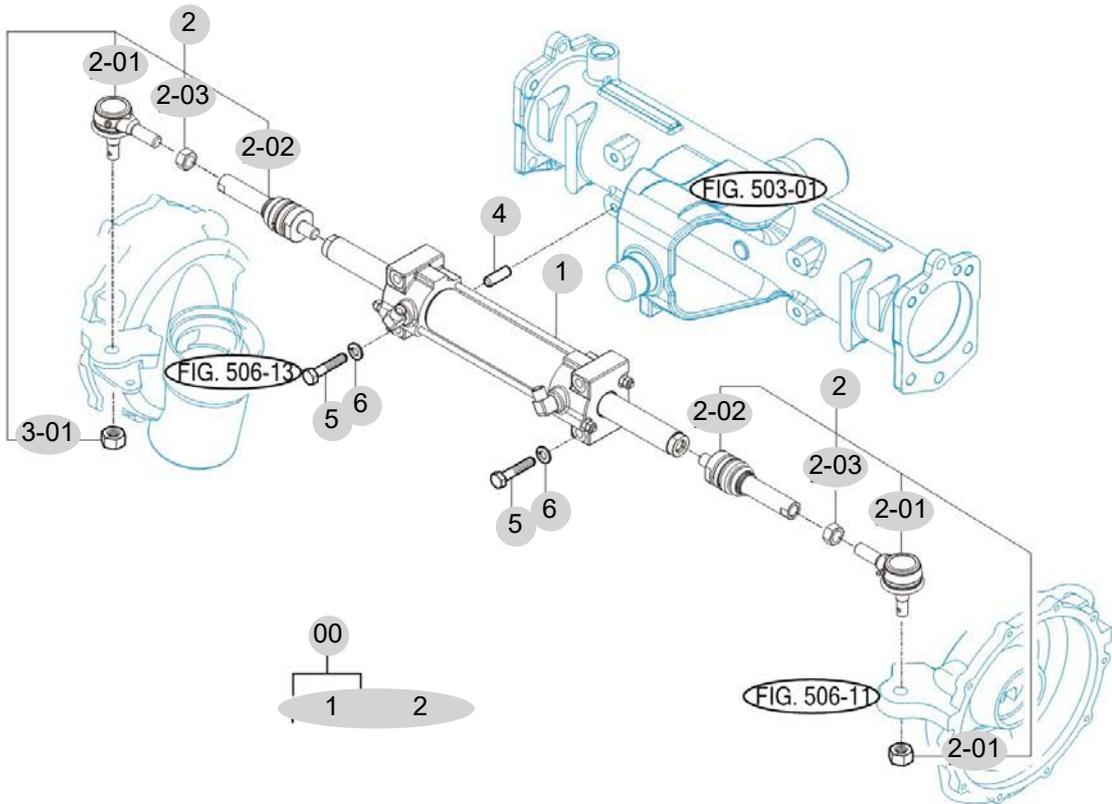

T5555T/4594C-E-309

NOTE



## 4. Transmission PART NO. T4

FIG 401 TRANSMISSION FRONT CASE	142
FIG 402 FORWARD & BACKWARD GEARS	144
FIG 403 IDLE & COUNTER GEARS	146
FIG 404 MAIN SHIFT GEARS	148
FIG 405 P.T.O DRIVE SHAFT	150
FIG 406 MAIN CHANGE LEVER	152
FIG 407 REVERSE CHANGE LEVER	154
FIG 408 TRANSMISSION MID CASE	156
FIG 409 TRANSMISSION REAR CASE	158
FIG 410 SUB CHANGE GEARS	160
FIG 411 SUB CHANGE SHIFTER	162
FIG 413 DRIVE GEARS	164
FIG 414 4WD CHANGE LEVER	166
FIG 415 P.T.O CHANGE GEARS	168
FIG 417 REAR DIFFERENTIAL GEARS	170
FIG 418 REAR AXLE HOUSING	173

FIG 401

TRANSMISSION FRONT CASE

년/월  
Year/Month

T574ST-B

2022-12

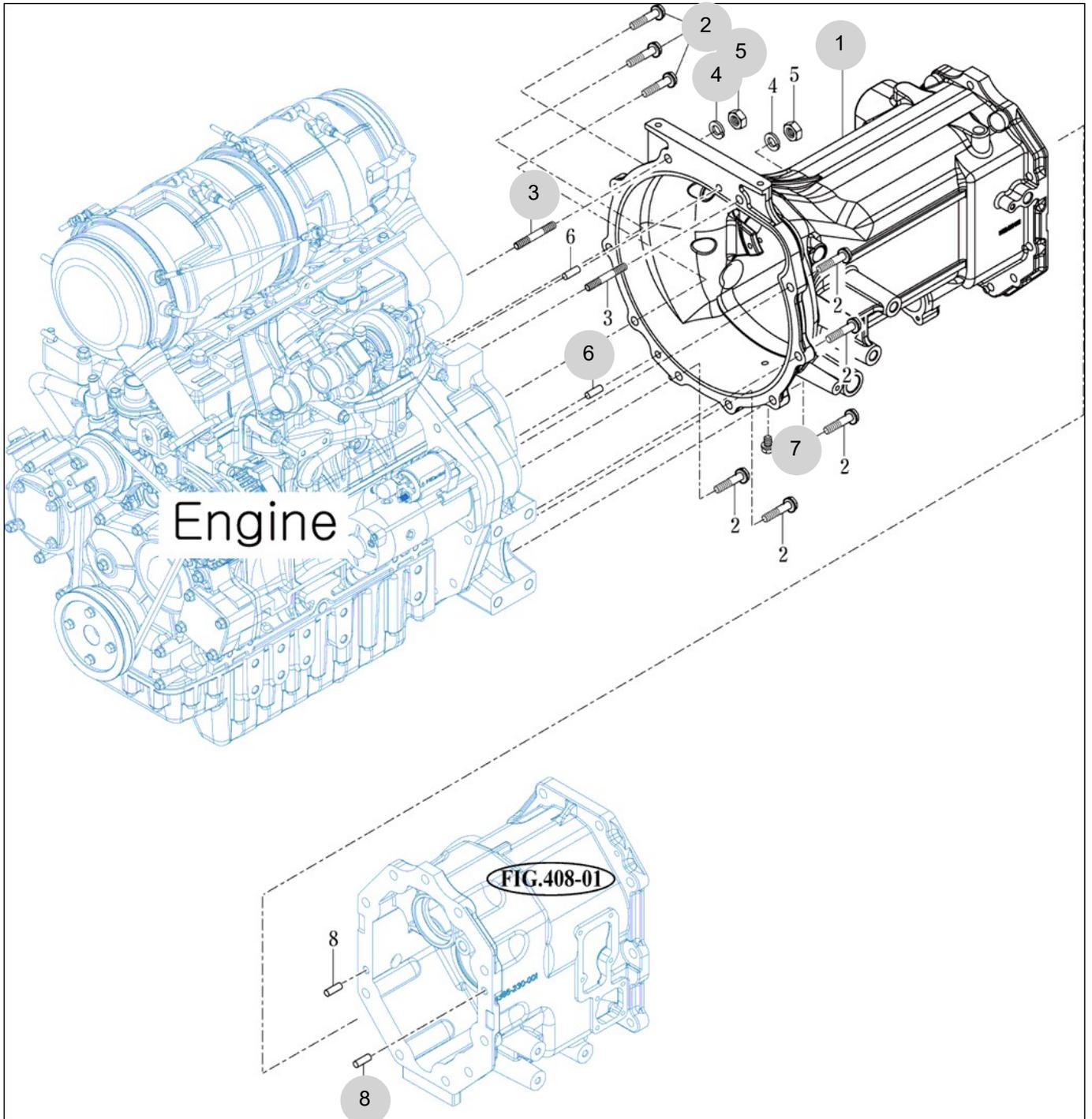

NOTE



FIG 402

FORWARD & BACKWARD GEARS

년/월  
Year/Month

T574ST-B

2022-12

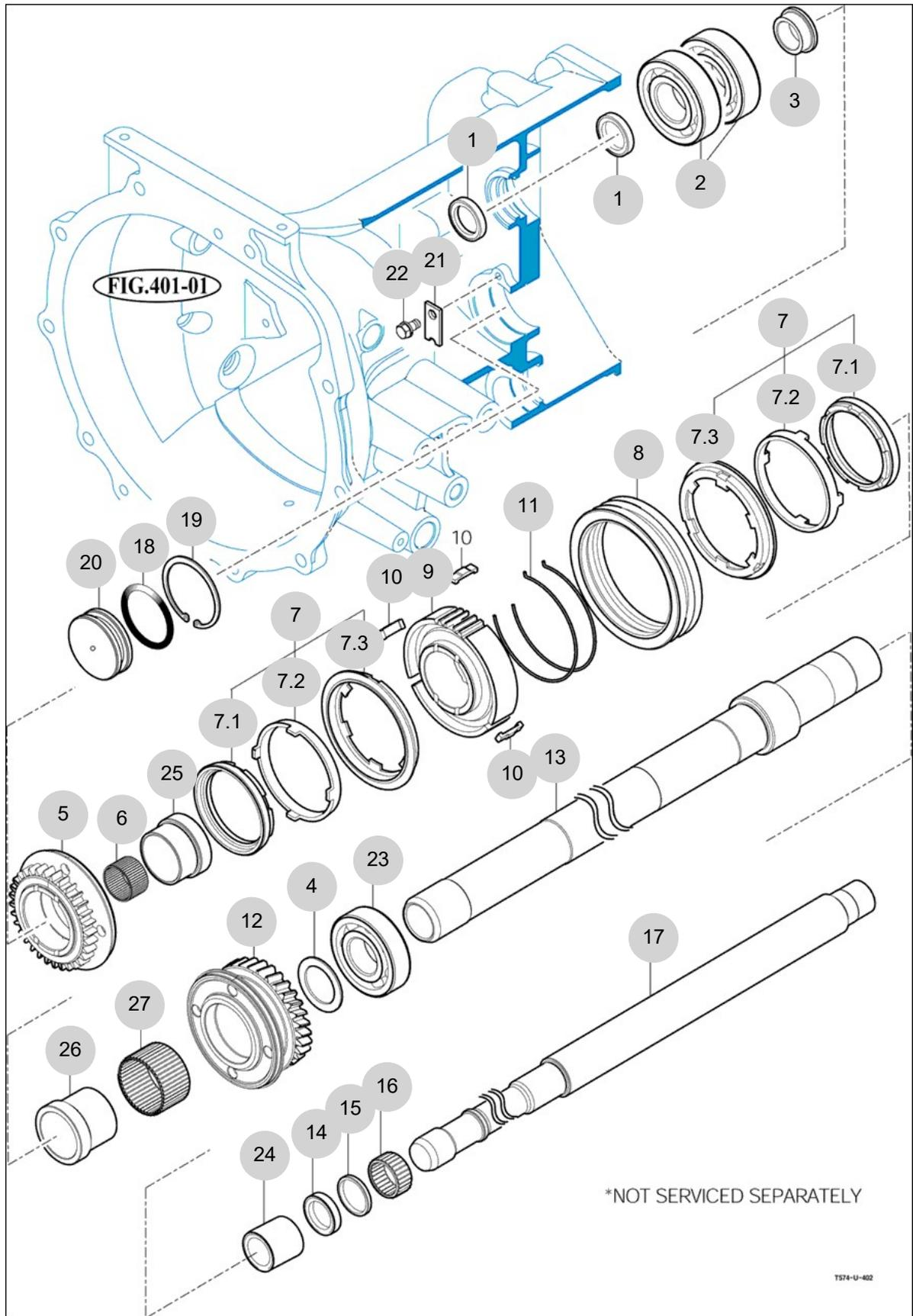

NOTE





FIG 403

IDLE & COUNTER GEARS

년/월  
Year/Month

T574ST-B

2022-12

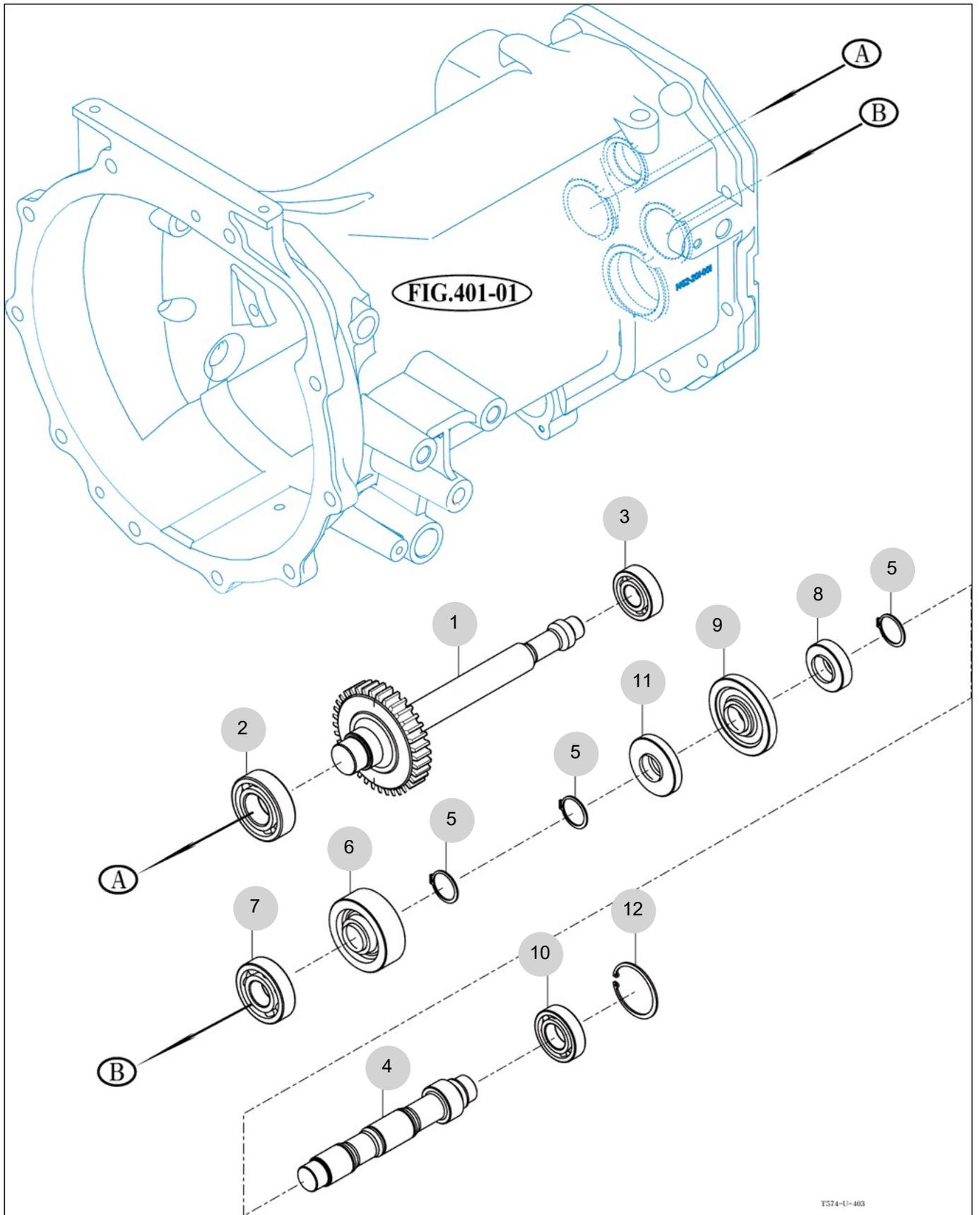

T574-U-403

NOTE



FIG 404

MAIN SHIFT GEARS

년/월  
Year/Month

T574ST-B

2022-12

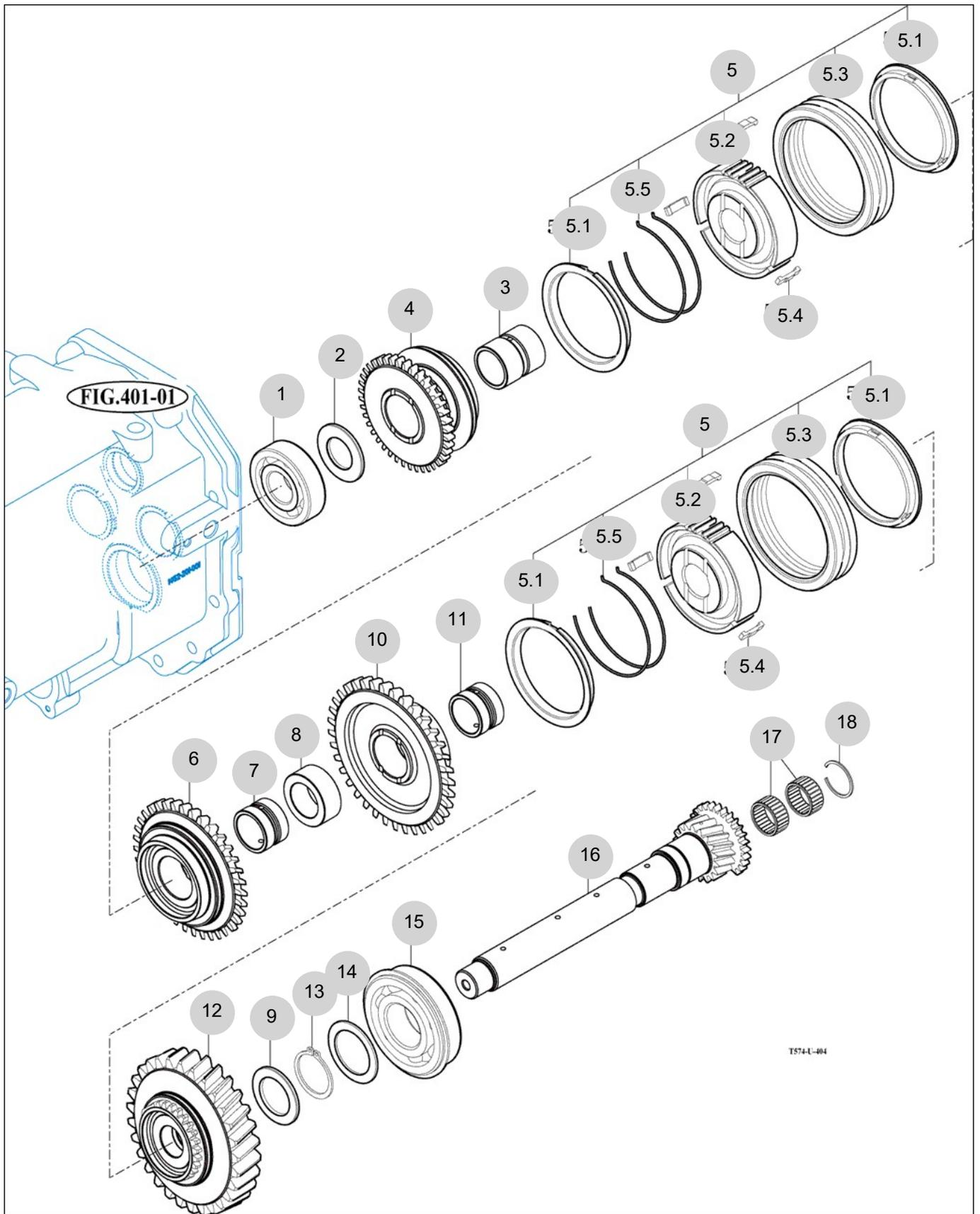

NOTE



FIG 405

P.T.O DRIVE SHAFT

년/월  
Year/Month

T574ST-B

2022-12

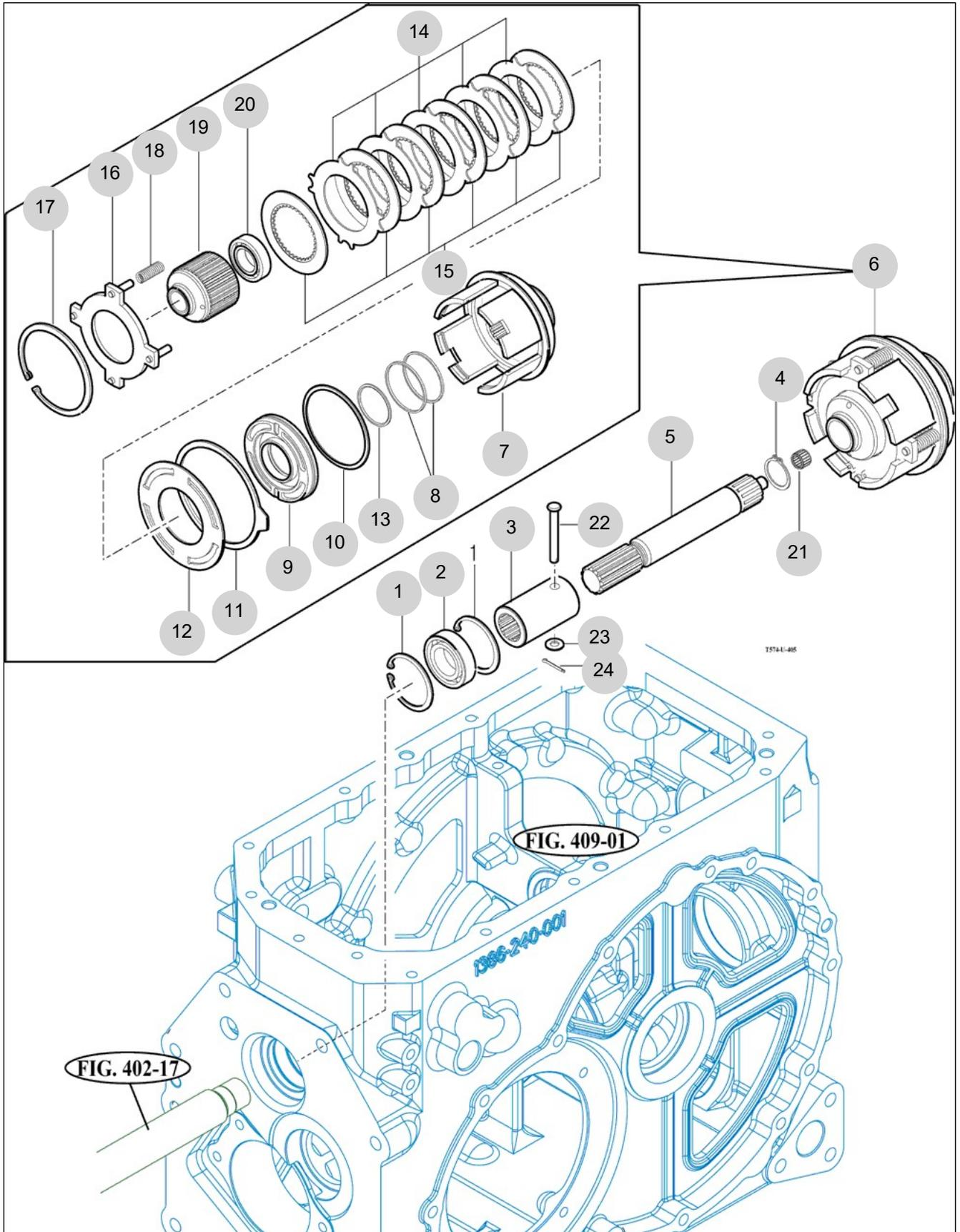

NOTE



FIG 406

T574ST-B

MAIN CHANGE LEVER

년/월  
Year/Month

2022-12

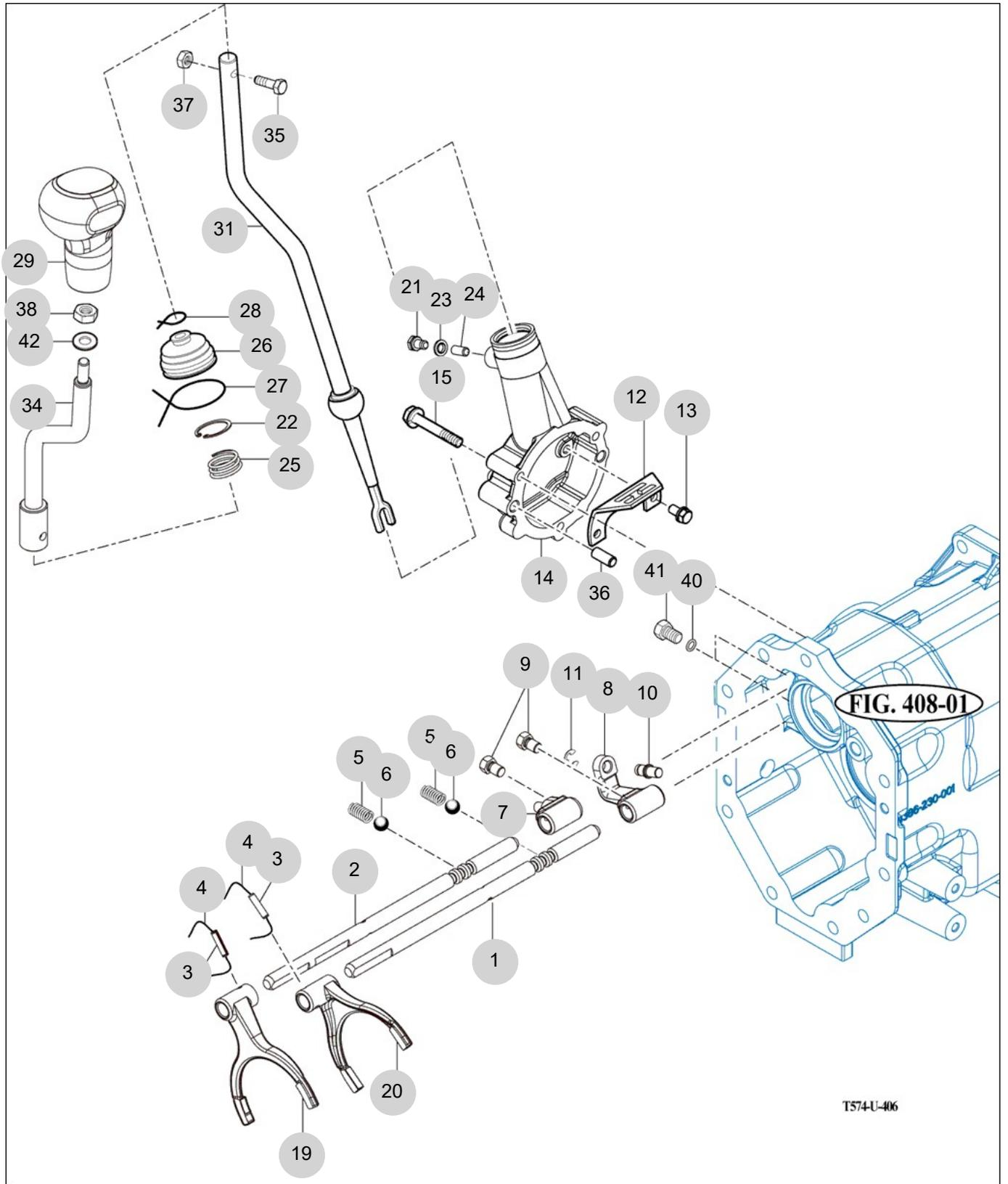

NOTE









FIG 408

T574ST-B

TRANSMISSION MID CASE

년/월  
Year/Month

2022-12

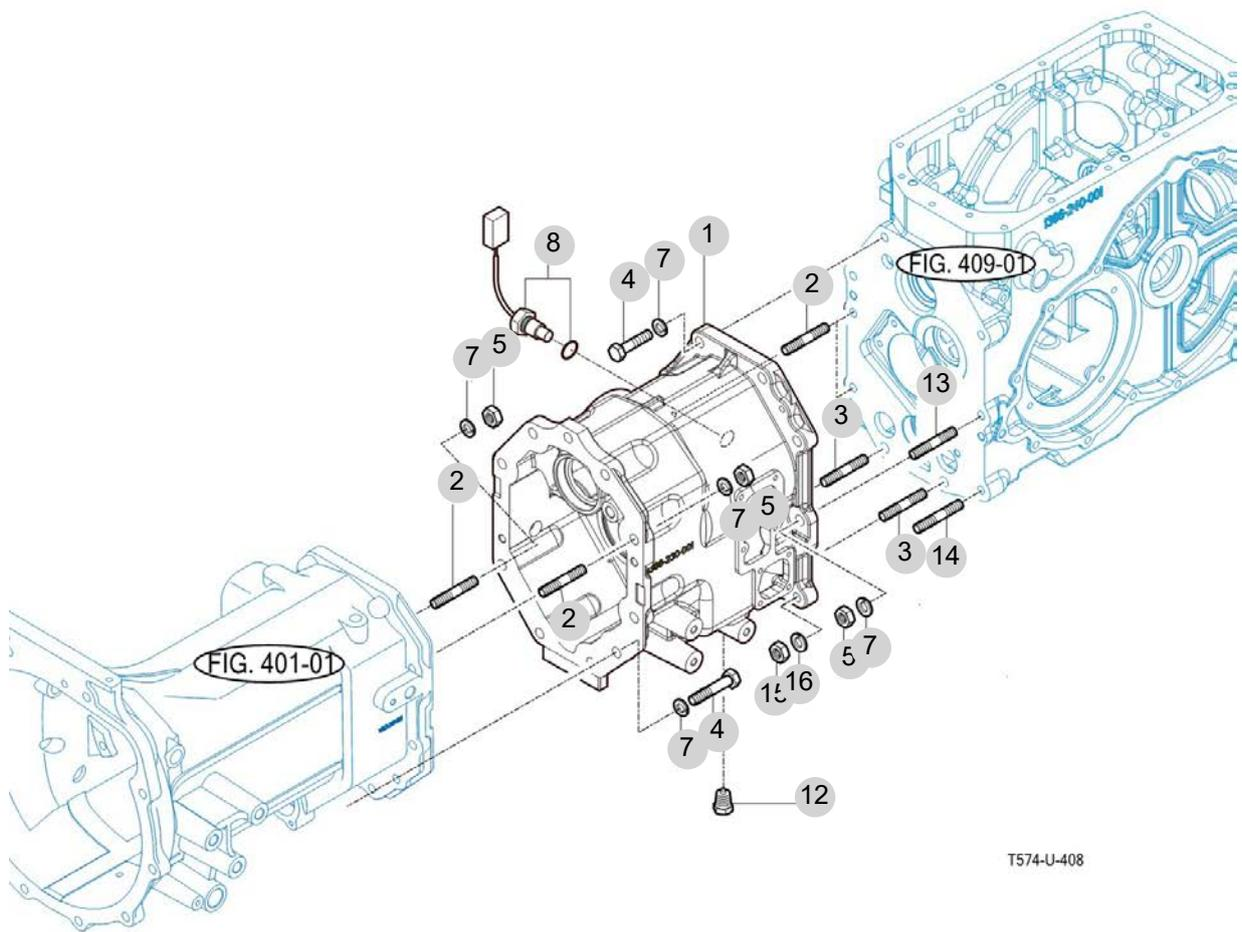

T574-U-408

NOTE



FIG 409

T574ST-B

TRANSMISSION REAR CASE

년/월  
Year/Month

2022-12

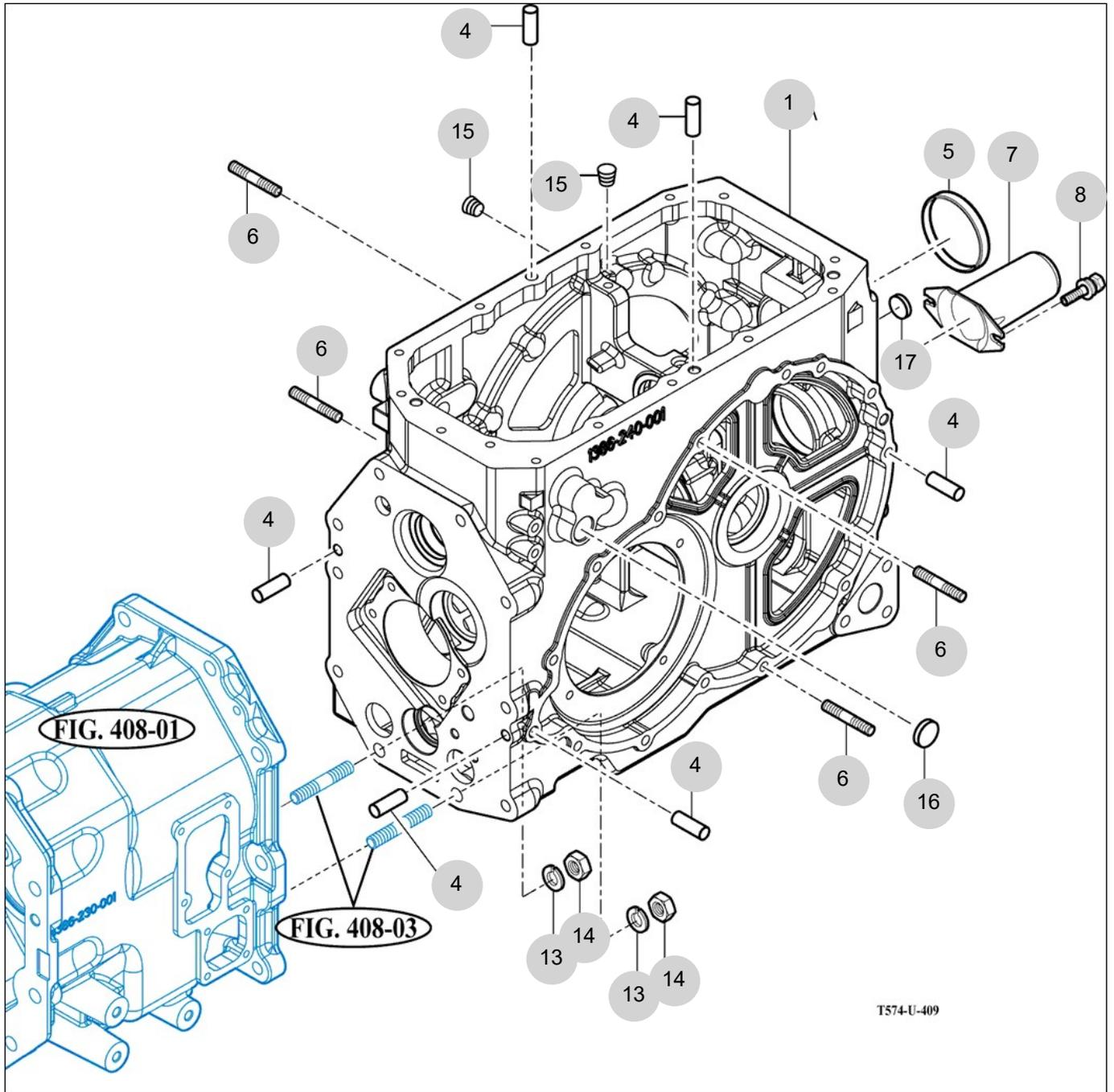

T574-U-409

NOTE



FIG 410

T574ST-B

SUB CHANGE GEARS

년/월  
Year/Month

2022-12

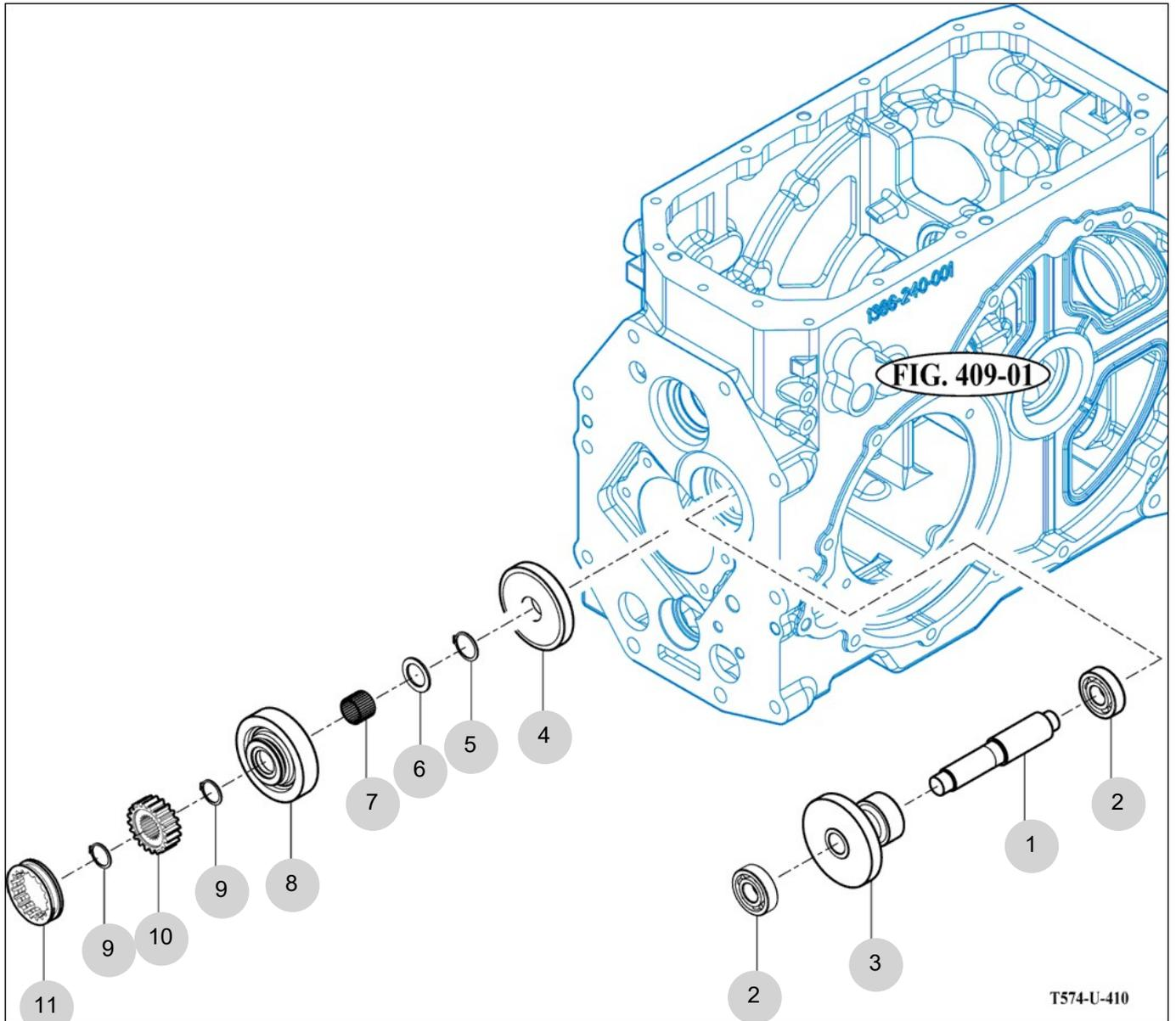

T574-U-410

NOTE





FIG 411

T574ST-B

SUB CHANGE SHIFTER

년/월  
Year/Month

2022-12

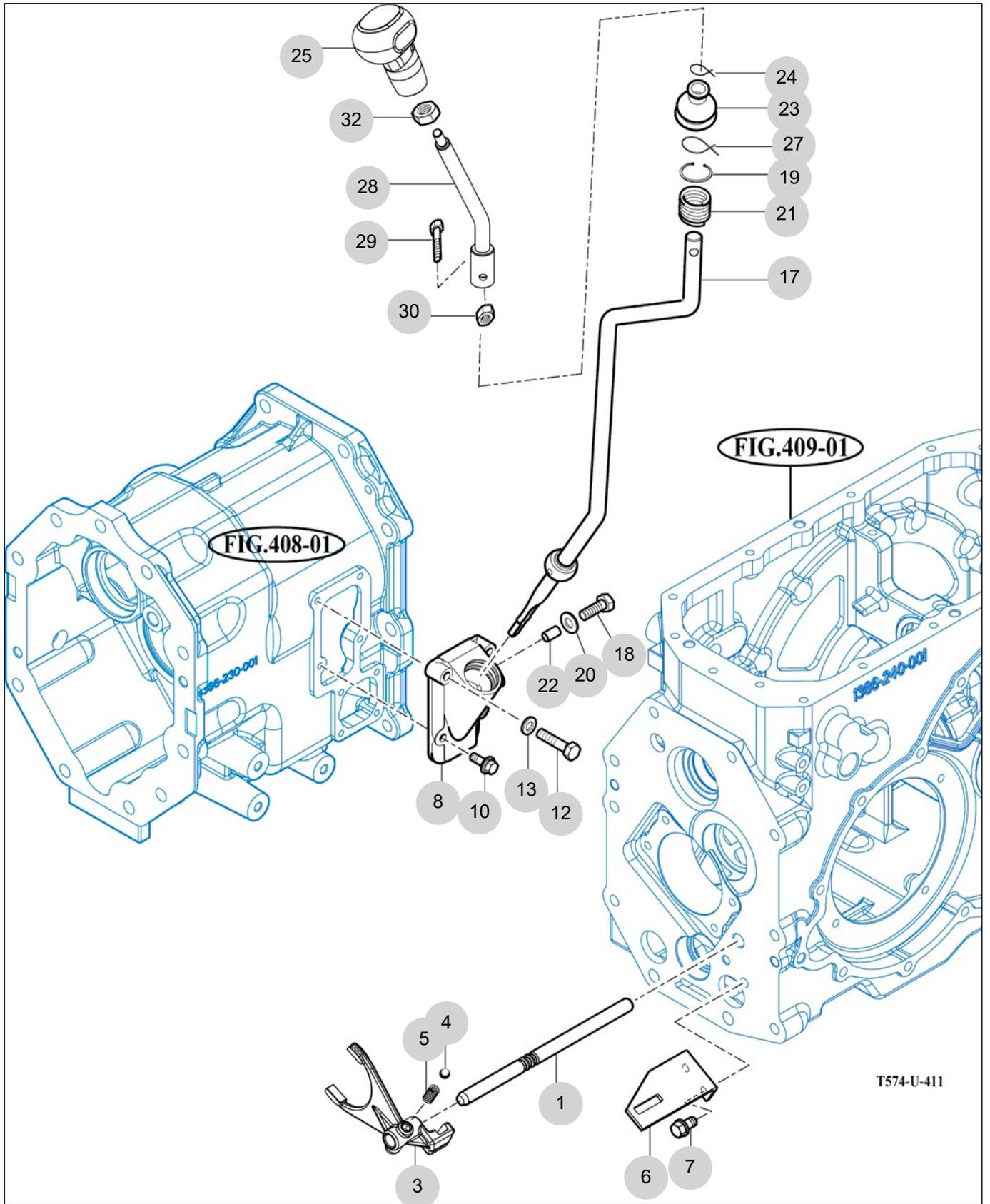

NOTE



FIG 413

DRIVE GEARS

년/월  
Year/Month

T574ST-B

2022-12

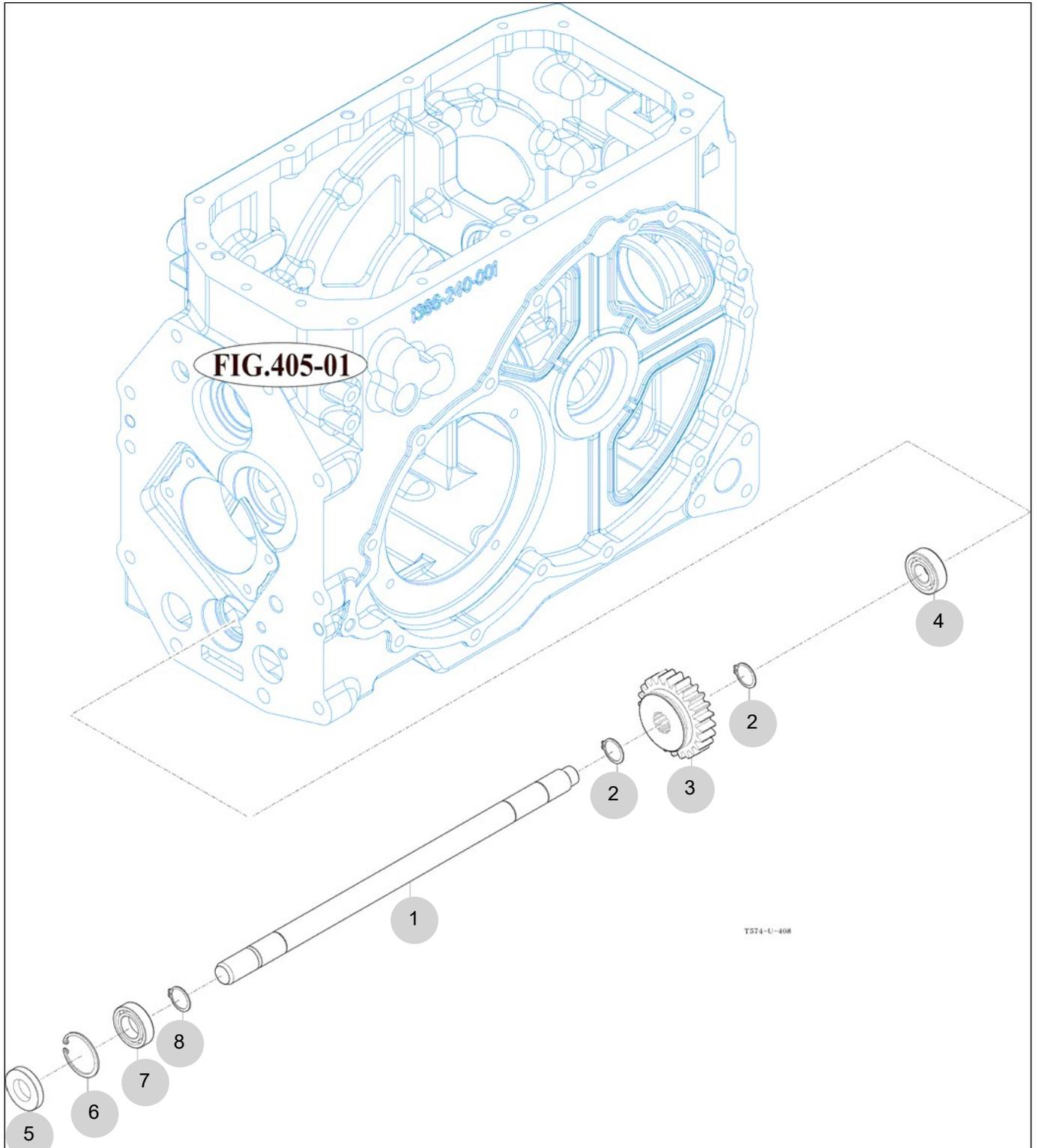

NOTE



FIG 414

4WD CHANGE LEVER

년/월  
Year/Month

T574ST-B

2022-12

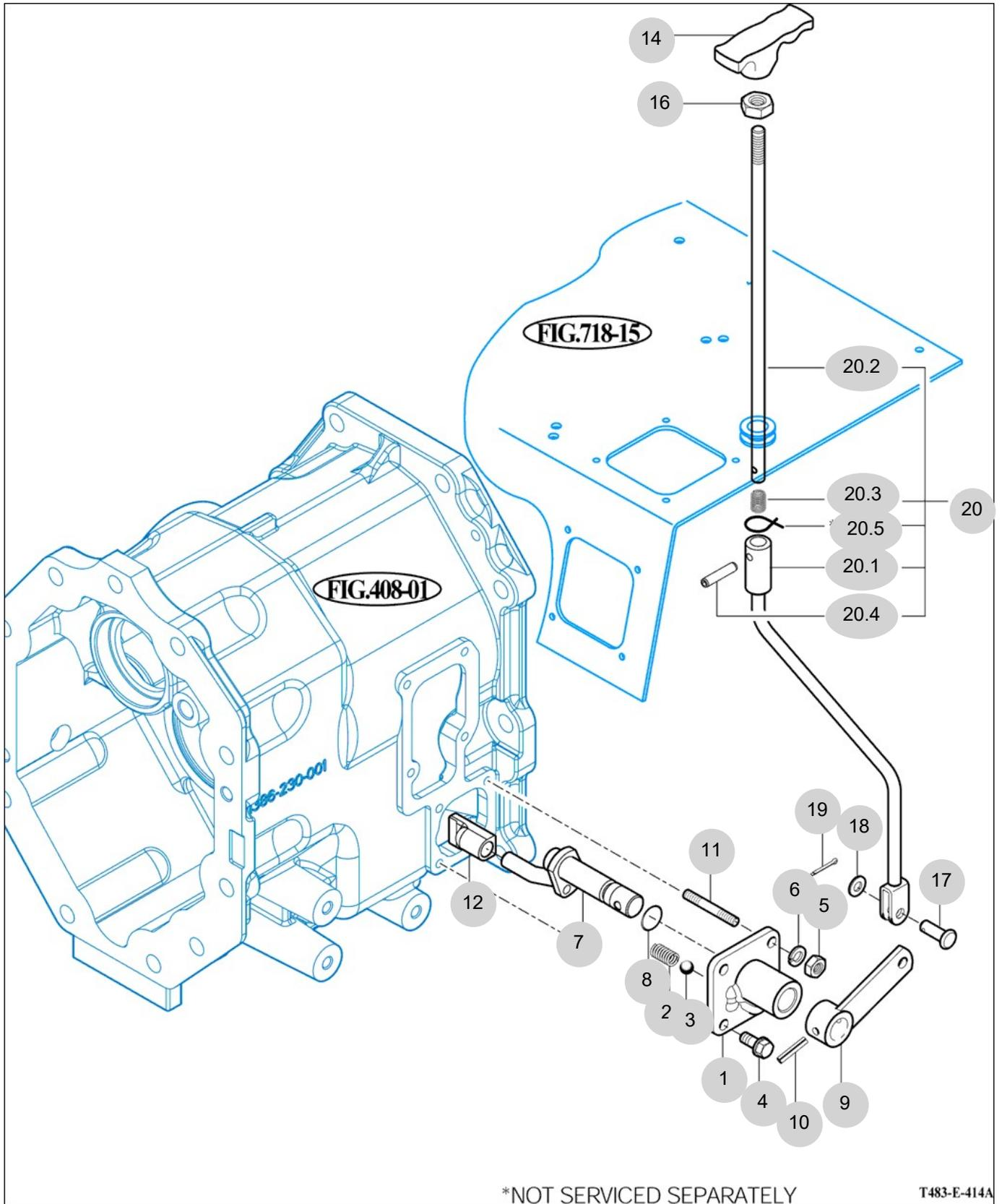

NOTE









FIG 417

REAR DIFFERENTIAL GEARS

년/월  
Year/Month

2022-12

T574ST-B

\*NOT SERVICED SEPARATELY

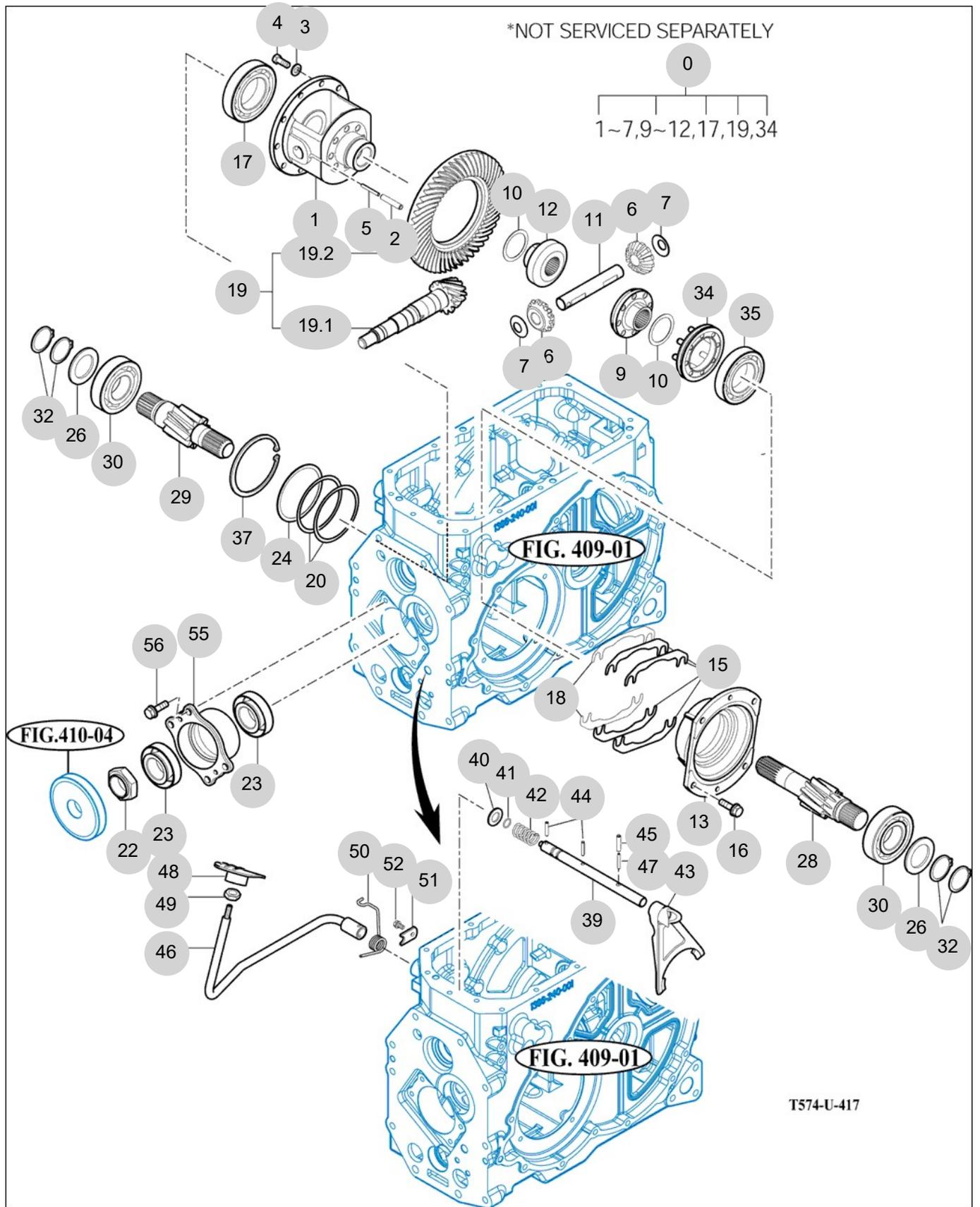

T574-U-417

NOTE

FIG 417		REAR DIFFERENTIAL GEARS					년/월 Year/Month		
							2022-12		
T574ST-B		KEY NO	PART NO	DESCRIPTION	SPEC	QTY	REPAIR	EFFECTIVE DATE	REMARKS
417	0	13863031000	DIFF ASSY, RR			1			
417	1	14523030010M	CASE , DIFF			1			
417	2	V5801408040	PIN , SPRING	8X50		1			
417	3	V4011600100	WASHER , SPRING	M10		10			
417	4	V2024610025	BOLT , HEX FINE	M10X25		10			
417	5	V5801405036	PIN , SPRING	5X36		1			
417	6	14523180041	PINION , DIFF	1X1X1		2			
417	7	14523030080	COLLAR , PINION	T=1.0		2			
417	9	14523180061	PINION , BEVEL 16T LH	1X1X1		1			
417	10	14523030100	WASHER , THRUST	D=52.5		2			
417	11	14523030110	SHAFT , DIFF PINION	D=23		1			
417	12	14523180031	PINION , BEVEL 16T RH	1X1X1		1			
417	13	14523030131M	METAL , DIFF CASE LH			1			
417	15	14523010090	SHIM , B	T=0.2		4			
417	16	V2173610025	BOLT , HEX/S	M10X25		4			
417	17	V6001106212	BEARING , BALL	6212		1			
417	18	14523010080	SHIM , A	T=0.1		2			
417	19	13863022100	GEAR SET , 10-41T			1			
417	19.1	13863022110	PINION, BEVEL			1			
417	19.2	14523022120	GEAR , SPIRAL BEVEL			1			
417	20	14523010050	SHIM , 0.1	T=0.1		2			
417	22	15533030020	NUT , M40 P1,5	육각B=55		1			
417	23	V6321132208	BEARING , TAPER-ROLLER	32208CR		2			
417	24	14523010100	SHIM , 0.2	T=0.2		1			
417	26	15133060030	COLLAR , THRUST 45X68X4			2			
417	28	14523060010	PINION , LH HERICAL11T			1			
417	28	14523060011	PINION , LH HERICAL11T			1			
417	29	14523060020	PINION , RH HERICAL11T			1			
417	29	14523060021	PINION , RH HERICAL11T			1			
417	30	V6001106309	BEARING , BALL	6309		2			
417	30	V6041106309	BEARING , BALL/HL1			1			
417	32	V7041400450	C-RING , SHAFT	45		4			
417	34	14523033400	SLEEVE COMP			1			
417	35	V6001106211	BEARING , BALL	6211		1			
417	37	V7051401100	C-RING , HOLE	110		1			
417	39	14523032002	SHAFT , DIFF LOCK	D=20		1			
417	40	V4111600200	WASHER , PLAIN	M20		1			
417	41	V7201024016	O-RING , P	P16		1			
417	42	17973030420	SPRING	(D=3.6) X22.5X74.5		1			
417	43	14523190011M	FORK , DIFF LOCK			1			
417	44	V5801406032	PIN , SPRING	6X32		2			
417	45	V5801408036	PIN , SPRING	8X36		1			
417	46	14543162101	PEDAL COMP , DIFF LOCK			1			
417	47	V5801405036	PIN , SPRING	5X36		1			
417	48	14521220120	PEDAL COMP,ACCEL	1X1X1		1			
NOTE									



FIG 418

REAR AXLE HOUSING

년/월  
Year/Month

T574ST-B

2022-12

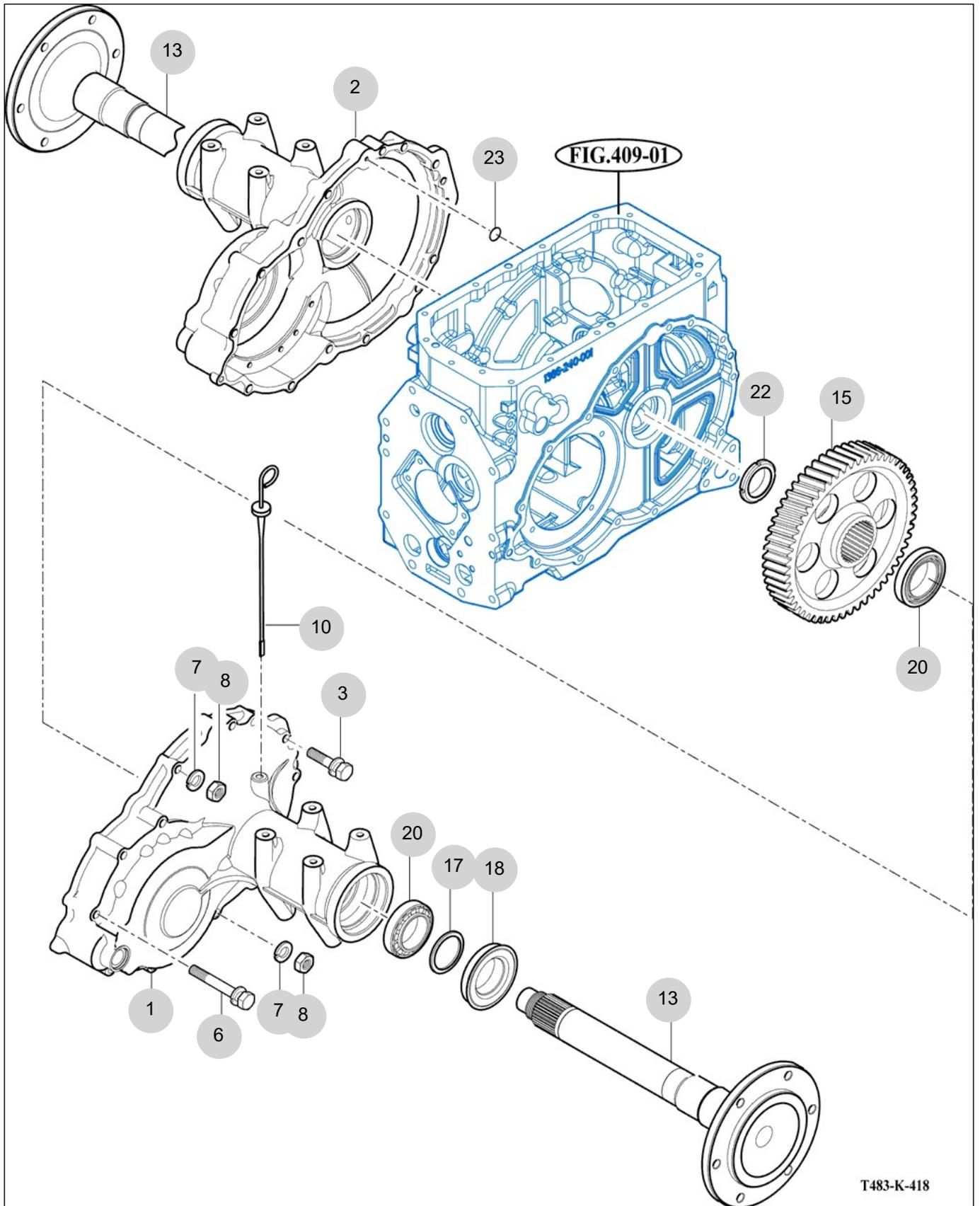

T483-K-418

NOTE



## 5. Front Axle PART NO. T5

FIG 501 FRONT AXLE SUPPORT	176
FIG 502 FRONT DRIVE SHAFT	178
FIG 503 FRONT AXLE HOUSING	180
FIG 504 FRONT DIFFERENTIAL GEARS	182
FIG 505 FRONT GEAR CASE (1)	184
FIG 506 FRONT GEAR CASE (2)	186
FIG 507 FRONT GEAR CASE (3)	188

FIG 501

T574ST-B

FRONT AXLE SUPPORT

년/월  
Year/Month

2022-12

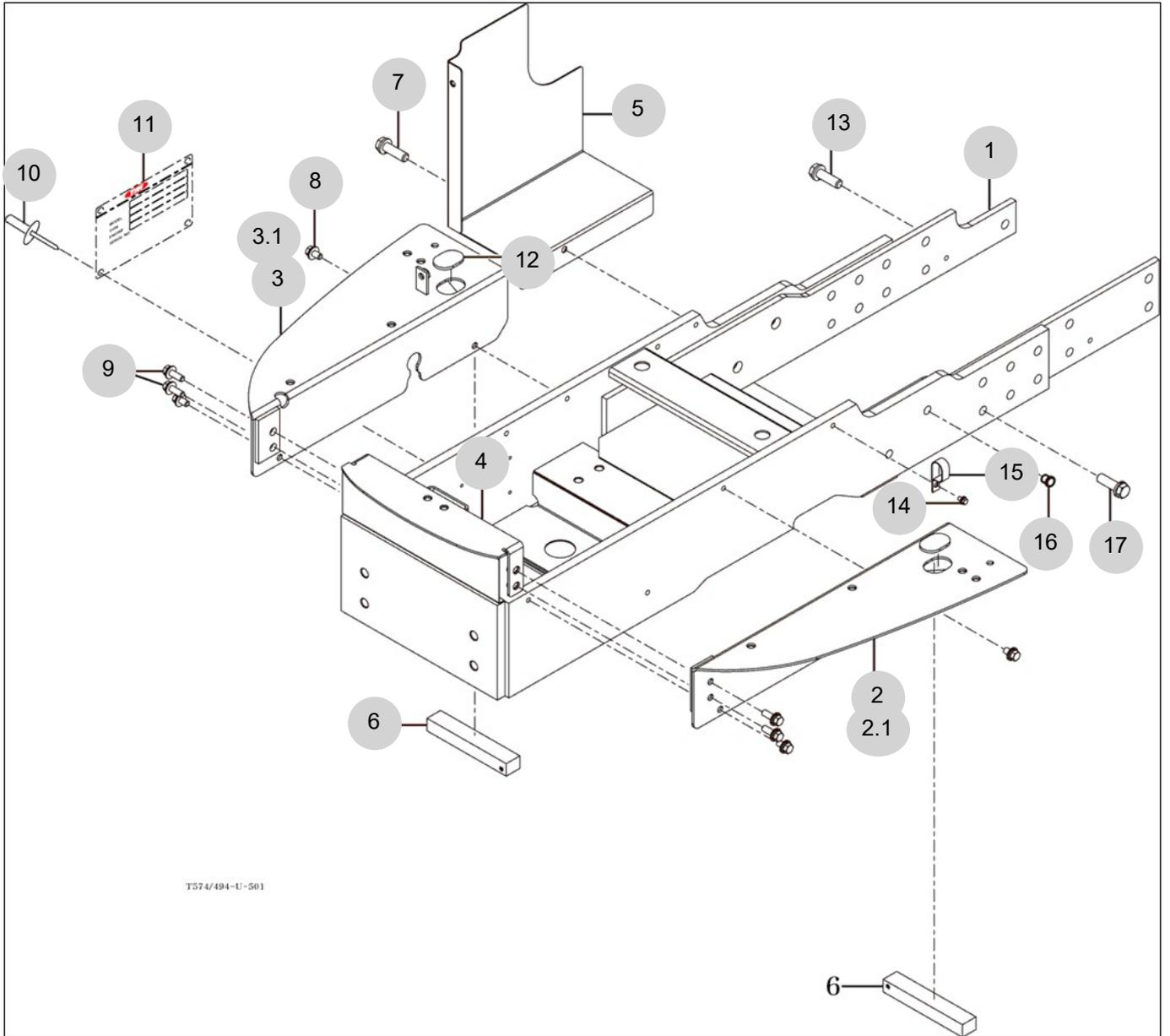

NOTE





FIG 502

FRONT DRIVE SHAFT

년/월  
Year/Month

T574ST-B

2022-12

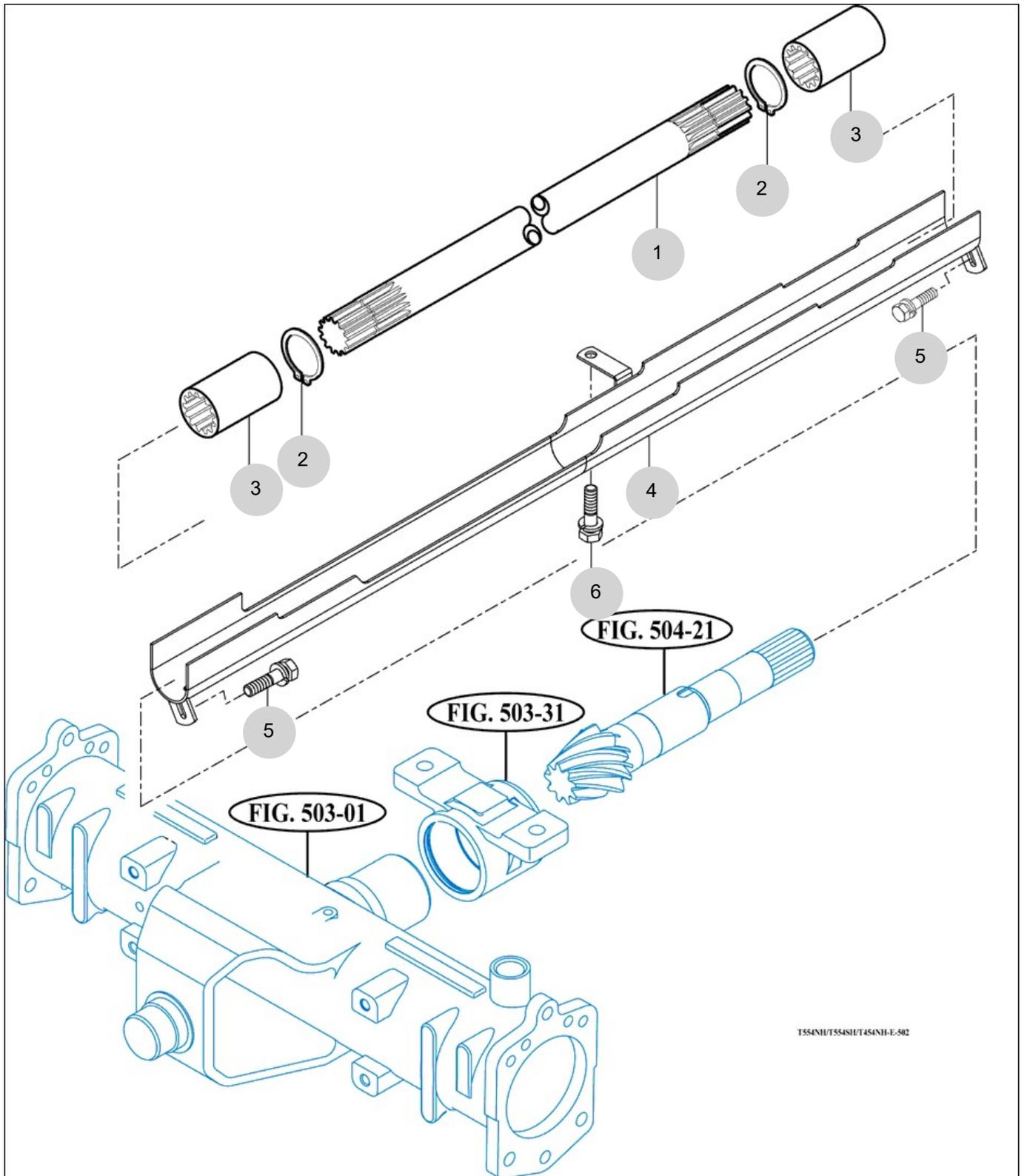

T554NH/T554SH/T454NH-E-502

NOTE



FIG 503

T574ST-B

FRONT AXLE HOUSING

년/월  
Year/Month

2022-12

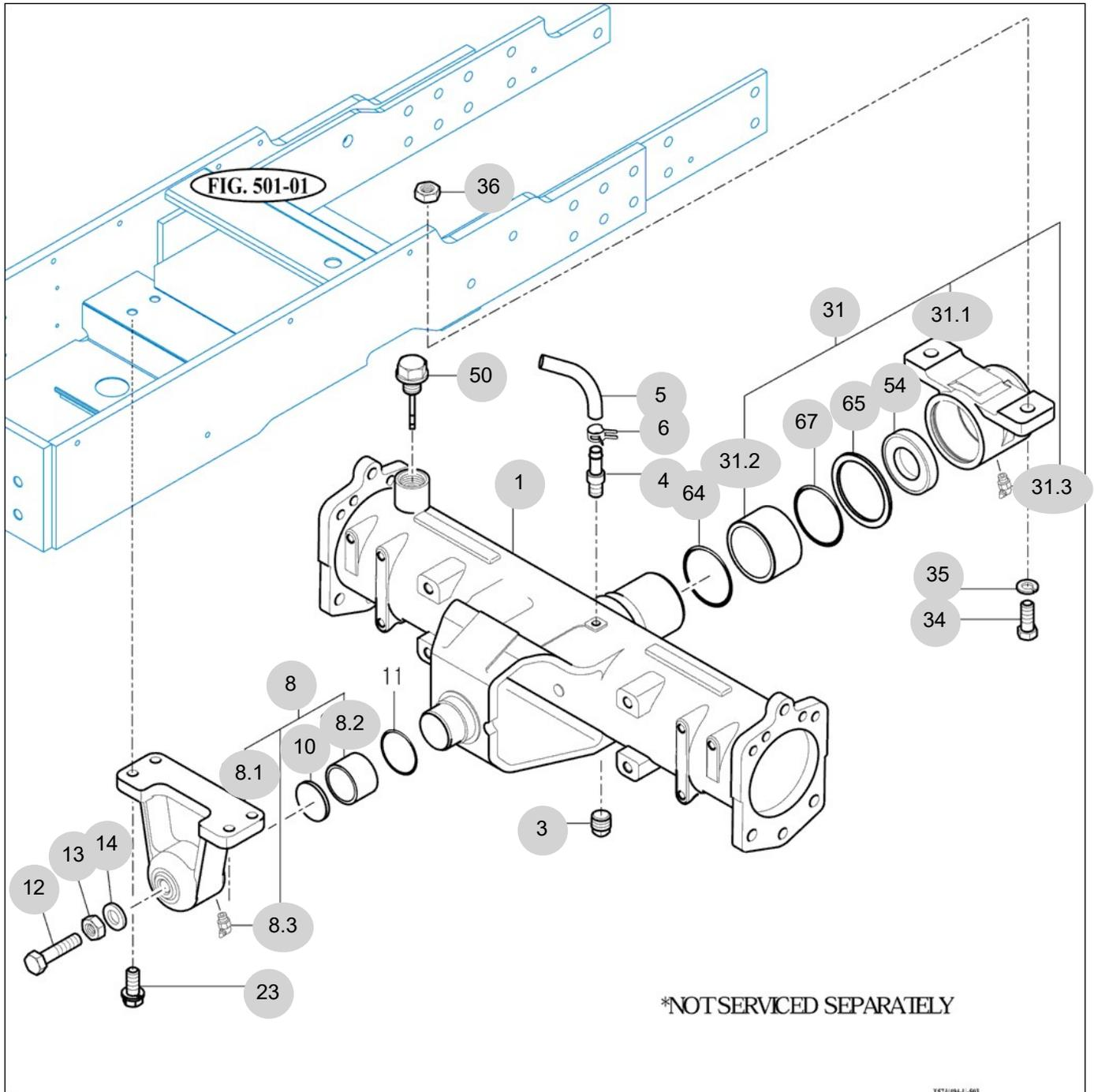

NOTE



FIG 504

FRONT DIFFERENTIAL GEARS

년/월  
Year/Month

2022-12

T574ST-B

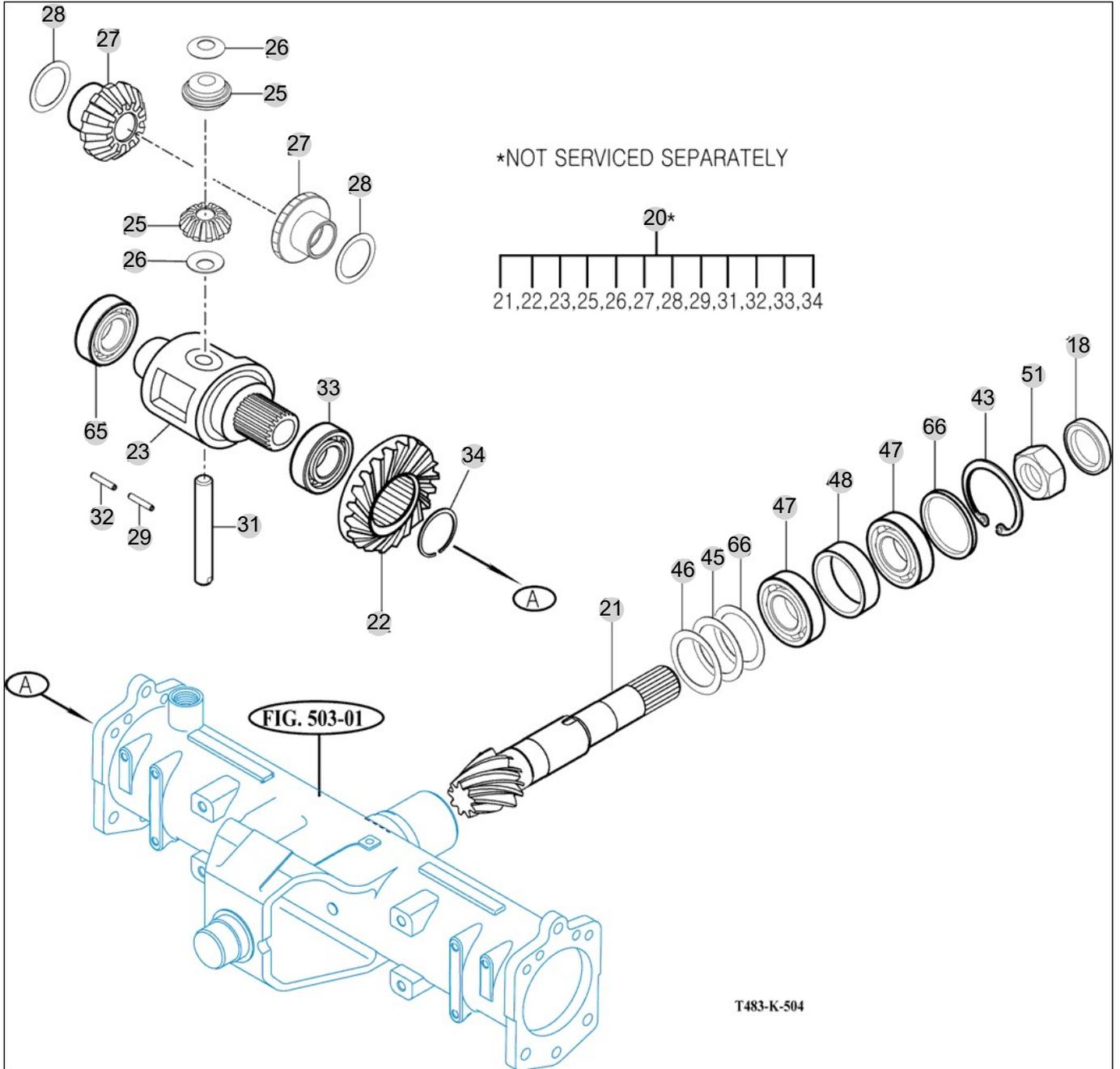

NOTE



FIG 505

T574ST-B

FRONT GEAR CASE (1)

년/월  
Year/Month

2022-12

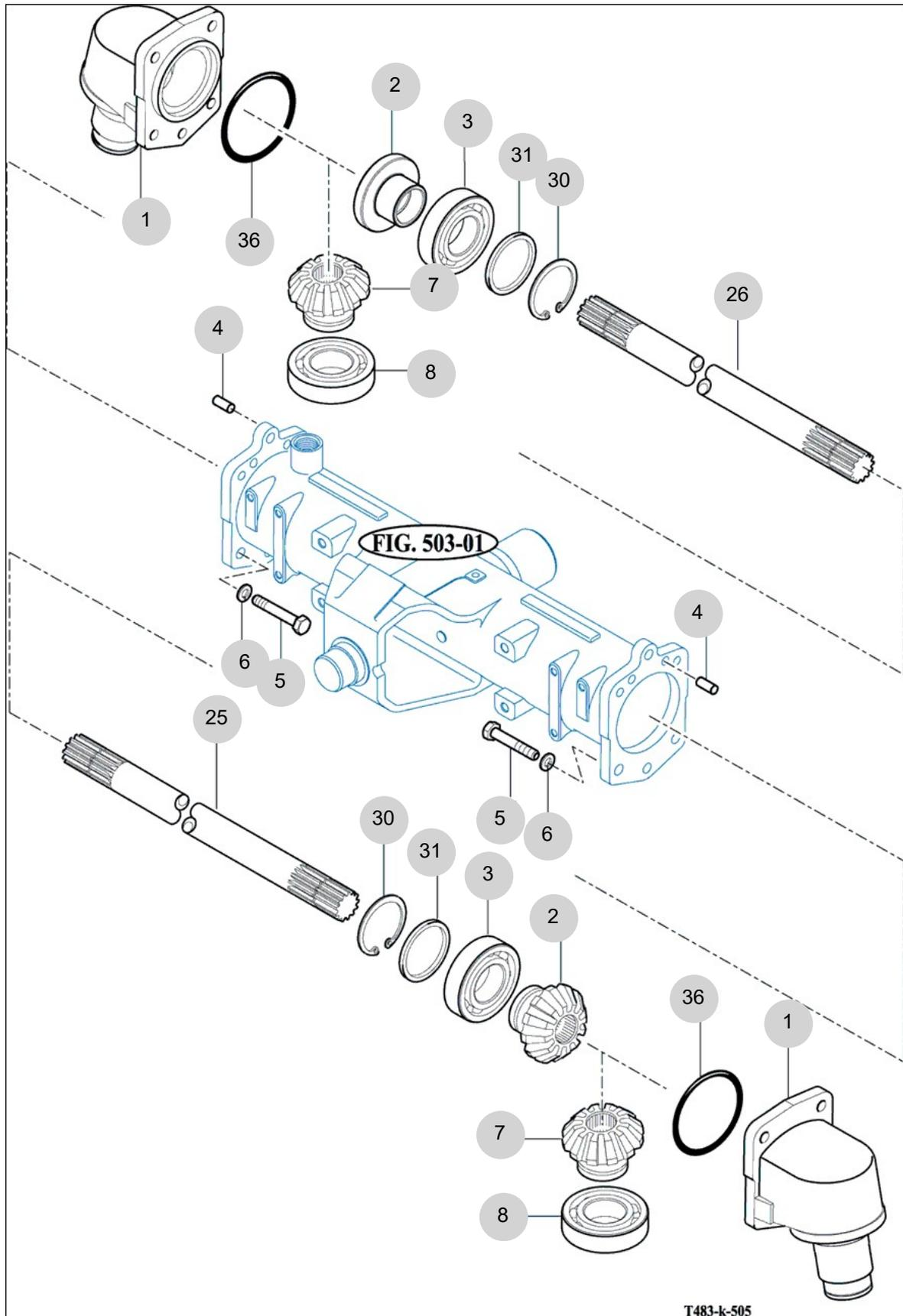

T483-k-505

NOTE





FIG 506

FRONT GEAR CASE (2)

년/월  
Year/Month

2022-12

T574ST-B

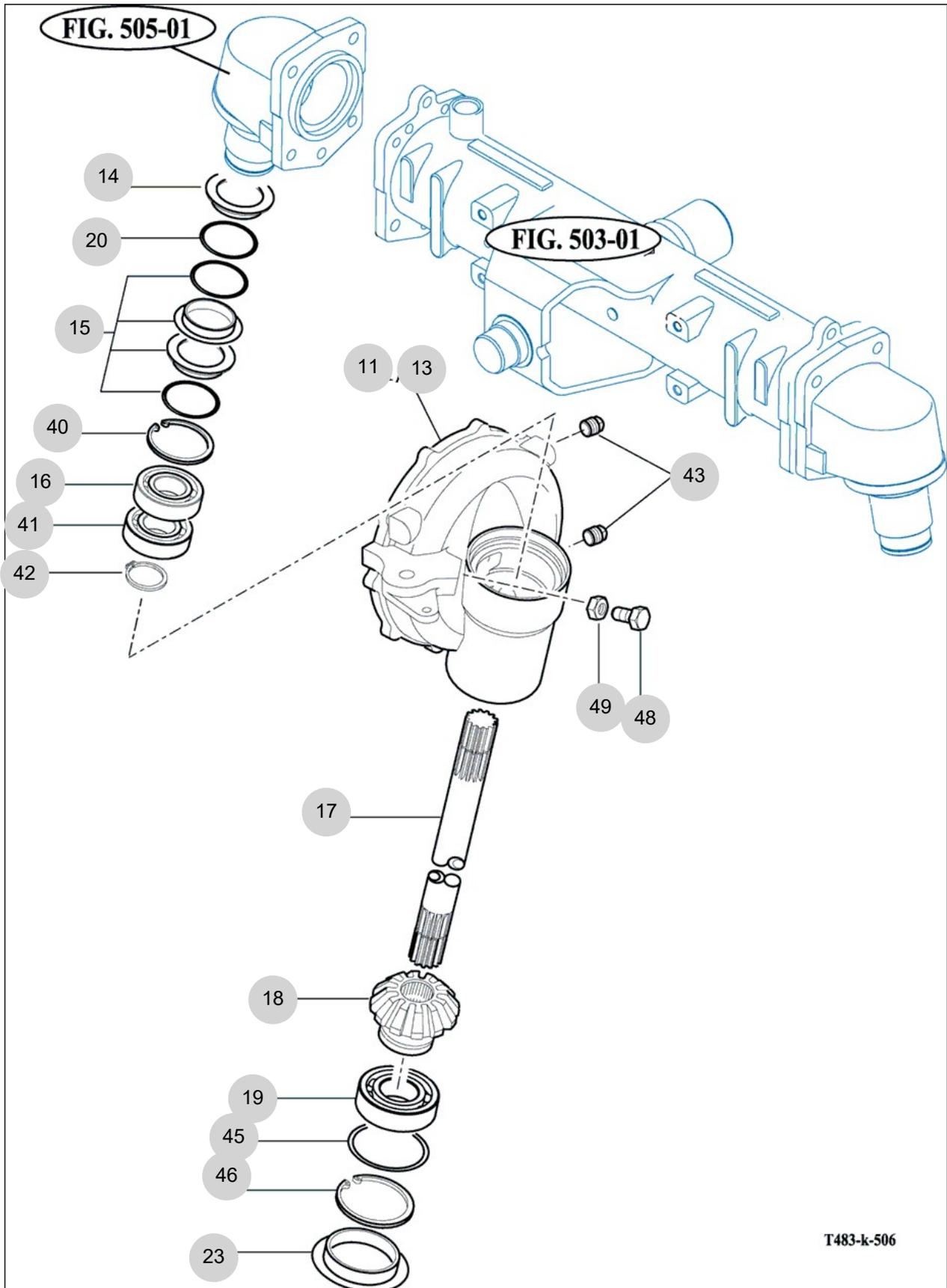

T483-k-506

NOTE



FIG 507

FRONT GEAR CASE (3)

년/월  
Year/Month

T574ST-B

2022-12

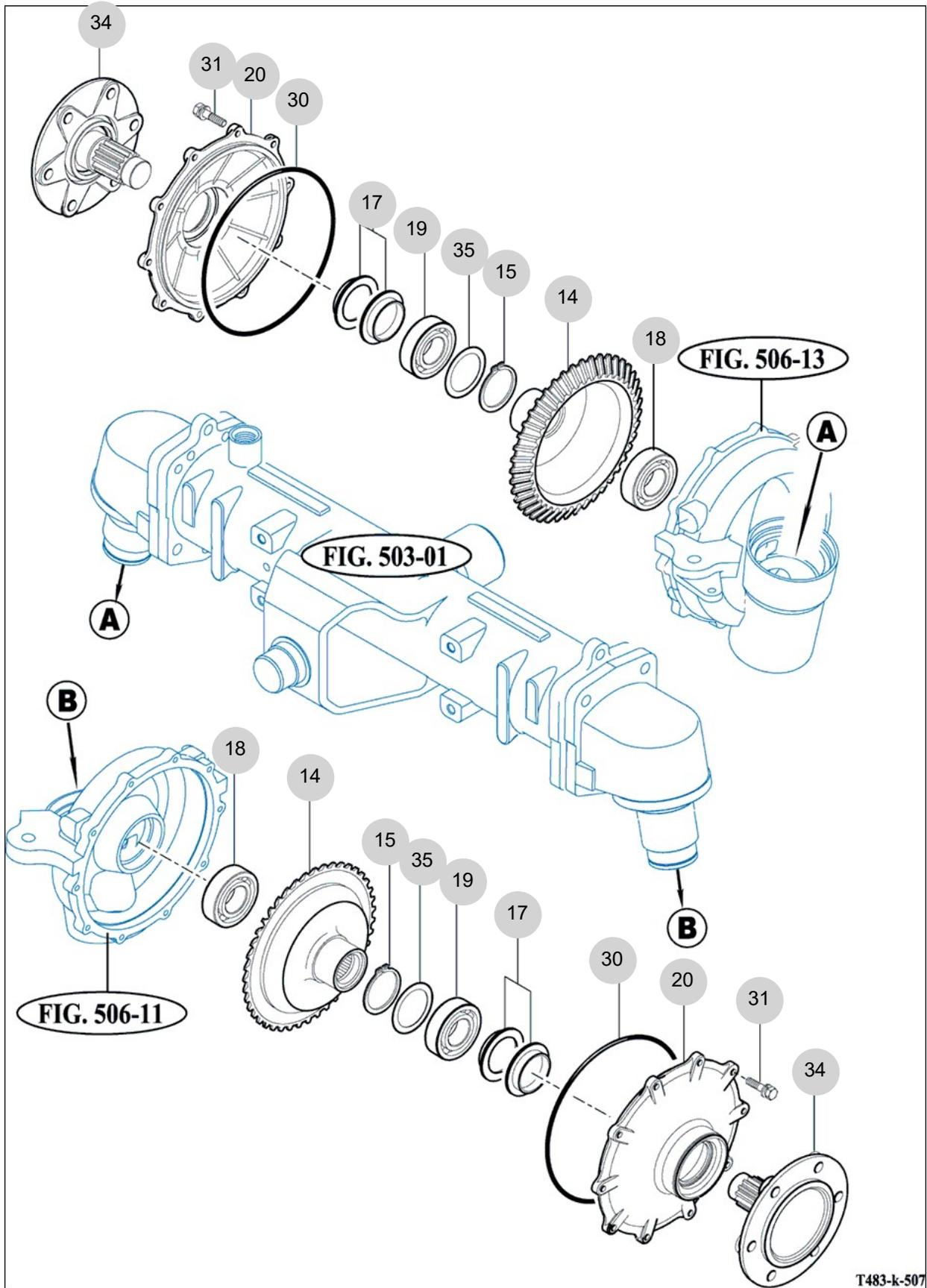

T483-k-507

NOTE



## 6. Hydraulic/3P-Link PART NO. T6

FIG 601 CYLINDER CASE	191
FIG 602 LIFT ARM	193
FIG 603 CYLINDER	195
FIG 604 POSITION LINK	197
FIG 605 CONTROL VALVE	199
FIG 606 DRAFT LINK	201
FIG 607A POSITION & DRAFT LEVER (1)	203
FIG 607B POSITION & DRAFT LEVER (2)	205
FIG 608 EXTERIOR HYD. VALVE	207
FIG 609 HYDRAULIC PIPE	209
FIG 610 JOYSTICK[SAP 가져오기]에서 생성함.	211
FIG 610 JOYSTICK	213
FIG 612 HITCH & 3-POINT LINK	215
FIG 613 LOWER LINK & LIFT ROD	218

FIG 601

T574ST-B

CYLINDER CASE

년/월  
Year/Month

2022-12

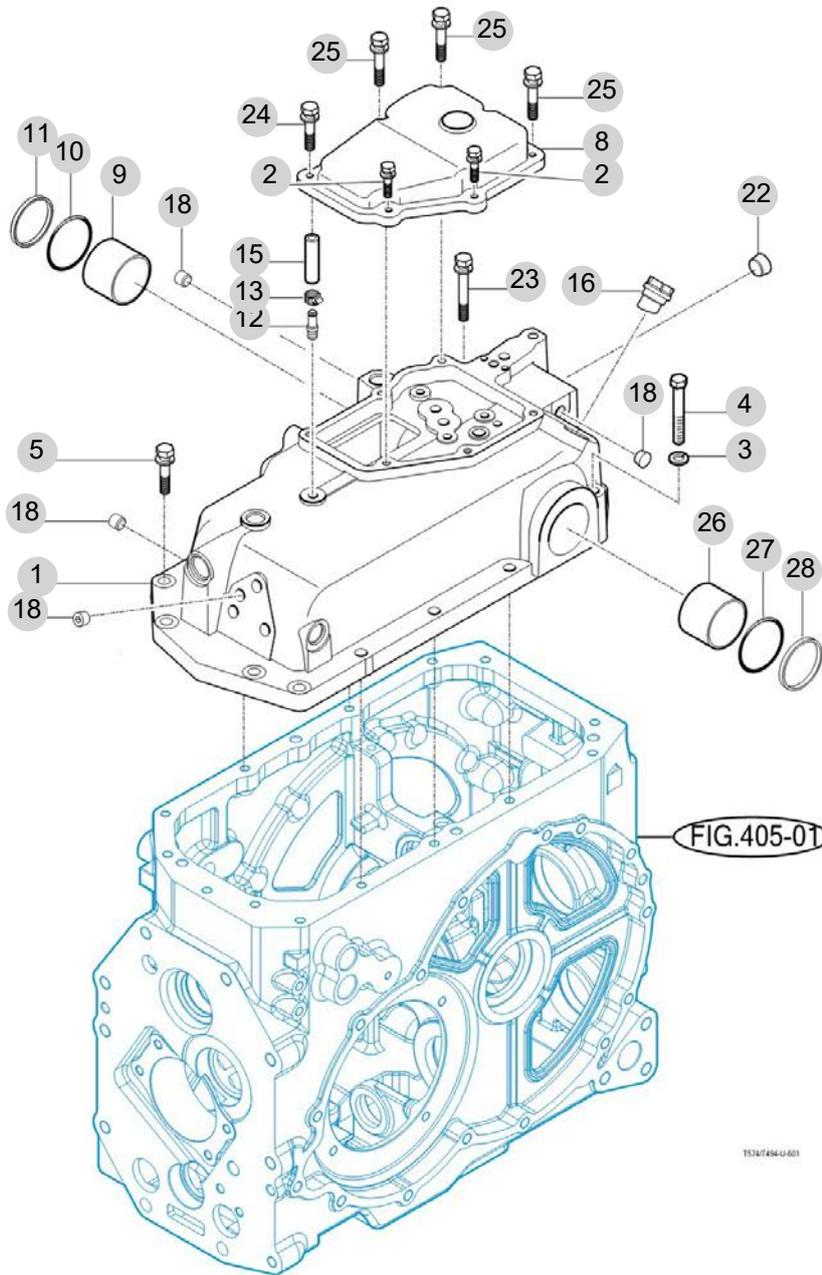

T574T406U-001

NOTE





FIG 602

T574ST-B

LIFT ARM

년/월  
Year/Month

2022-12

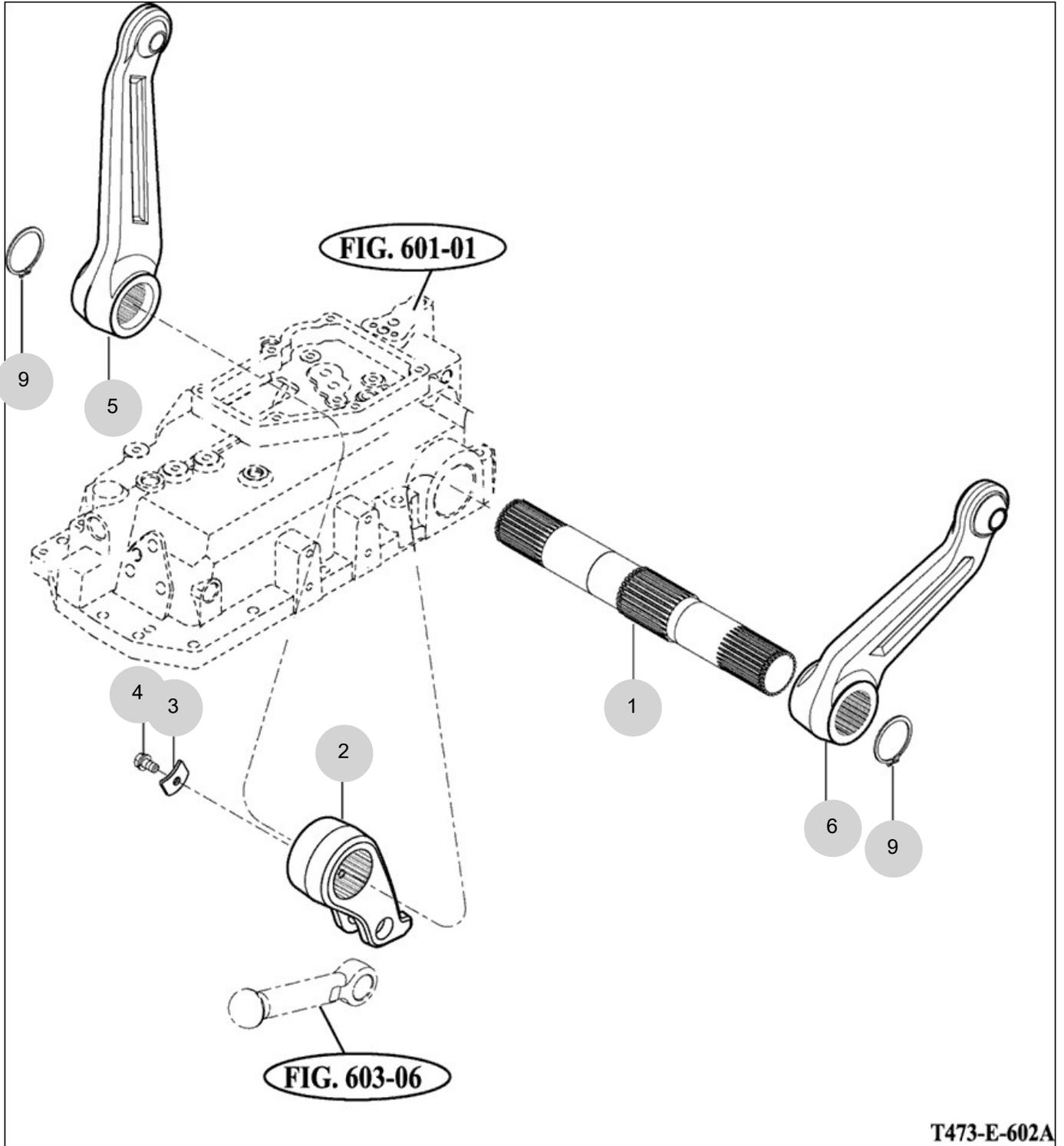

NOTE



FIG 603

T574ST-B

CYLINDER

년/월  
Year/Month

2022-12

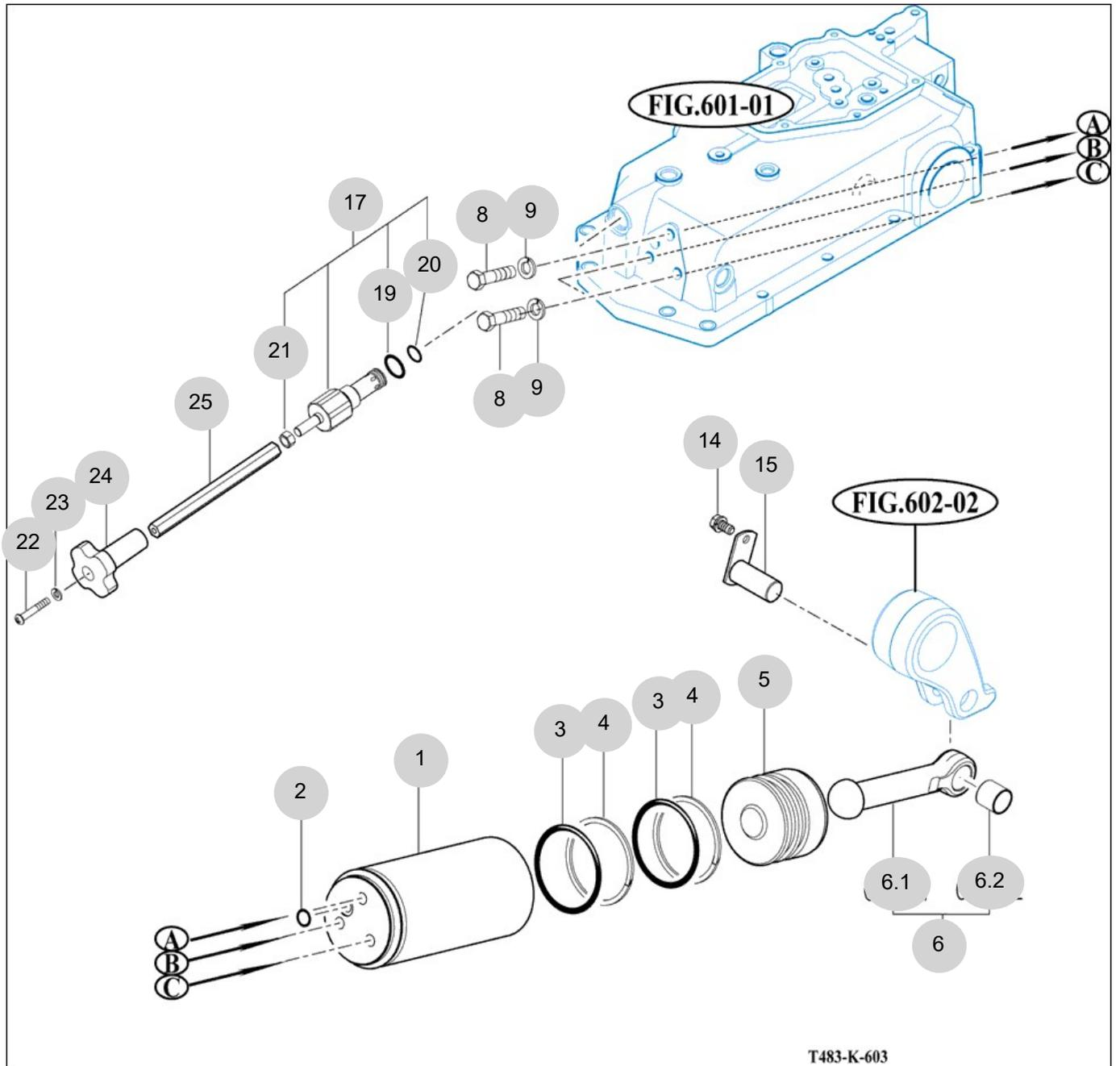

T483-K-603

NOTE



FIG 604

POSITION LINK

년/월  
Year/Month

T574ST-B

2022-12

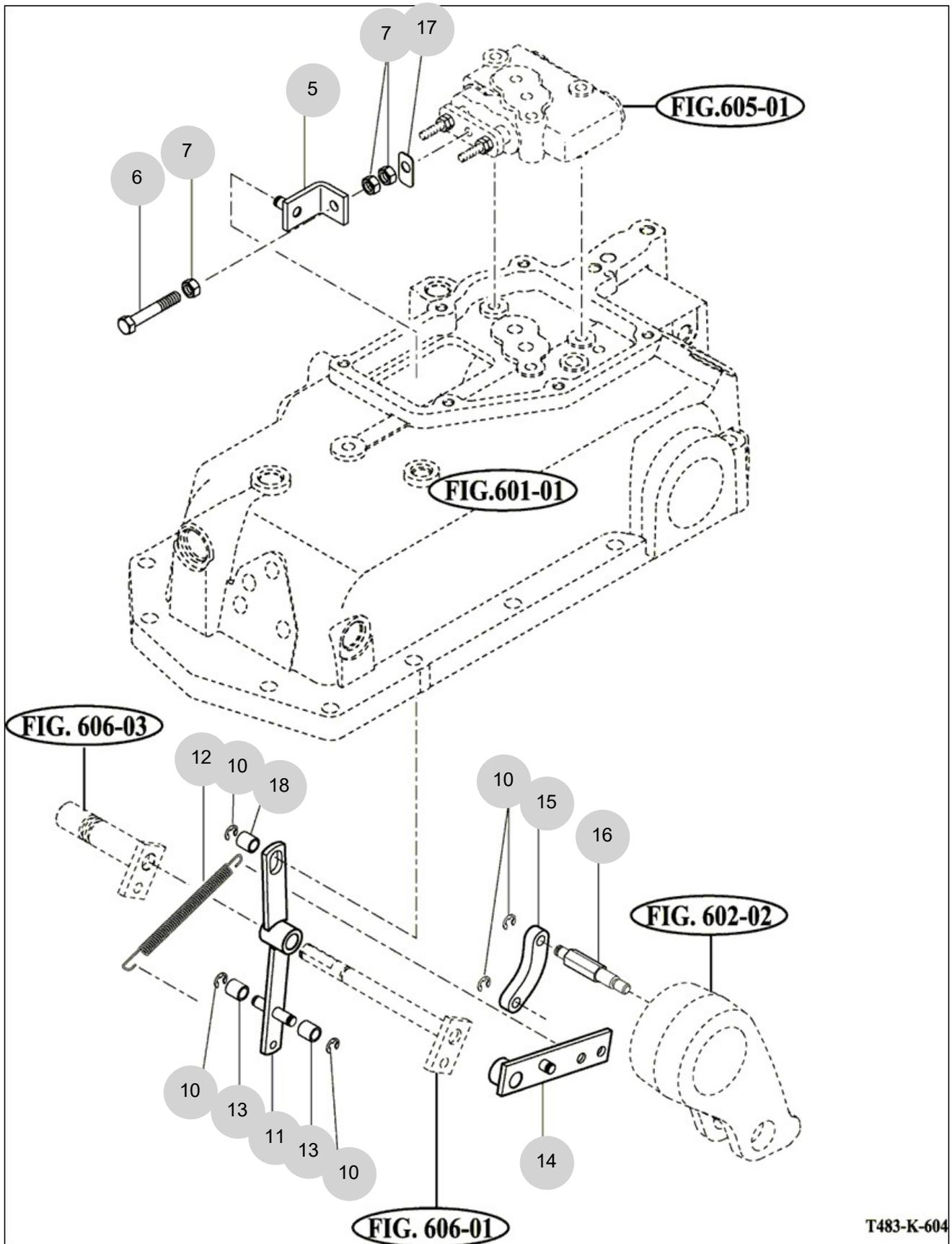

T483-K-604

NOTE



FIG 605

T574ST-B

CONTROL VALVE

년/월  
Year/Month

2022-12

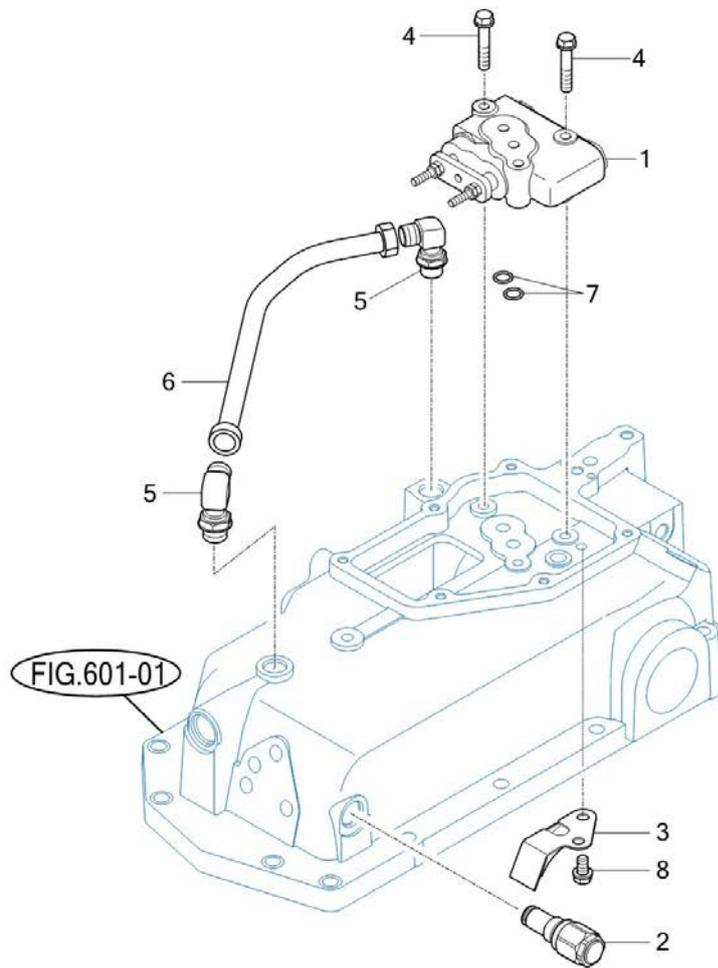

T574-U-605

NOTE





FIG 606

T574ST-B

DRAFT LINK

년/월  
Year/Month

2022-12

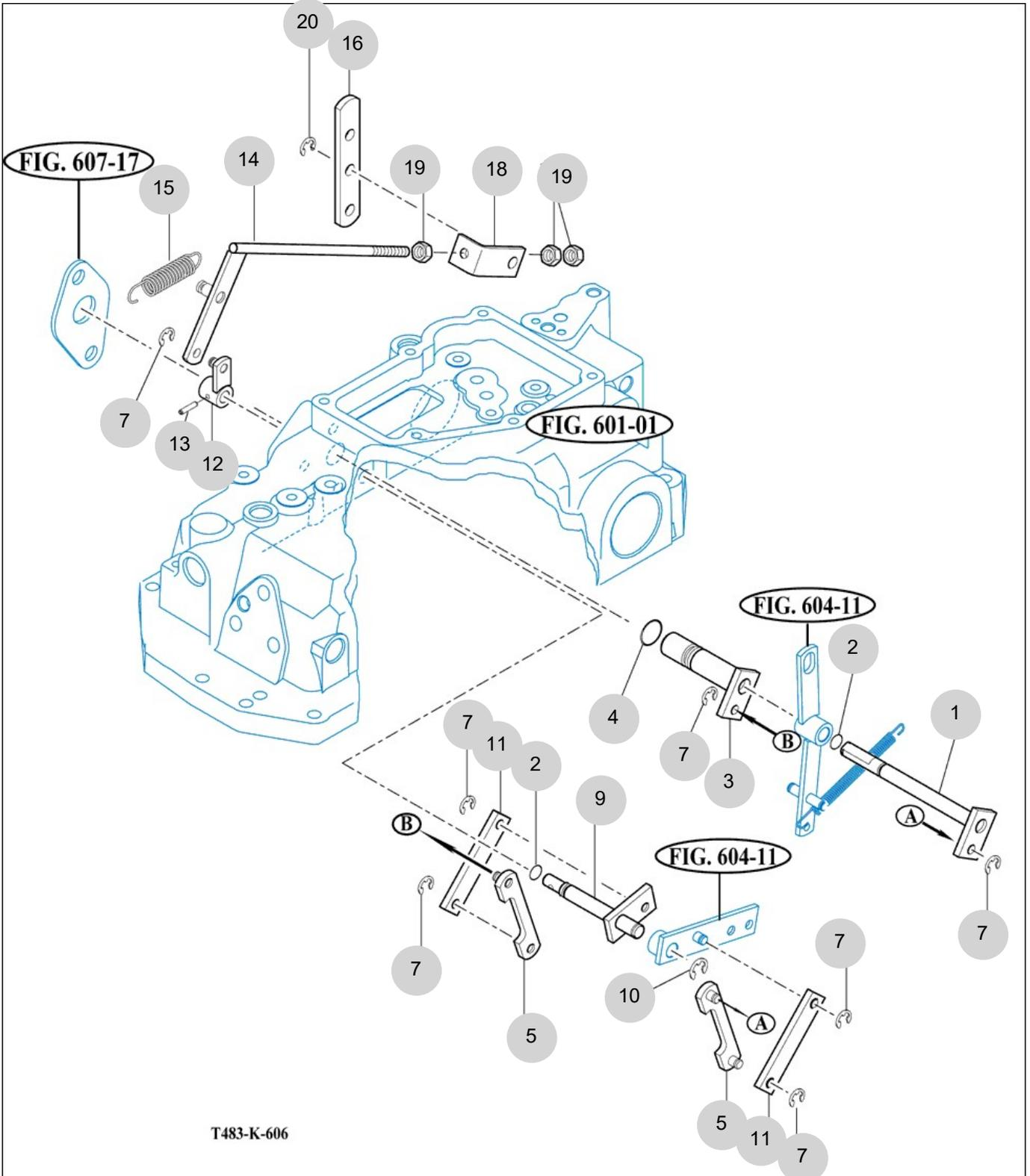

NOTE





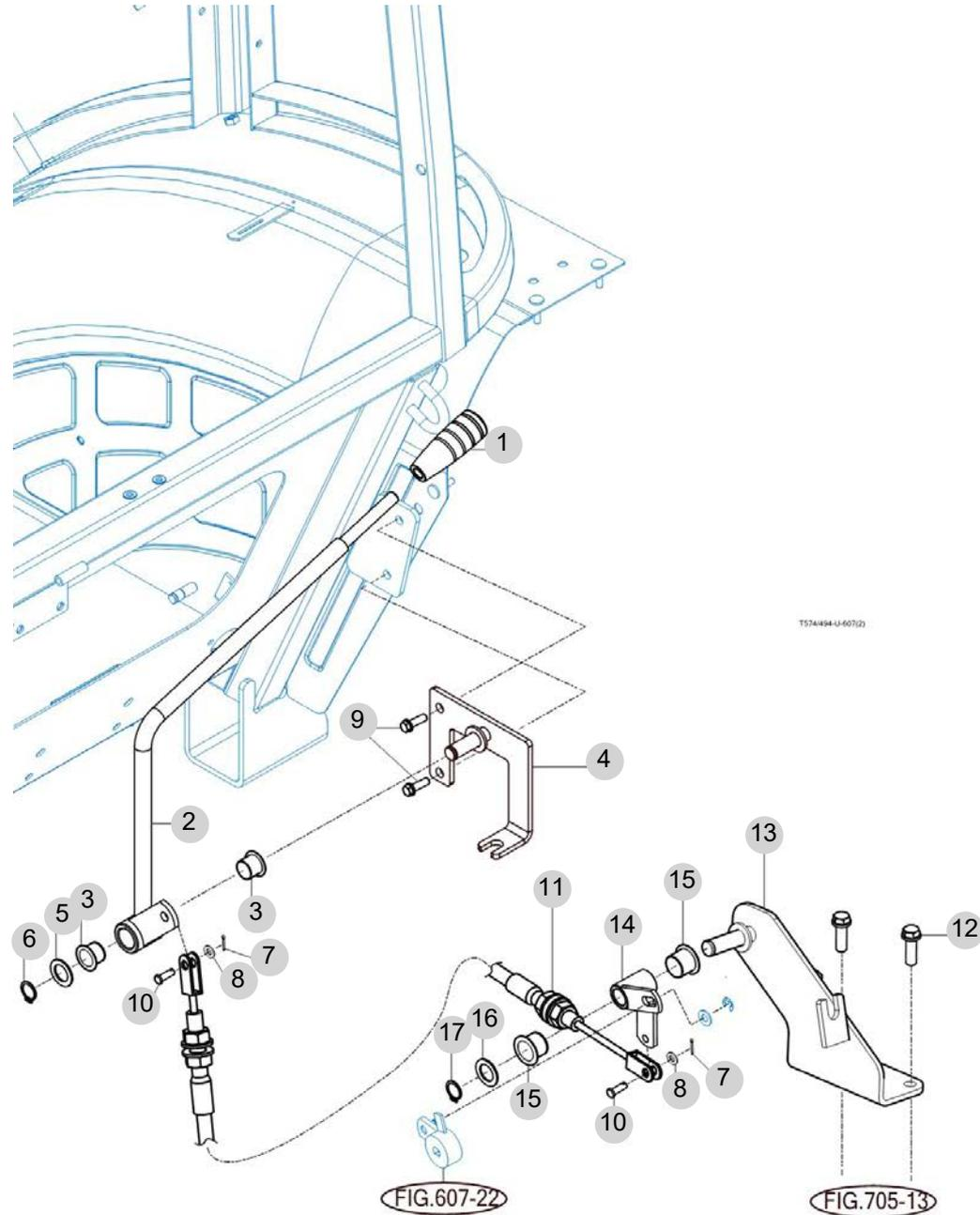

FIG 607B

POSITION & DRAFT LEVER (2)

년/월  
Year/Month

2022-12



NOTE



FIG 608

EXTERIOR HYD. VALVE

년/월  
Year/Month

2022-12

T574ST-B

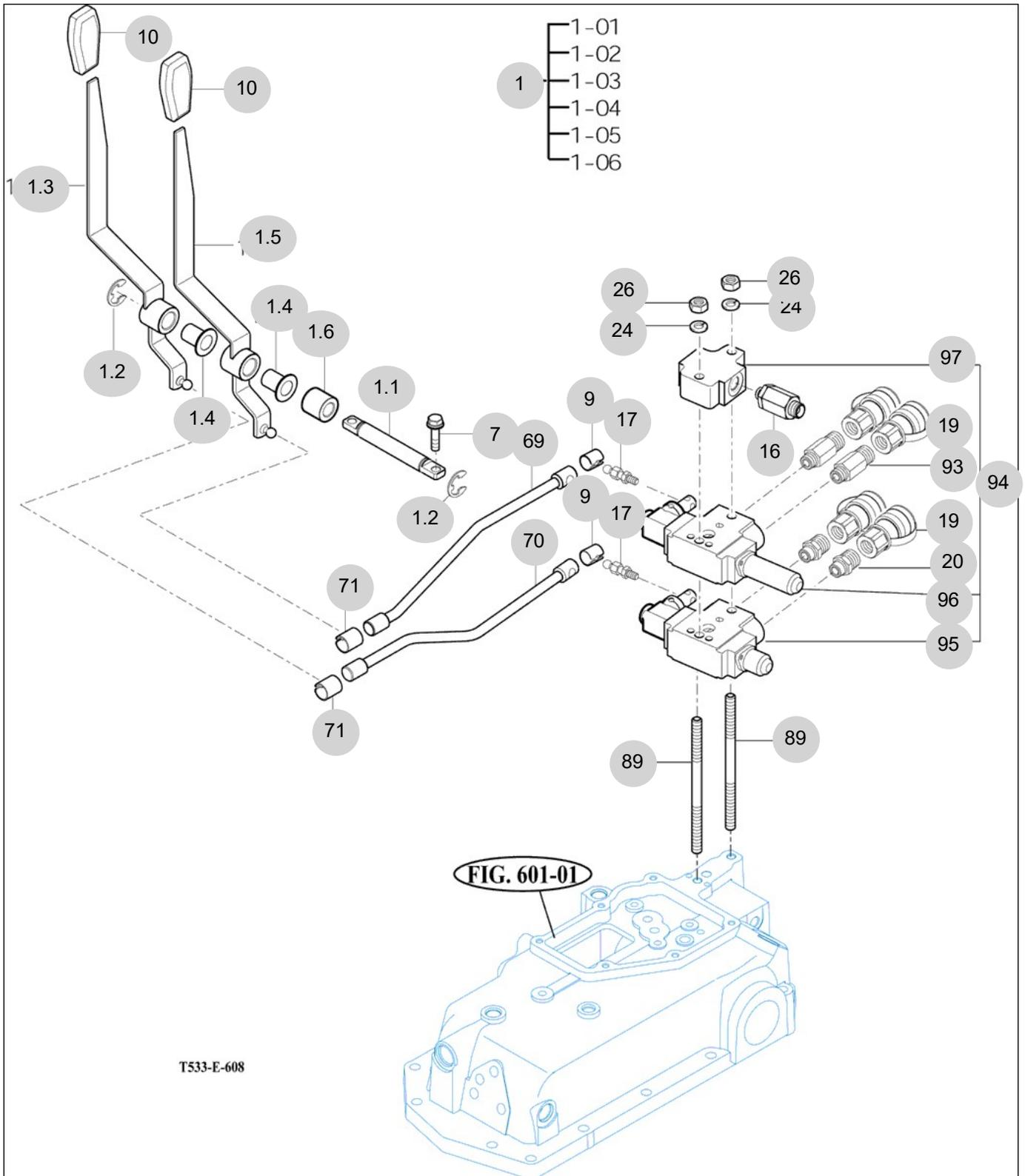

NOTE





FIG 609

HYDRAULIC PIPE

년/월  
Year/Month

T574ST-B

2022-12

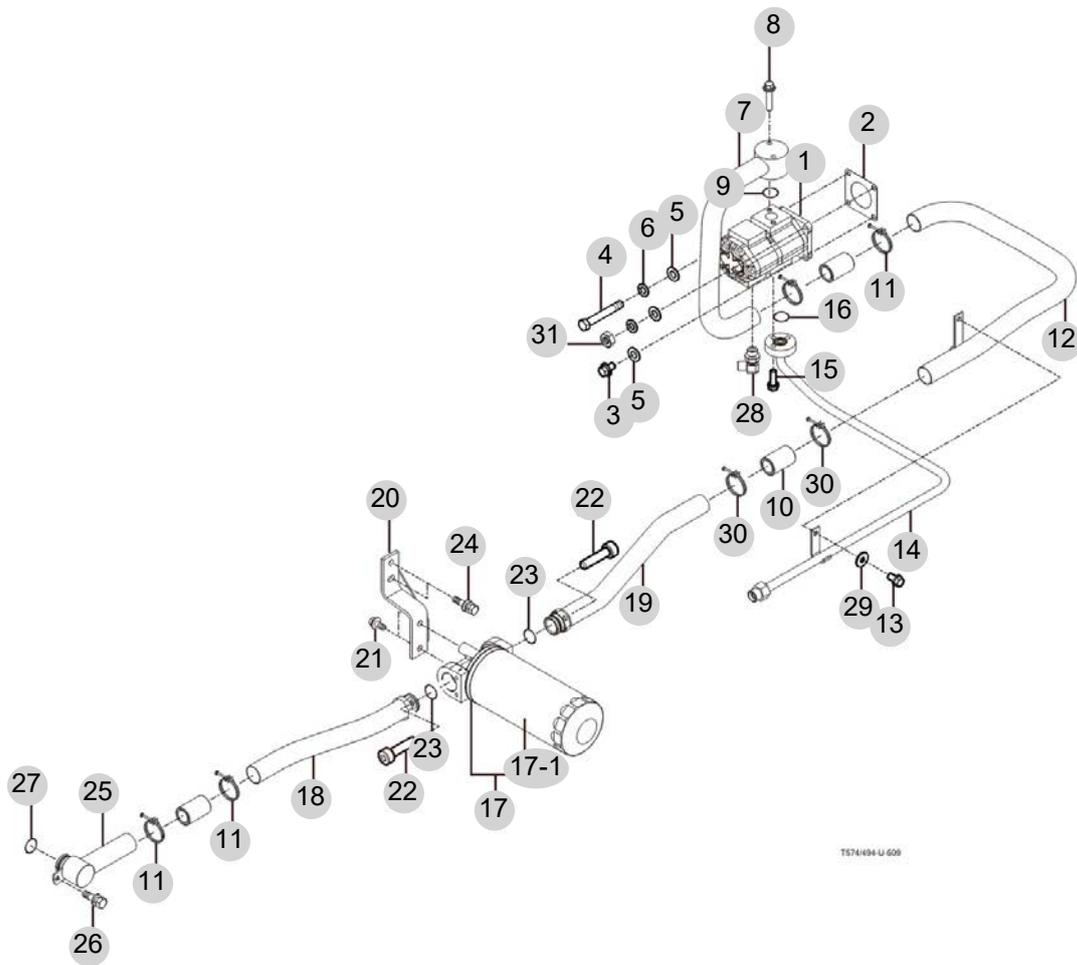

NOTE



FIG 610

T574ST-B

JOYSTICK[SAP 가져오기]에서 생성함.

년/월  
Year/Month

2022-12

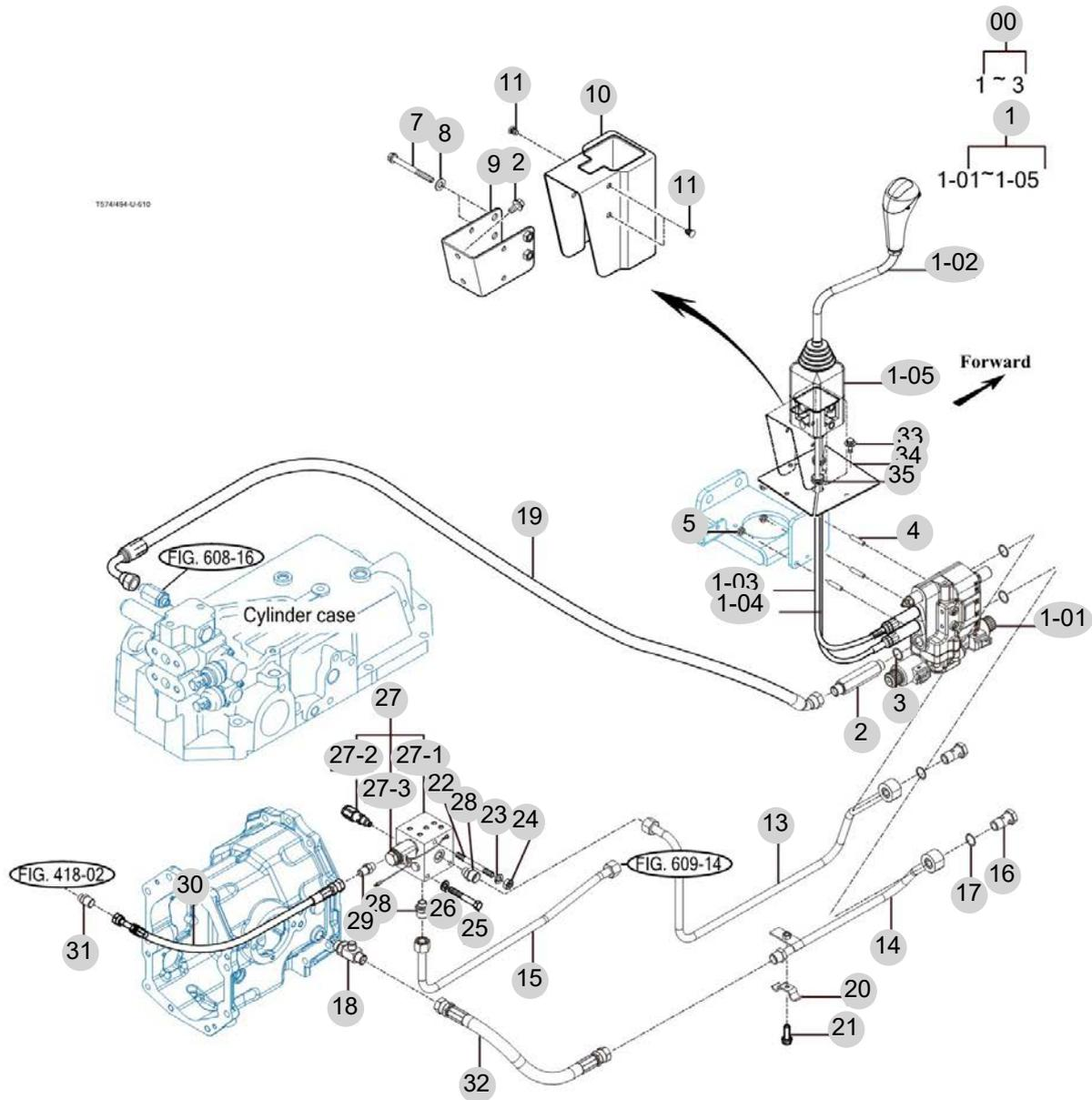

NOTE



FIG 610

T574ST-B

JOYSTICK

년/월  
Year/Month

2022-12

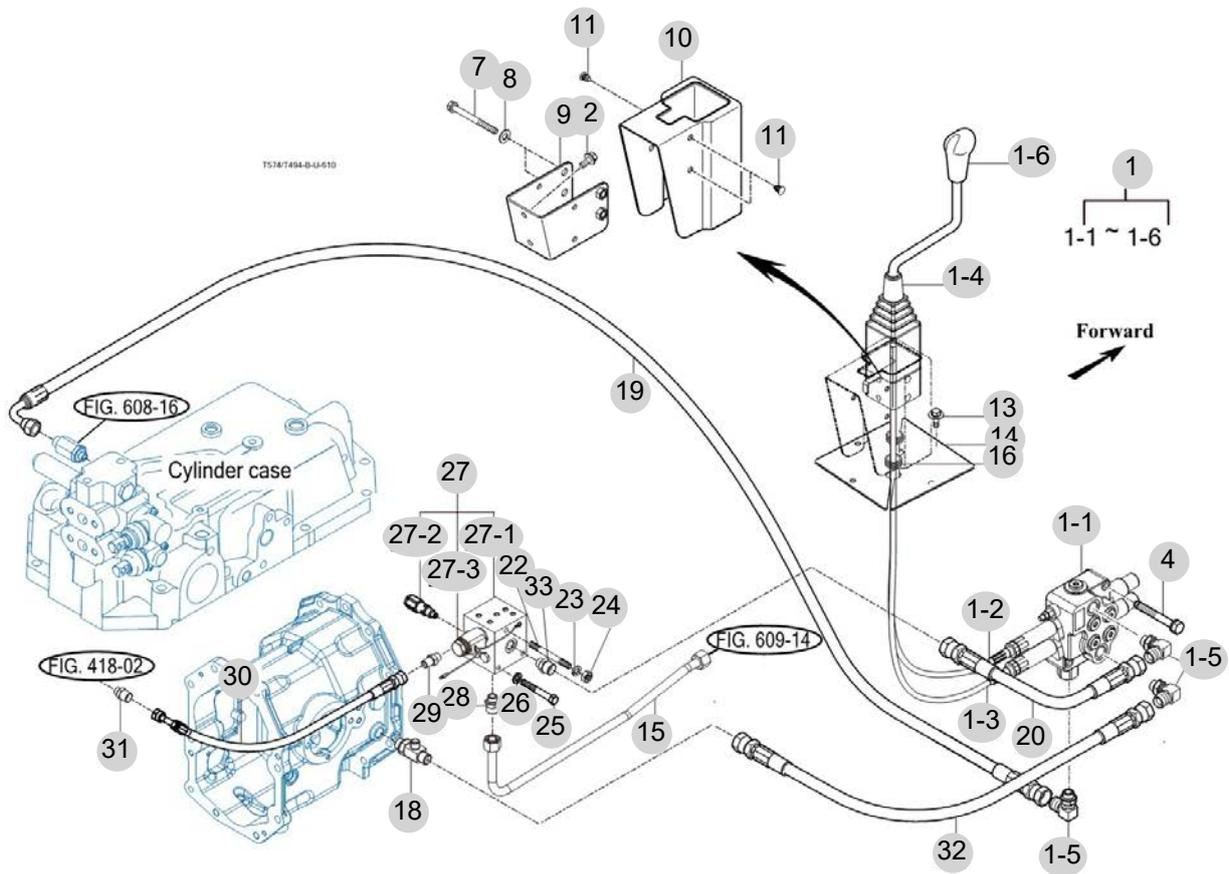

NOTE



FIG 612

HITCH & 3-POINT LINK

년/월  
Year/Month

2022-12

T574ST-B

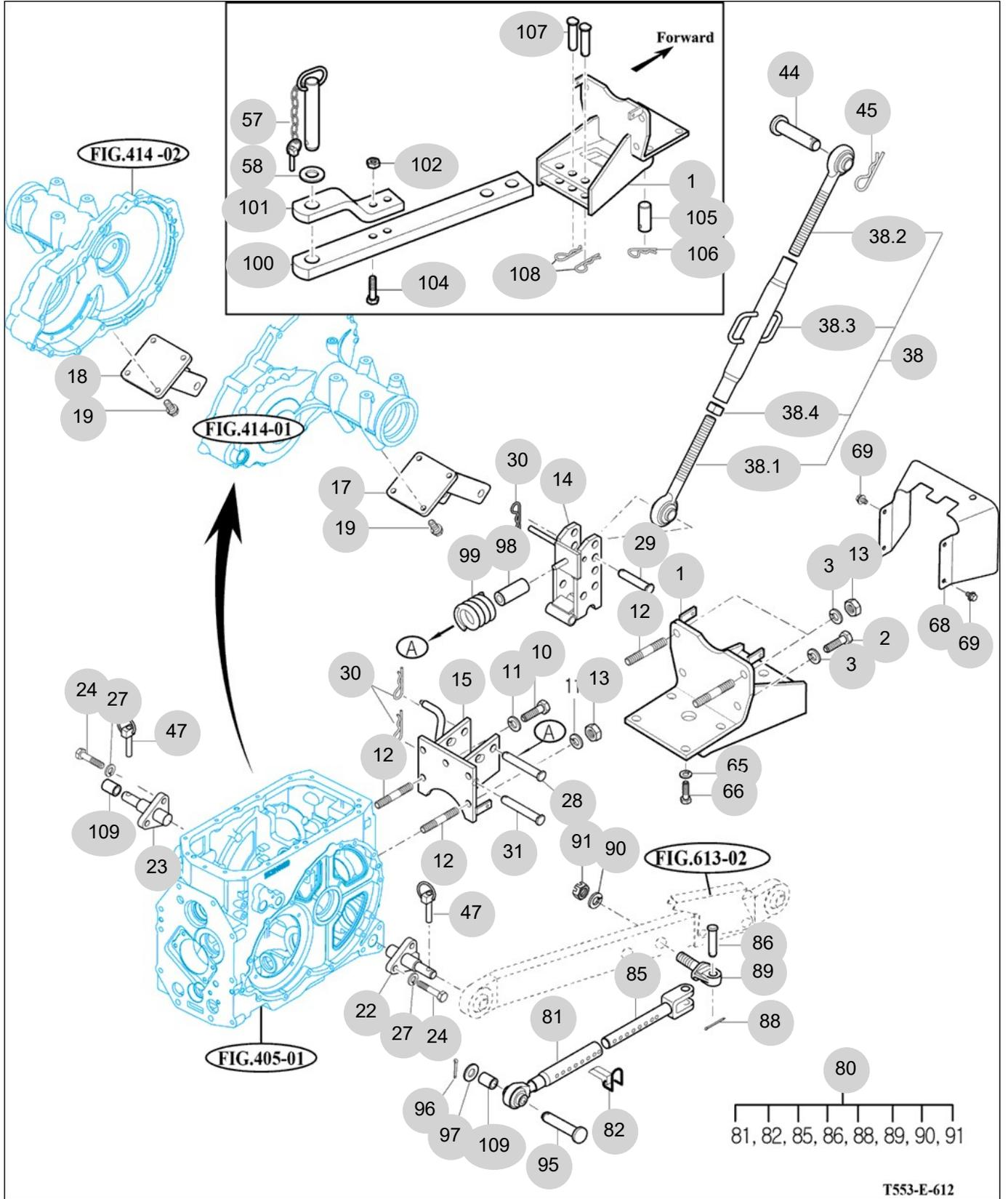

T553-E-612

NOTE

FIG 612		HITCH & 3-POINT LINK					년/월 Year/Month		
							2022-12		
T574ST-B		KEY NO	PART NO	DESCRIPTION	SPEC	QTY	REPAIR	EFFECTIVE DATE	REMARKS
612	1	15175202001GB	BRACKET COMP, SWING DRAW BAR			1			
612	1	15175202002GB	BRACKET COMP, SWING DRAW BAR			1			
612	1	15175202003GB	BRACKET COMP, SWING DRAW BAR			1			
612	2	V2013616035	BOLT, HEX	M16X35		2			
612	3	V4011600160	WASHER, SPRING	M16		4			
612	10	V2013616035	BOLT, HEX	M16X35		3			
612	11	V4011600160	WASHER, SPRING	M16		5			
612	12	V2513416035	BOLT, STUD/2	M16X35		4			
612	13	V3043600160	NUT, HEX/2	M16		4			
612	14	16735222102GB	LINK COMP	1X1X1		1			
612	15	15185222000GB	BRACKET COMP			1			
612	17	14525254100GB	BRACKET COMP, RR			1			
612	18	14525254100GB	BRACKET COMP, RR			1			
612	19	V2173612030	BOLT, HEX/S	M12X30		8			
612	22	15685252204	PIN COMP, LH			1			
612	23	15685252801	PIN COMP, RH			1			
612	24	V2013614040	BOLT, HEX	M14X40		6			
612	27	V4011600140	WASHER, SPRING	M14		6			
612	28	15645250010	PIN, 19X122	D=19		1			
612	29	15645220020	PIN, 19X95	D=19		1			
612	30	14445140051	PIN, 19	D=4.5		3			
612	31	15645250010	PIN, 19X122	D=19		1			
612	38	16505245501GB	LINK ASSY, TOP LINK			1			
612	38	16505245502GB	TOP LINK ASSY			1			
612	38.1	16505245510	LINK COMP, RH TOP LINK	1X1X1		1			
612	38.2	16505245520	LINK COMP, LH TOP LINK	1X1X1		1			
612	38.3	14555140251	TURNBUCKLE COMP			1			
612	38.4	16505245530	NUT, HEX	1X1X1		1			
612	44	15645220011	PIN, 19X86	D=19		1			
612	45	14445140051	PIN, 19	D=4.5		1			
612	47	14215020020	PIN, LINK			2			
612	57	S0973063031	PIN ASSY	1X1X1		1			
612	58	15252470010	RUBBER, CUSHION			1			
612	65	V4011600140	WASHER, SPRING	M14		4			
612	66	V2013614035	BOLT, HEX	M14X35		4			
612	68	13605200012GB	COVER, SHIELD	1X1X1		1			
612	69	V2183608016	BOLT, HEX/SP	M8X16		4			
612	80	15155253000GB	LINK ASSY, ADJUSTER	570*60*50		2			
612	81	15155253100	ROD SUB, FR	44*320*60		2			
612	82	17705254200	PIN	1X1X1		2			
612	85	15155253300	ROD SUB, REAR	340*50*50		2			
612	86	15155253400	PIN, ø20X59	ø20X59		2			
612	88	V5001940035	PIN, SPLIT	4X35		2			
612	89	15155253500	EYEBOLT	66*60*40		2			
612	90	V4111600220	WASHER, PLAIN	M22		2			
NOTE									





FIG 613

LOWER LINK & LIFT ROD

년/월  
Year/Month

2022-12

T574ST-B

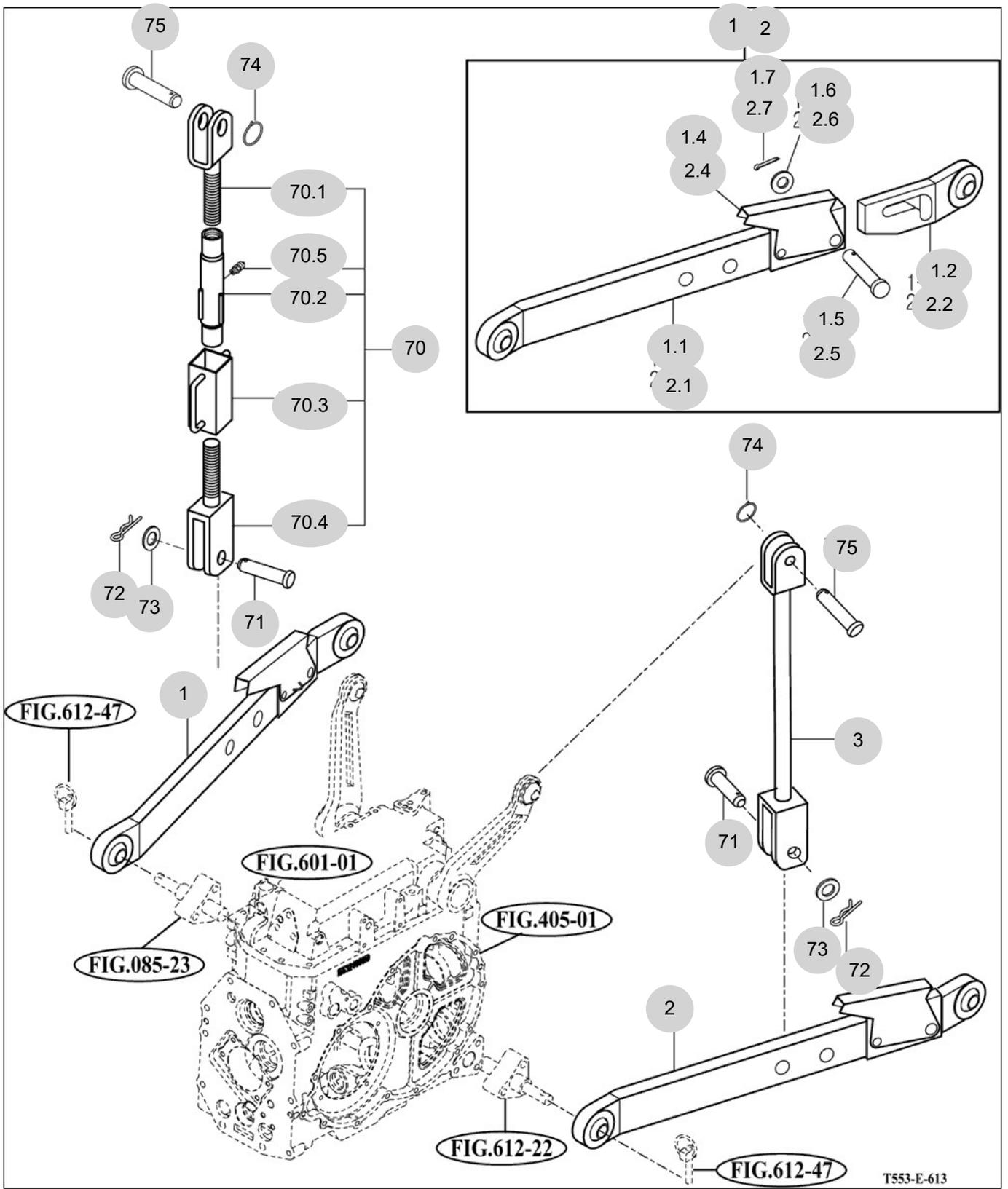

NOTE



## 7. Sheet Metal & Cabin PART NO. T7

FIG 701 BONNET FRAME	221
FIG 702A BONNET (1)	223
FIG 702B BONNET (2)	225
FIG 703 EXTENSION COVER	227
FIG 704A LEVER COVER & STEP	229
FIG 705 FRONT & REAR MOUNTING[SAP 가져오기]에서 생성함.	231
FIG 705 FRONT & REAR MOUNTING	233
FIG 706 SEAT & MAT	235
FIG 709 DOOR	237
FIG 710A FRONT GLASS	240
FIG 711 SIDE GLASS	242
FIG 712 REAR GLASS	244
FIG 713A SUB FENDER & COVER	246
FIG 714A MIRROR	248
FIG 715A HEATER & AIR-CON	250
FIG 715B HEATER & AIR-CON	252
FIG 716 FENDER COVER	254
FIG 717 ROOF	256
FIG 718 CABIN INTERIOR	258

FIG 701

BONNET FRAME

년/월  
Year/Month

T574ST-B

2022-12

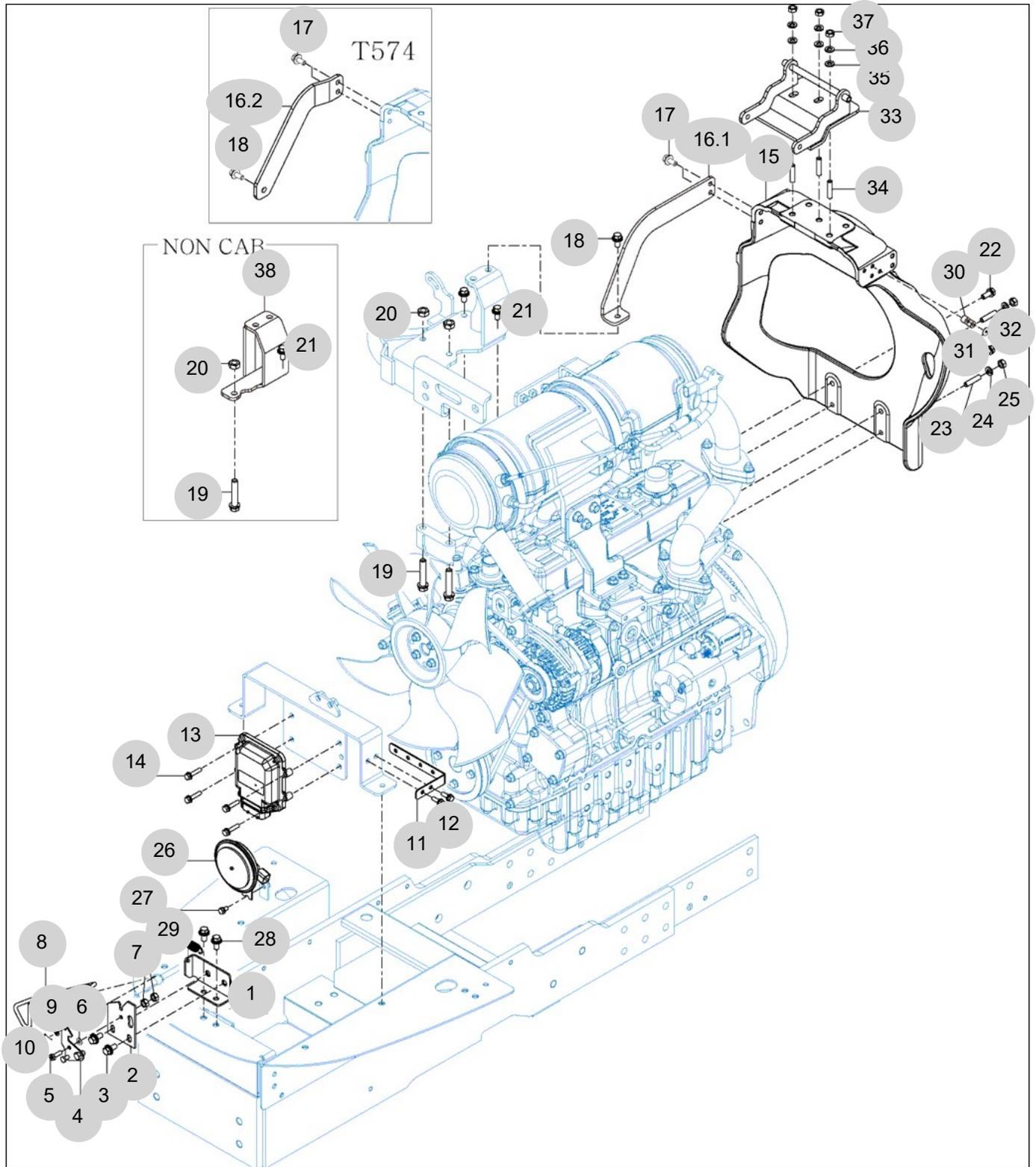

NOTE



FIG 702A

T574ST-B

BONNET (1)

년/월  
Year/Month

2022-12

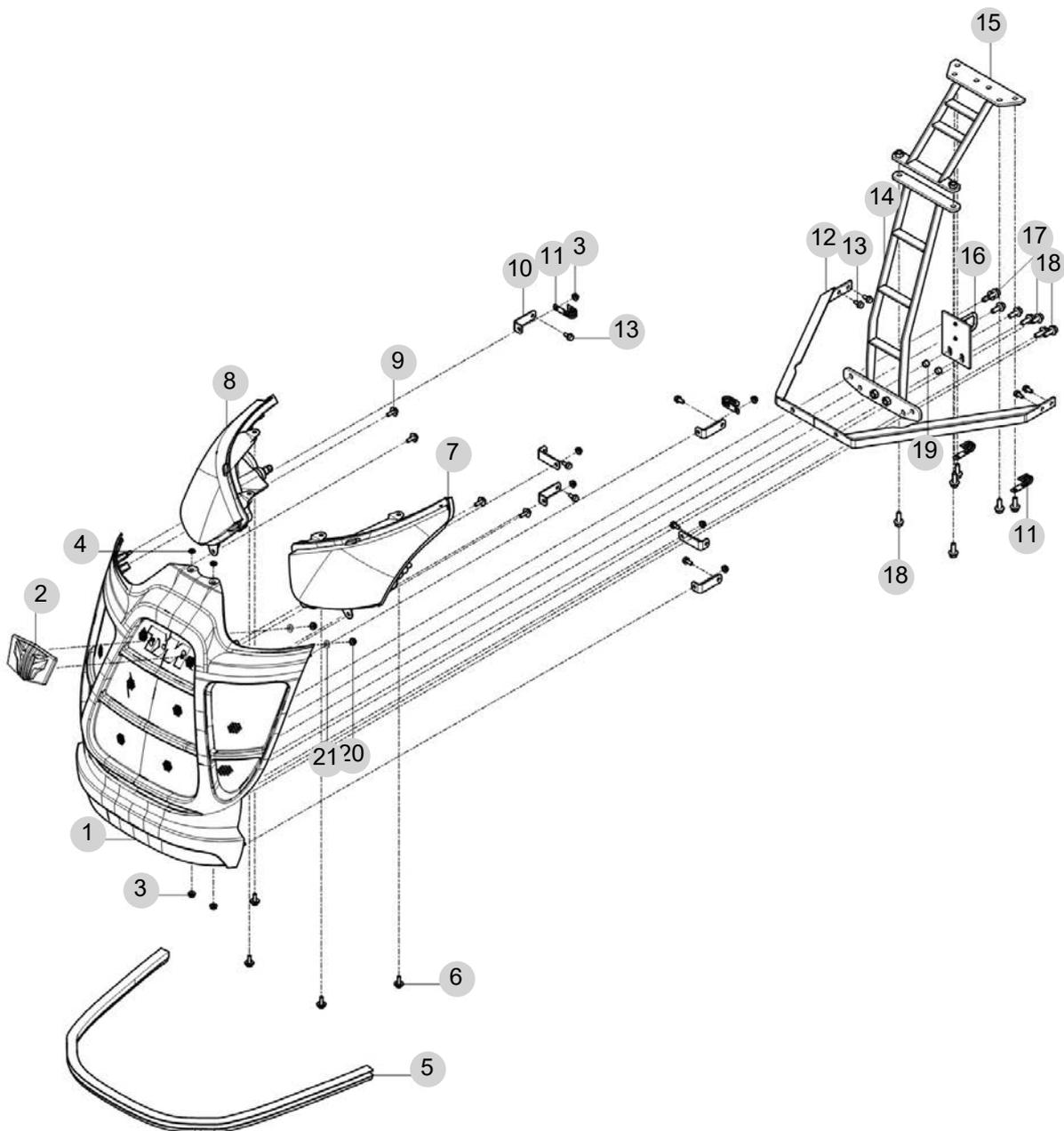

NOTE





FIG 702B

T574ST-B

BONNET (2)

년/월  
Year/Month

2022-12

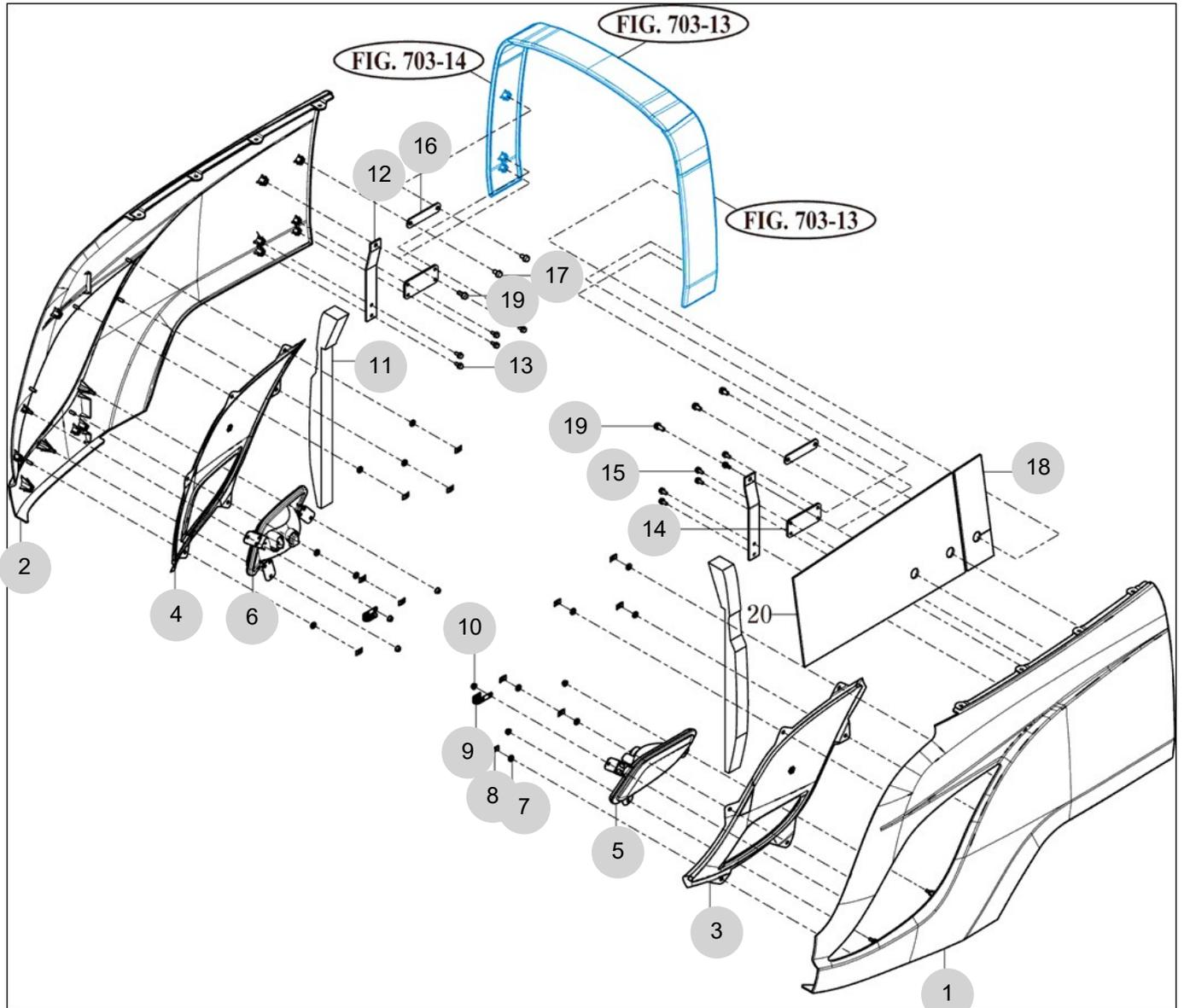

NOTE



FIG 703

EXTENSION COVER

년/월  
Year/Month

2022-12

T574ST-B

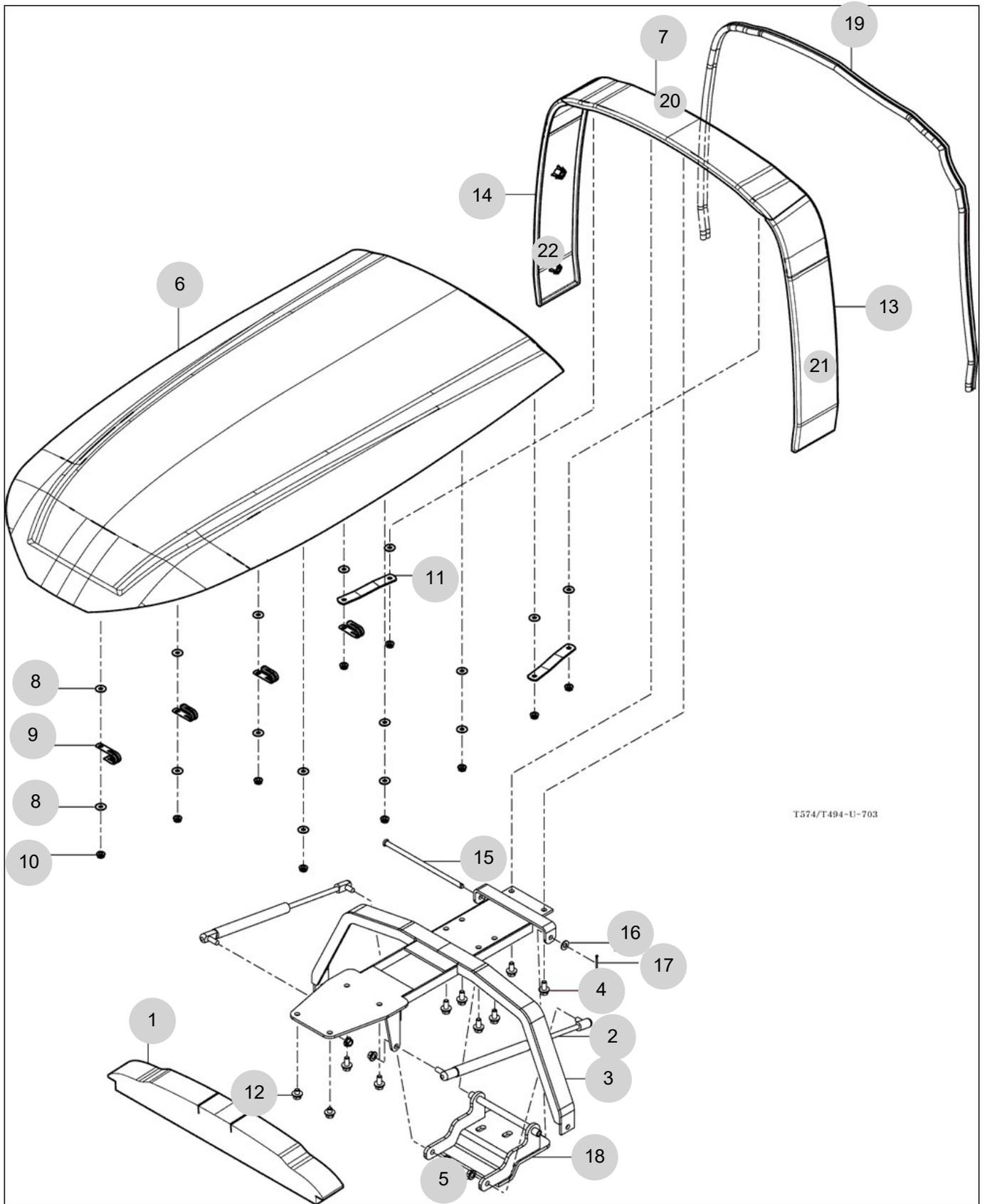

T574/T494-U-703

NOTE



FIG 704A

LEVER COVER & STEP

년/월  
Year/Month

2022-12

T574ST-B

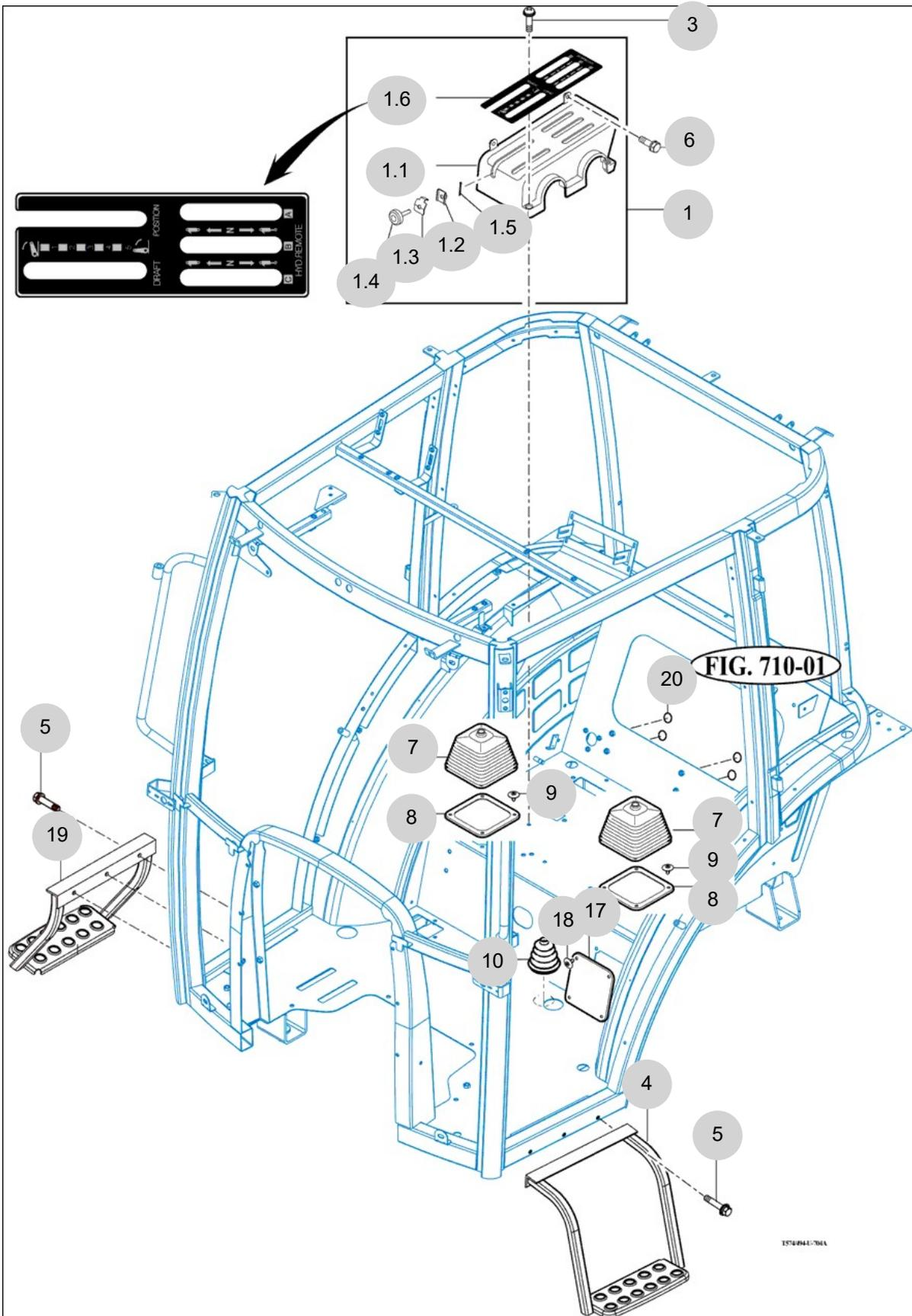

NOTE



FIG 705

T574ST-B

FRONT & REAR MOUNTING[SAP 가져오기]에서 생성함.

년/월  
Year/Month

2022-12

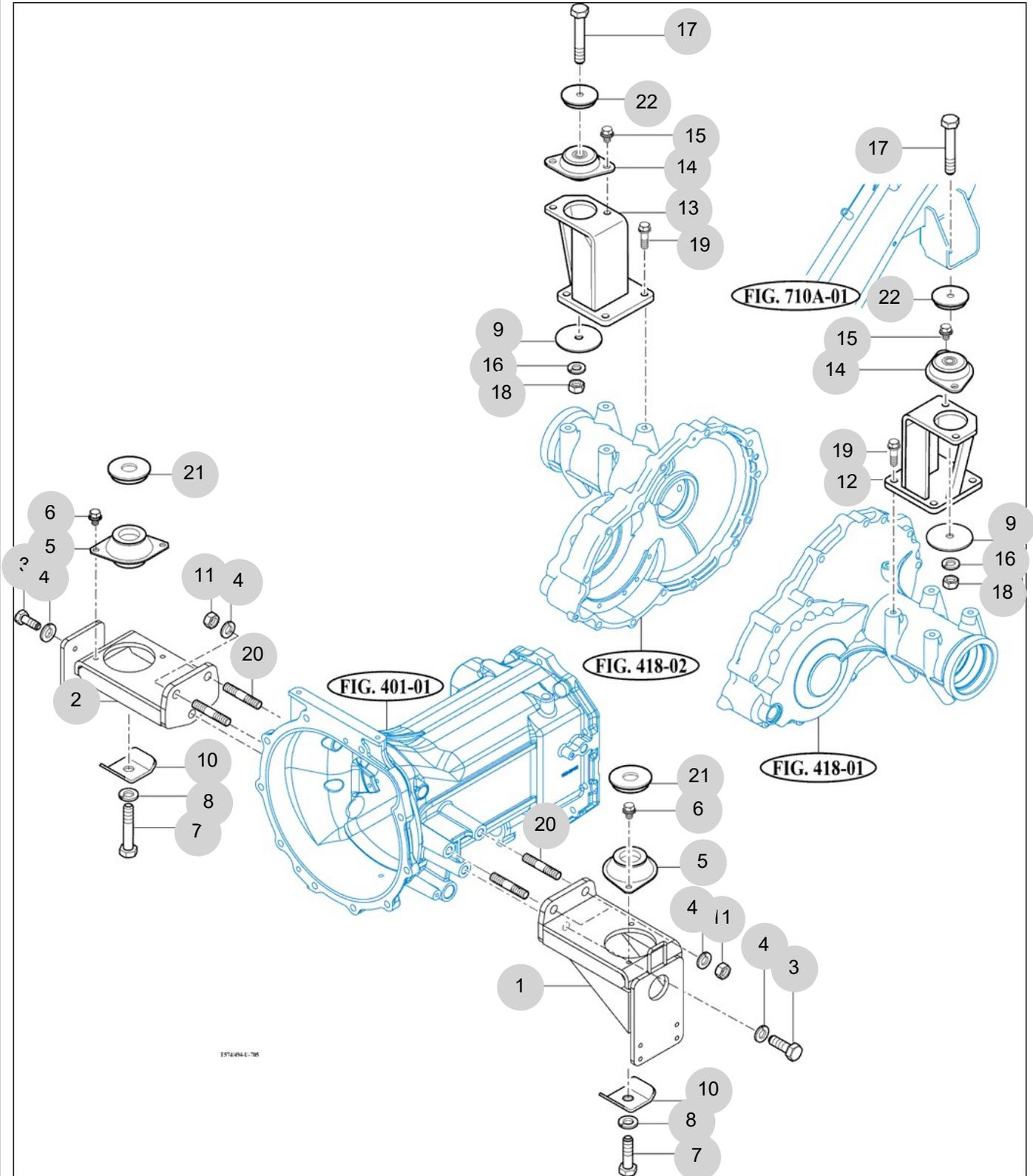

NOTE





FIG 705

T574ST-B

FRONT & REAR MOUNTING

년/월  
Year/Month

2022-12

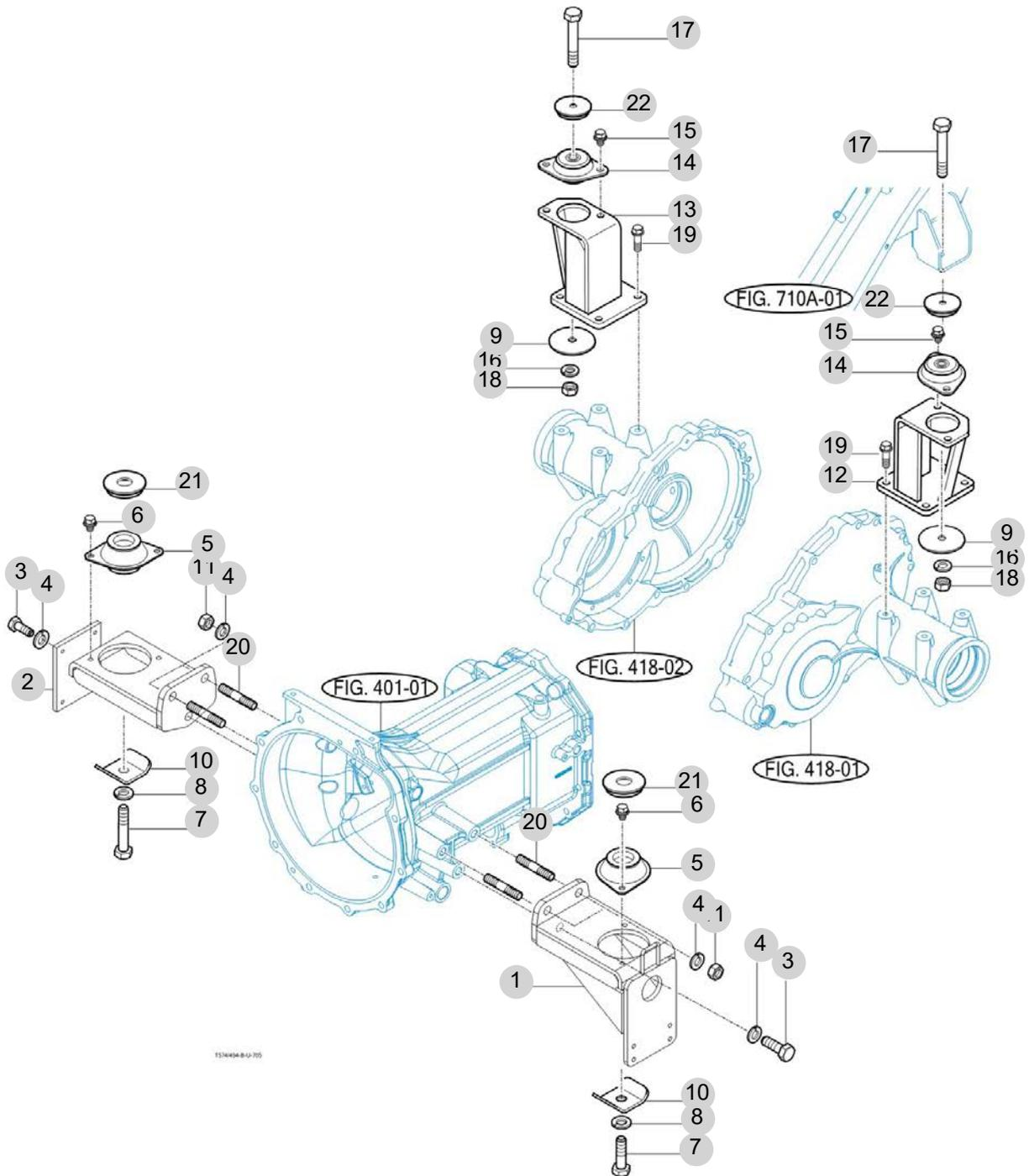

NOTE



FIG 706

SEAT & MAT

년/월  
Year/Month

2022-12

T574ST-B

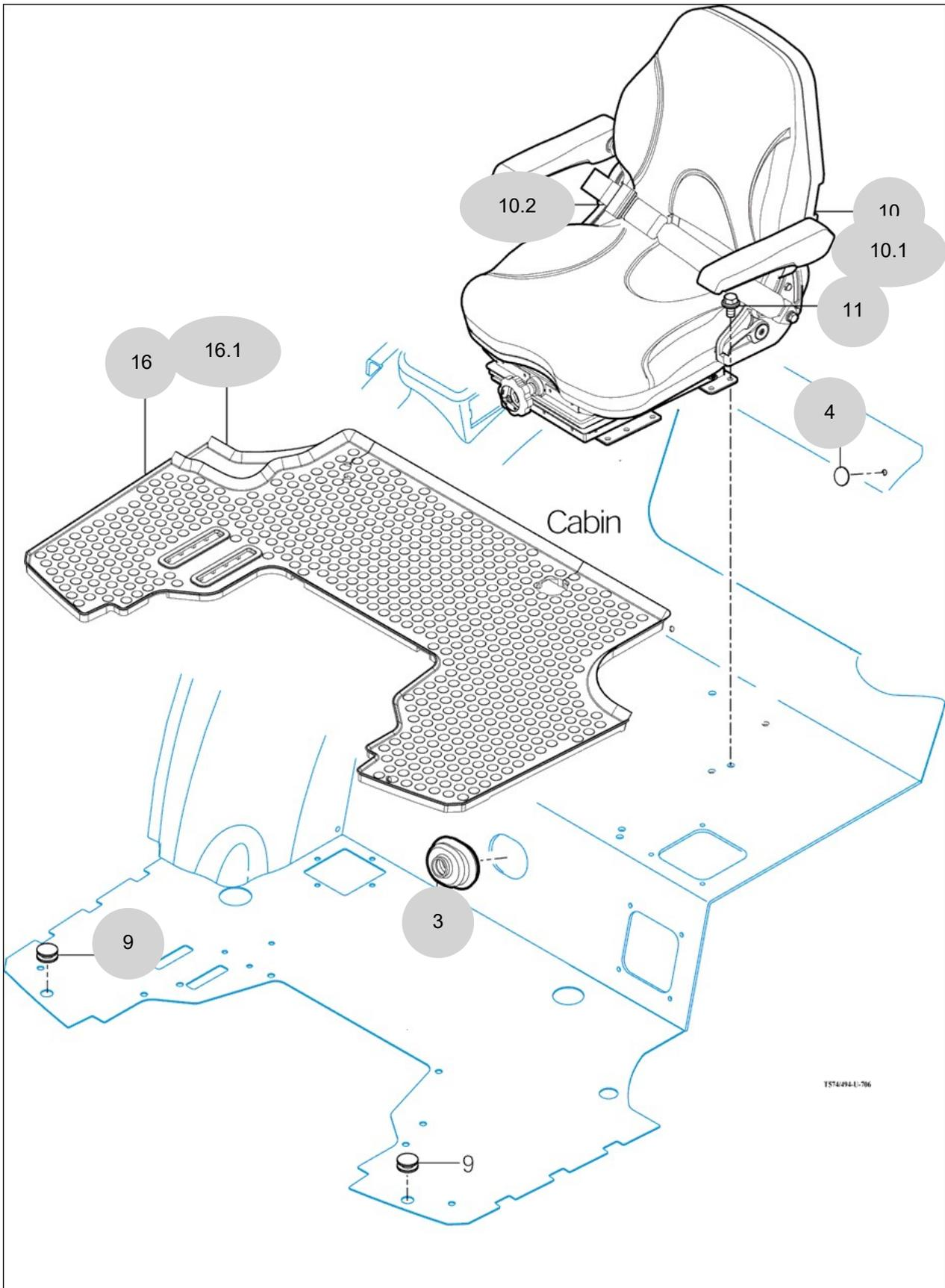

NOTE



FIG 709

DOOR

년/월  
Year/Month

T574ST-B

2022-12

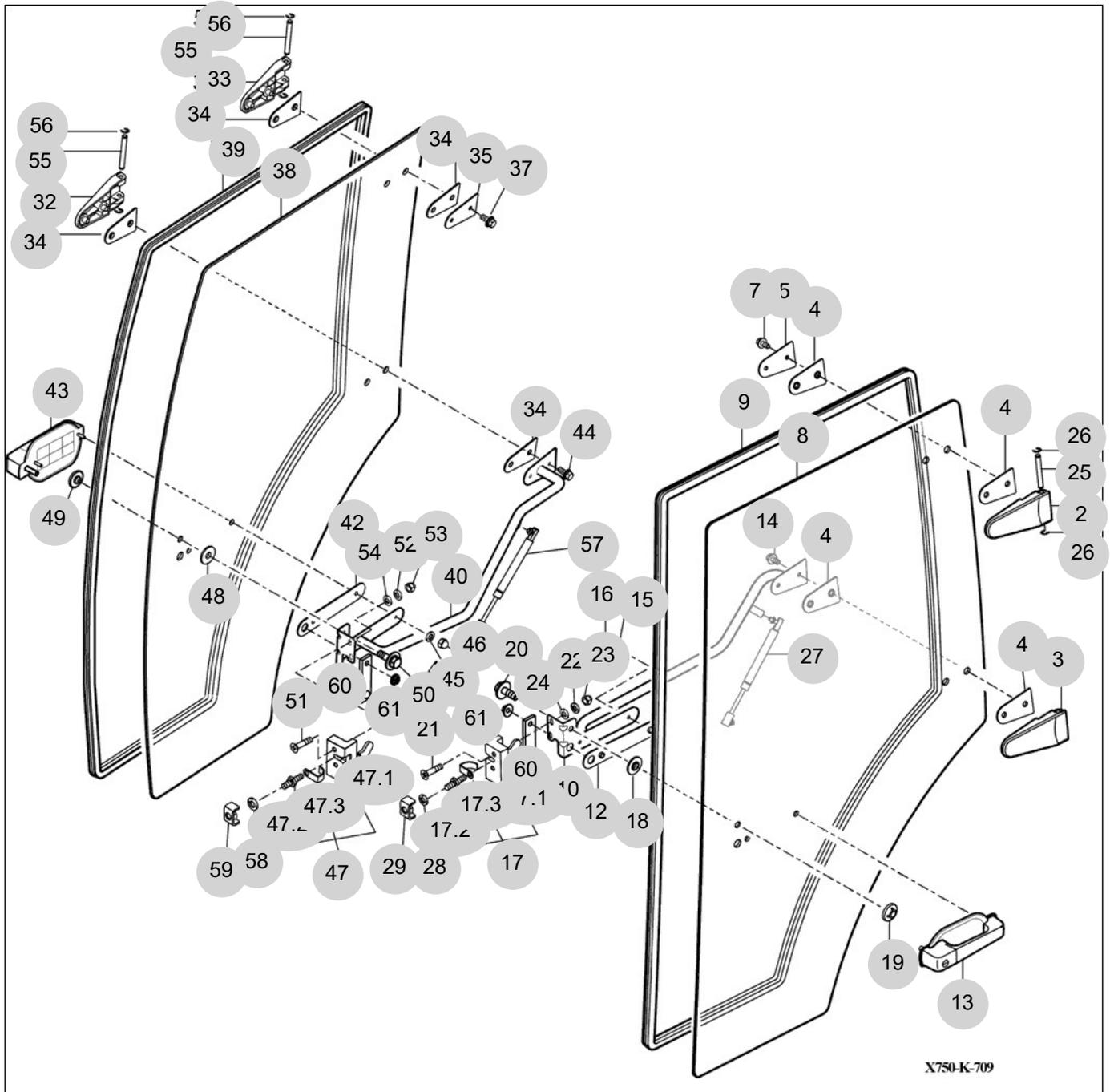

NOTE

FIG 709		DOOR					년/월 Year/Month		
							2022-12		
T574ST-B		KEY NO	PART NO	DESCRIPTION	SPEC	QTY	REPAIR	EFFECTIVE DATE	REMARKS
709	2	14527052300	HINGE COMP , UPR/LH	1X1X1	1				
709	3	14527052400	HINGE COMP , UPR/RH	1X1X1	1				
709	4	14527052110	GASKET , DOOR HINGE	1X1X1	4				
709	5	14527052120GB	PLATE , DOOR HINGE	1X1X1	1				
709	7	V2183608020	BOLT , HEX/SP	M8X20	2				
709	8	14527052131	GLASS , LH/ DOOR	6T	1				
709	9	14527052140	INSULATOR/DOOR	1X1X1	1				
709	10	14527052500GB	GUIDE COMP ,LH/ DOOR	1X1X1	1				
709	12	14527052150	GASKET,DOOR GRIP	1X1X1	1				
709	13	17827052600	GRIP ASSY, LOCK/HANDLE		1				
709	14	V2183608020	BOLT , HEX/SP	M8X20	2				
709	15	V4011600060	WASHER , SPRING	M6	2				
709	16	V3402700060	NUT , HEX CAP	M6	2				
709	17	17827052700	LATCH SET , LH/DOOR		1				
709	17.1	17827052710	LOCK ASSY, LH/DOOR		1				
709	17.2	14527052720	STRIKER	1X1X1	1				
709	17.3	14527052730	GUARD	1X1X1	1				
709	18	15817401130	GROMMET , 13X17X02		1				
709	19	14527042500	NUT COMP , GLASS	1X1X1	1				
709	20	V2193606012	BOLT , HEX/SPL	M6X12	1				
709	21	V1122608040	SCREW , C/R FLAT	M8X40	2				
709	22	V4011600080	WASHER , SPRING	M8	2				
709	23	V3412700080	NUT , SMALL CAP	M8	2				
709	24	V4111600080	WASHER , PLAIN	M8	2				
709	25	14527041110	PIN, HINGE DOOR	D=8	2				
709	26	V7082400070	E-RING	7	4				
709	27	14527301080	DAMPER ASSY , DOOR	1X1X1	1				
709	28	V4011600100	WASHER , SPRING	M10	1				
709	29	14527062500GB	BRACKET COMP , DOOR LOCK	1X1X1	1				
709	32	14527052300	HINGE COMP , UPR/LH	1X1X1	1				
709	33	14527052400	HINGE COMP , UPR/RH	1X1X1	1				
709	34	14527052110	GASKET , DOOR HINGE	1X1X1	4				
709	35	14527052120GB	PLATE , DOOR HINGE	1X1X1	1				
709	37	V2183608020	BOLT , HEX/SP	M8X20	2				
709	38	14527053131	GLASS , RH/ DOOR	6T	1				
709	39	14527052140	INSULATOR/DOOR	1X1X1	1				
709	40	17827053500GB	GUIDE COMP , RH/DOOR		1				
709	42	14527052150	GASKET,DOOR GRIP	1X1X1	1				
709	43	17827052600	GRIP ASSY, LOCK/HANDLE		1				
709	44	V2183608020	BOLT , HEX/SP	M8X20	2				
709	45	V4011600060	WASHER , SPRING	M6	2				
709	46	V3402700060	NUT , HEX CAP	M6	2				
709	47	17827053700	LATCH SET , RH/DOOR		1				
709	47.1	17827053710	LOCK ASSY , RH/DOOR		1				
709	47.2	14527052720	STRIKER	1X1X1	1				
NOTE									



FIG 710A

FRONT GLASS

년/월  
Year/Month

T574ST-B

2022-12

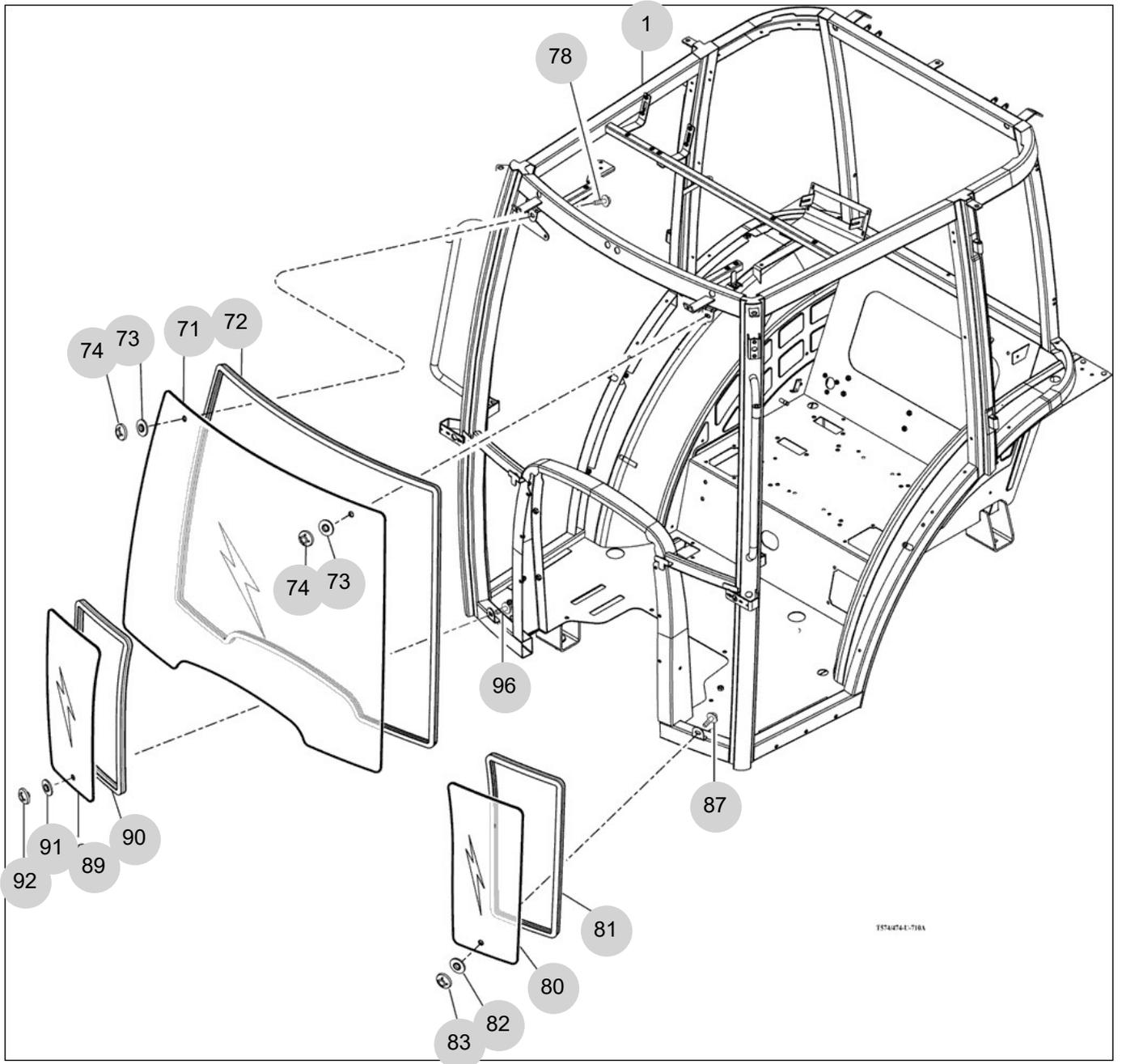

NOTE





FIG 711

SIDE GLASS

년/월  
Year/Month

2022-12

T574ST-B

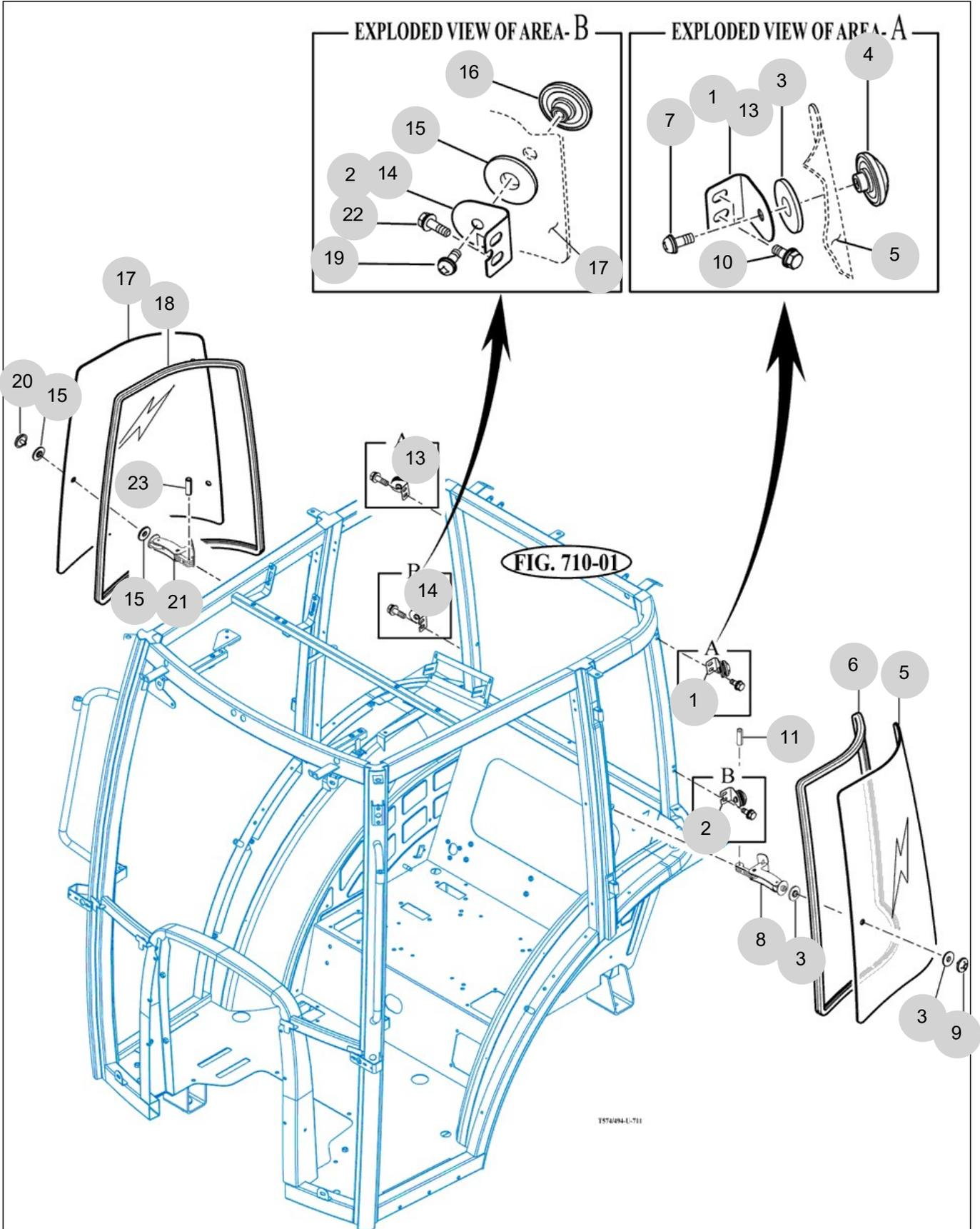

NOTE



FIG 712

REAR GLASS

년/월  
Year/Month

T574ST-B

2022-12

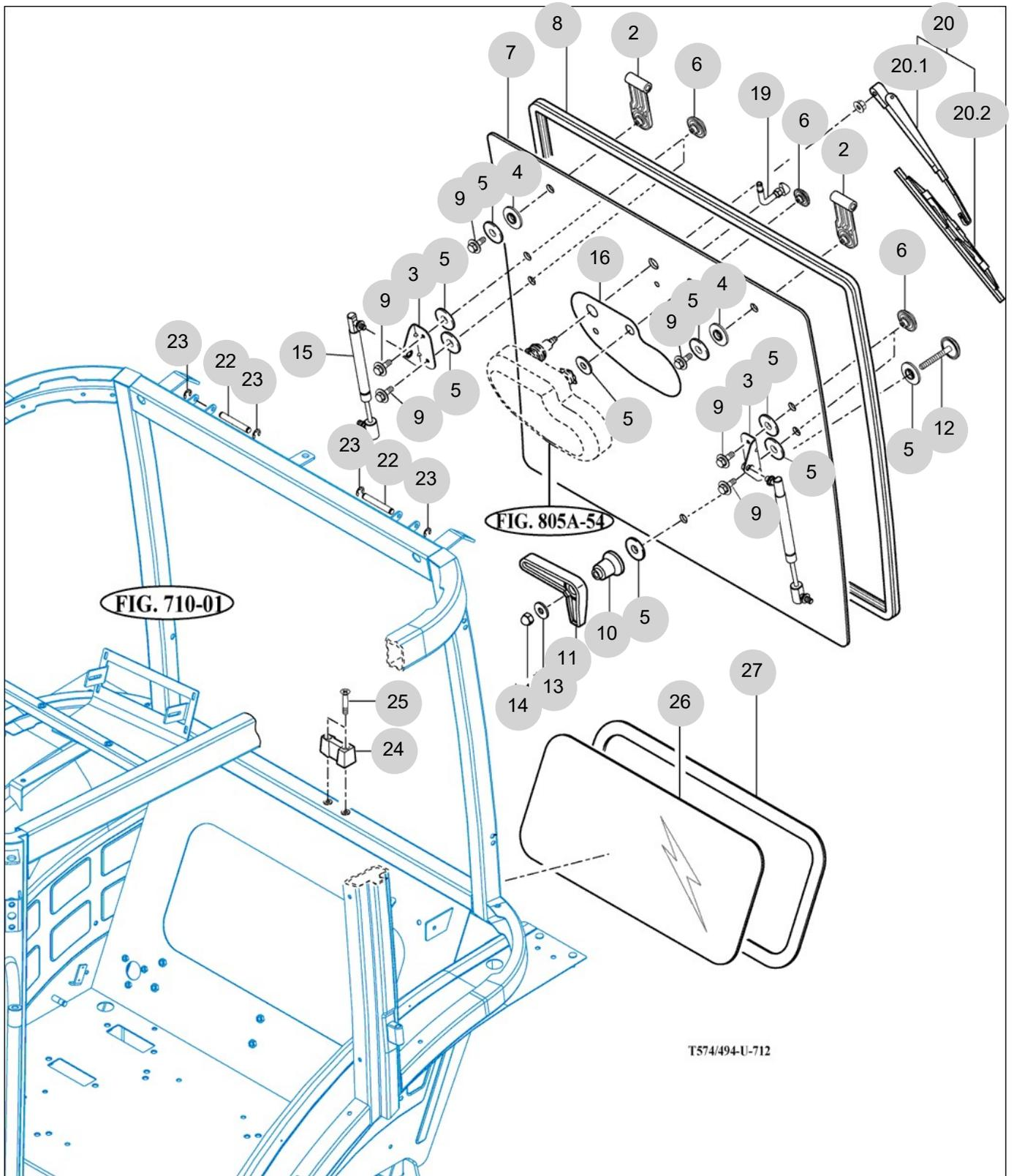

NOTE



FIG 713A

SUB FENDER & COVER

년/월  
Year/Month

2022-12

T574ST-B

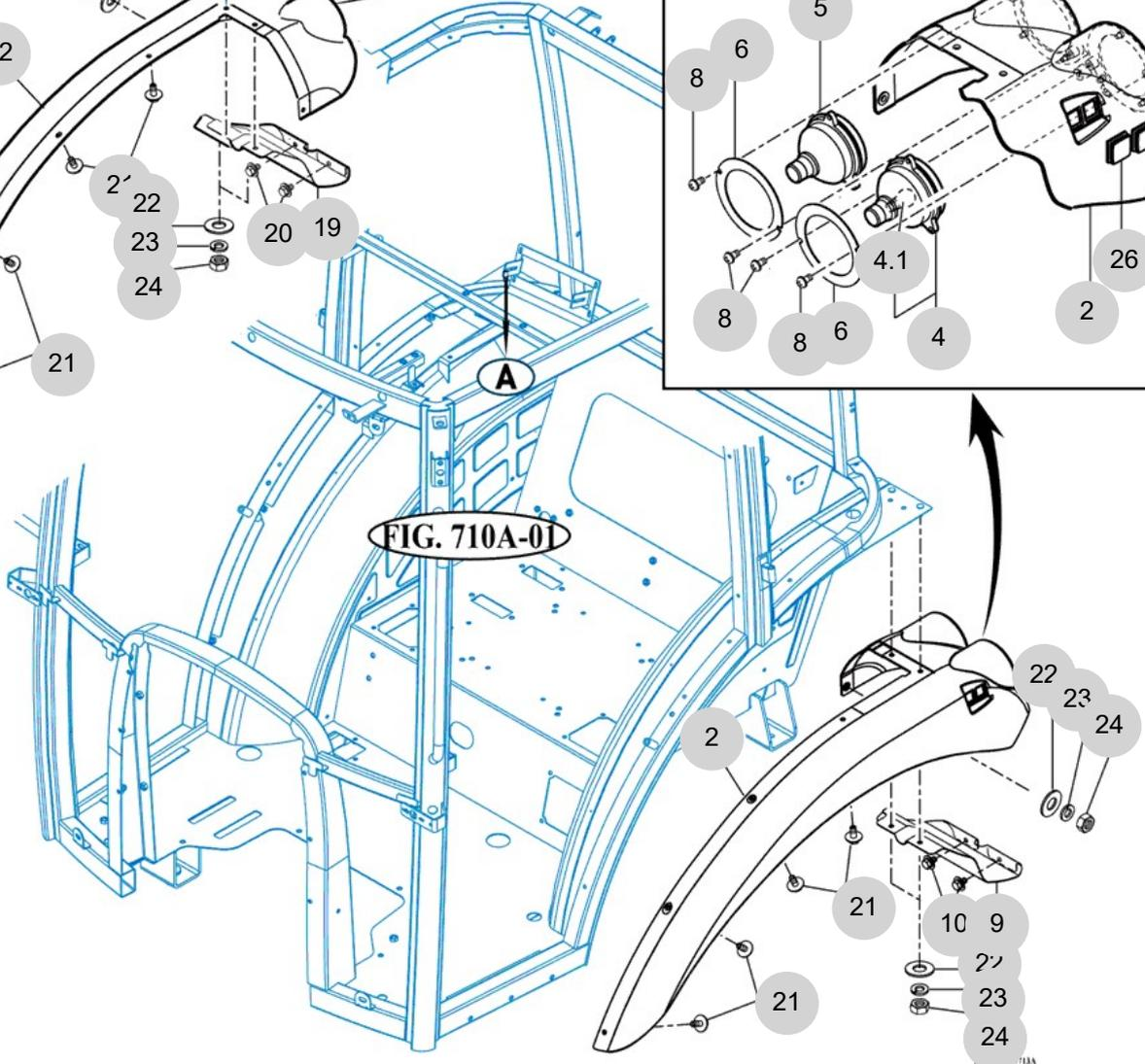
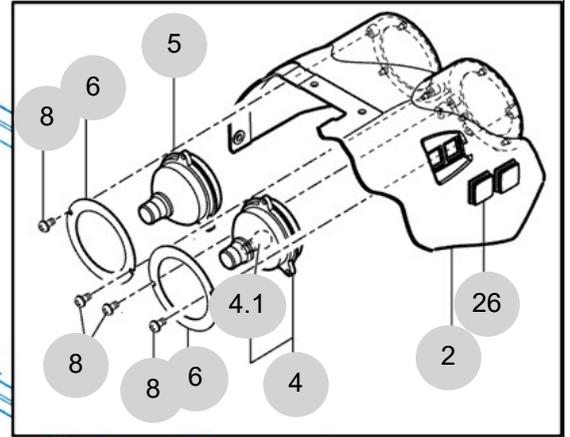
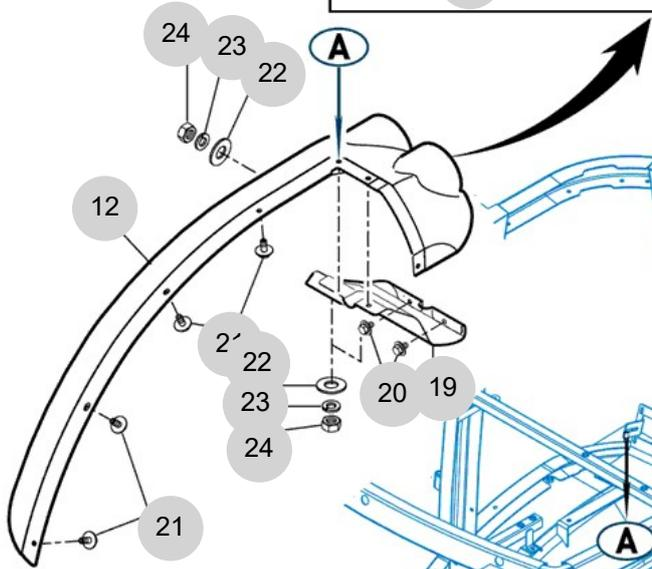
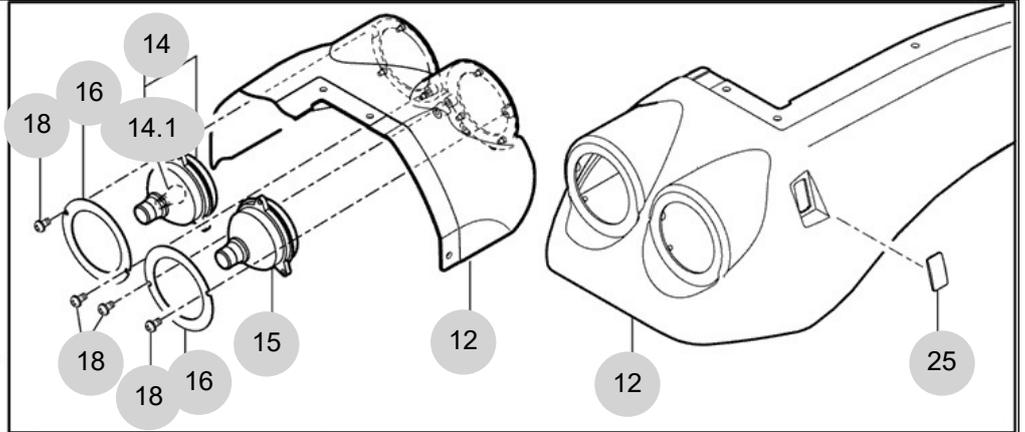
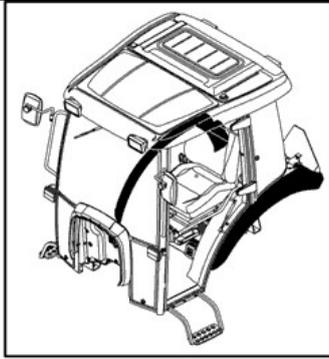

FIG. 710A-01

NOTE



FIG 714A

T574ST-B

MIRROR

년/월  
Year/Month

2022-12

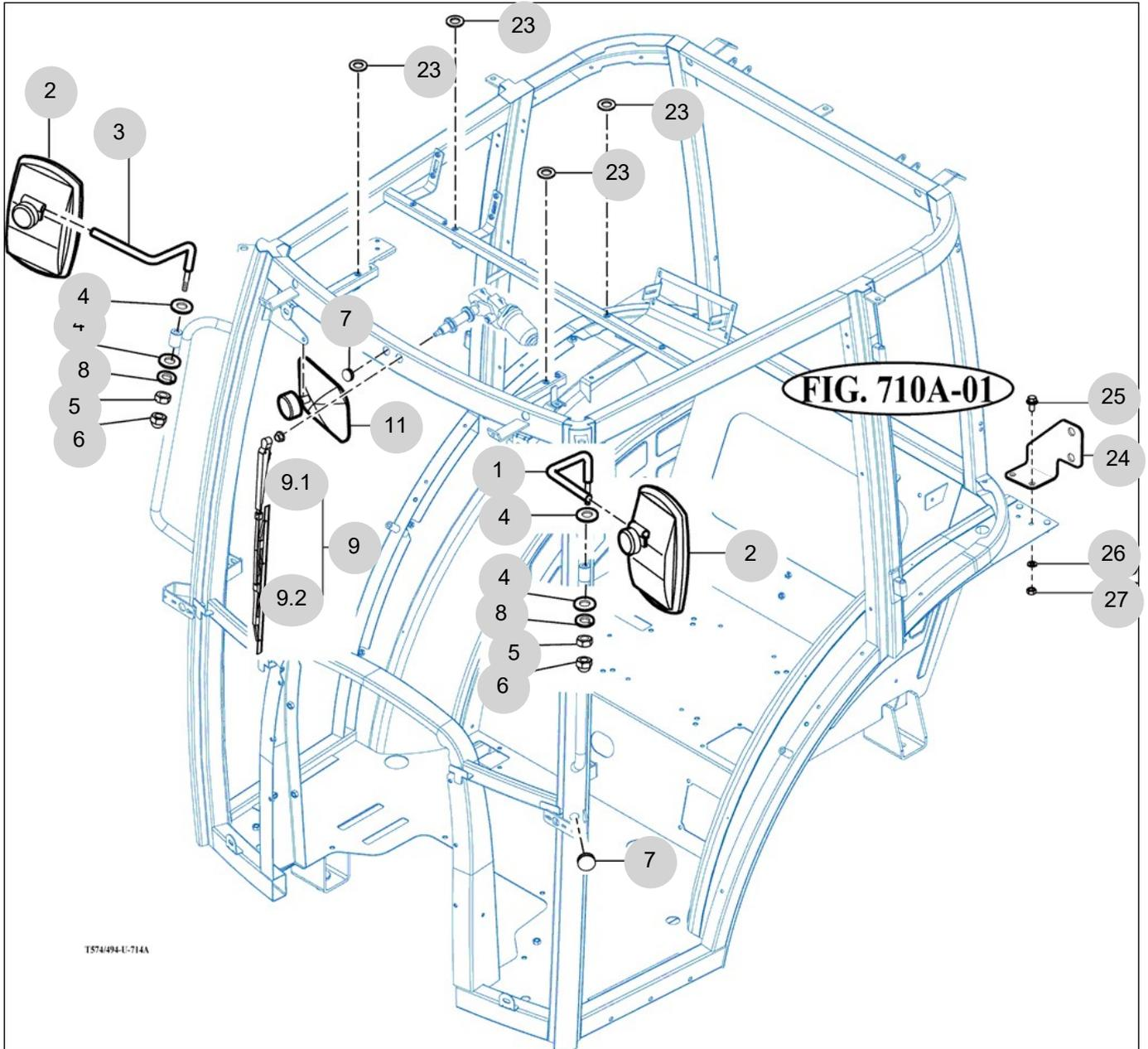

NOTE





FIG 715A

HEATER & AIR-CON

년/월  
Year/Month

2022-12

T574ST-B

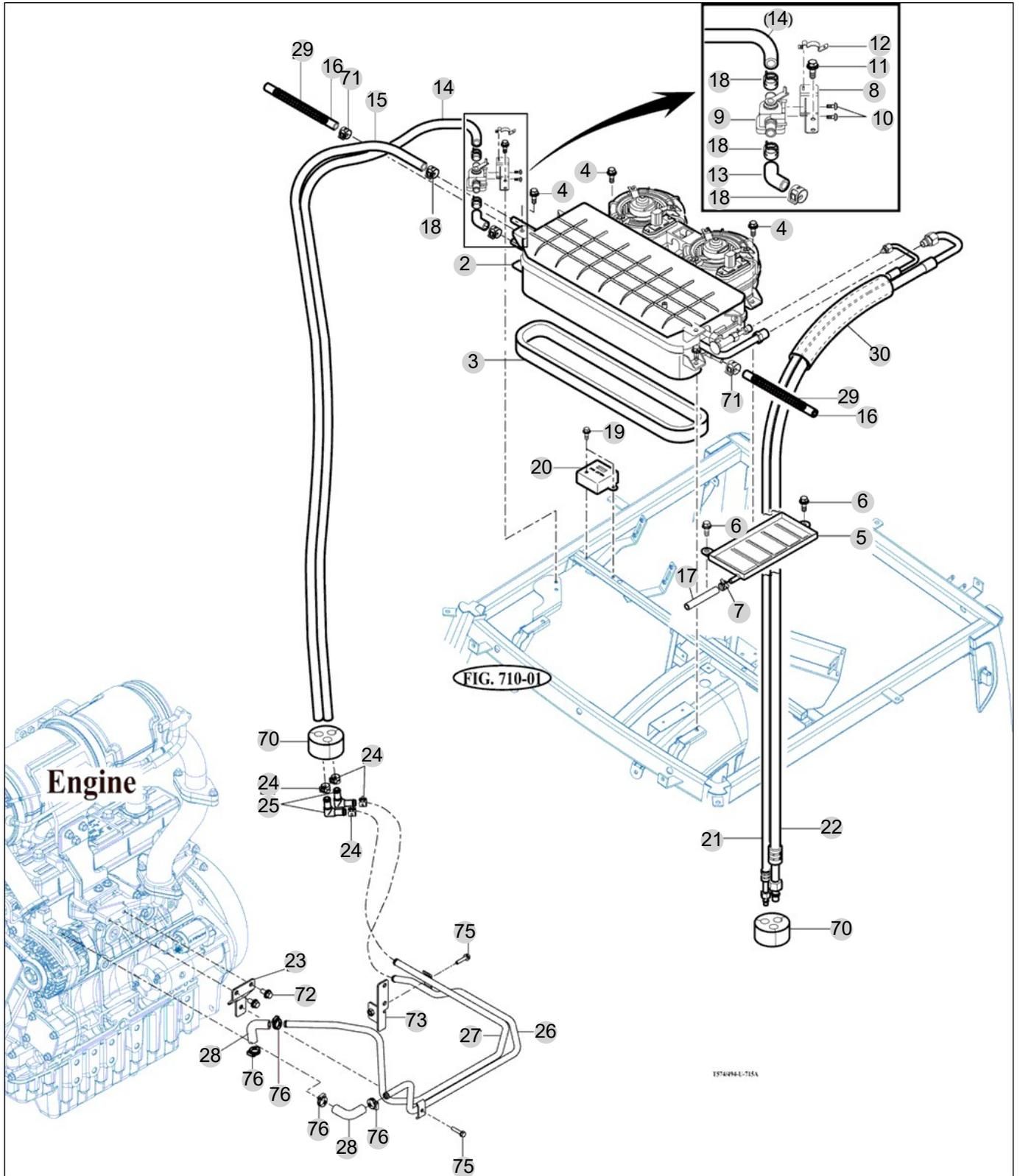

NOTE



FIG 715B

HEATER & AIR-CON

년/월  
Year/Month

2022-12

T574ST-B

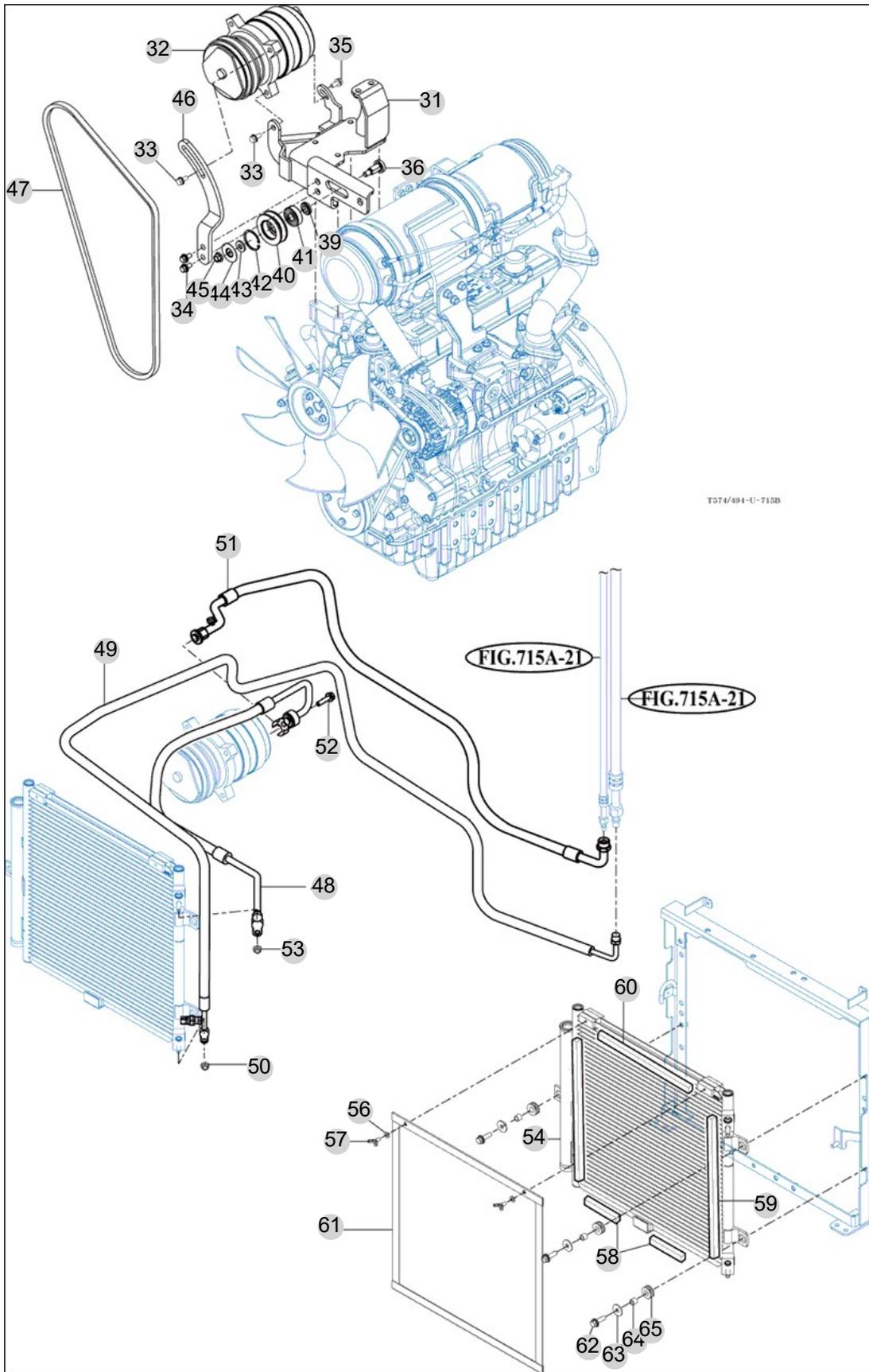

NOTE



FIG 716

FENDER COVER

년/월  
Year/Month

2022-12

T574ST-B

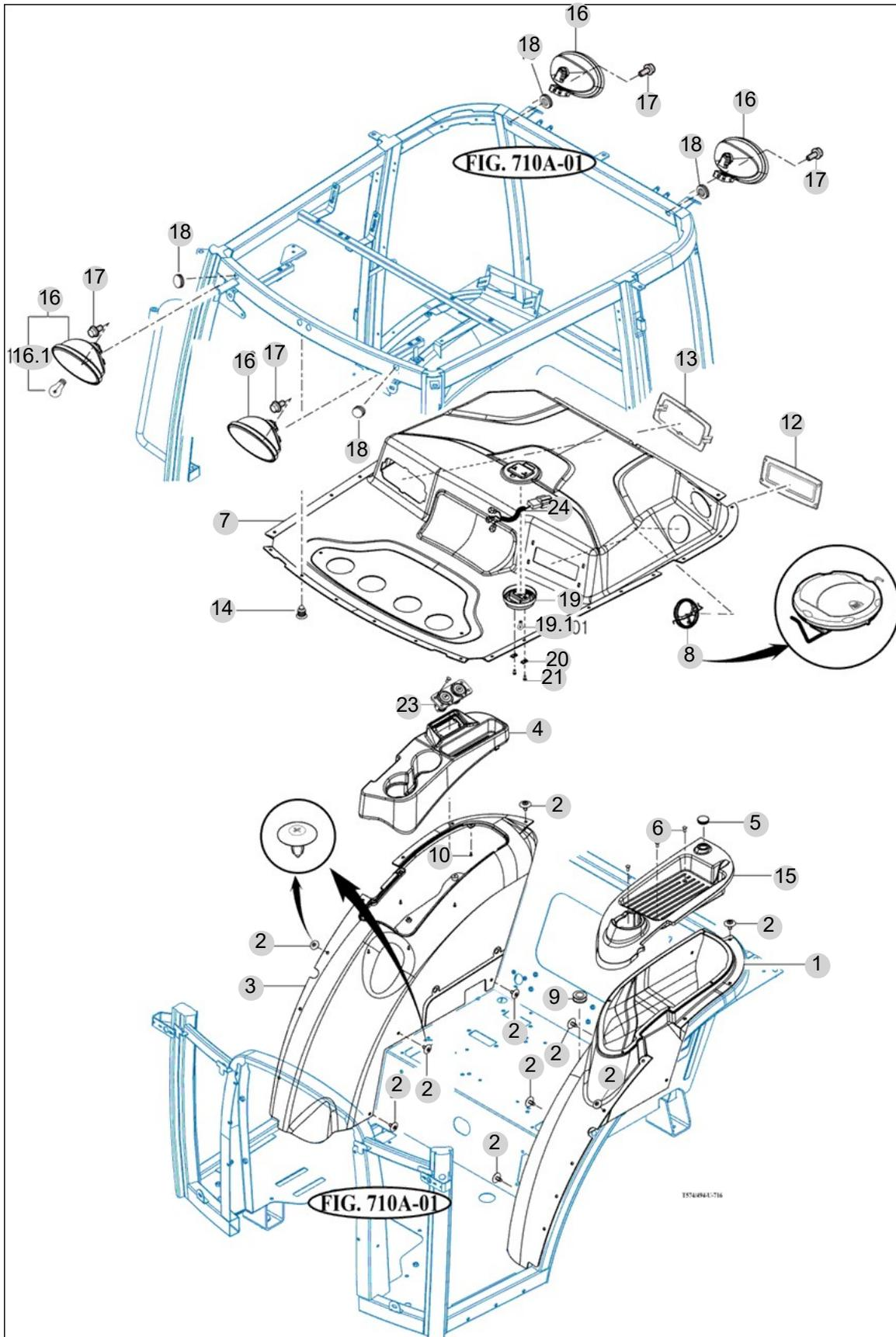

NOTE



FIG 717

T574ST-B

ROOF

년/월  
Year/Month

2022-12

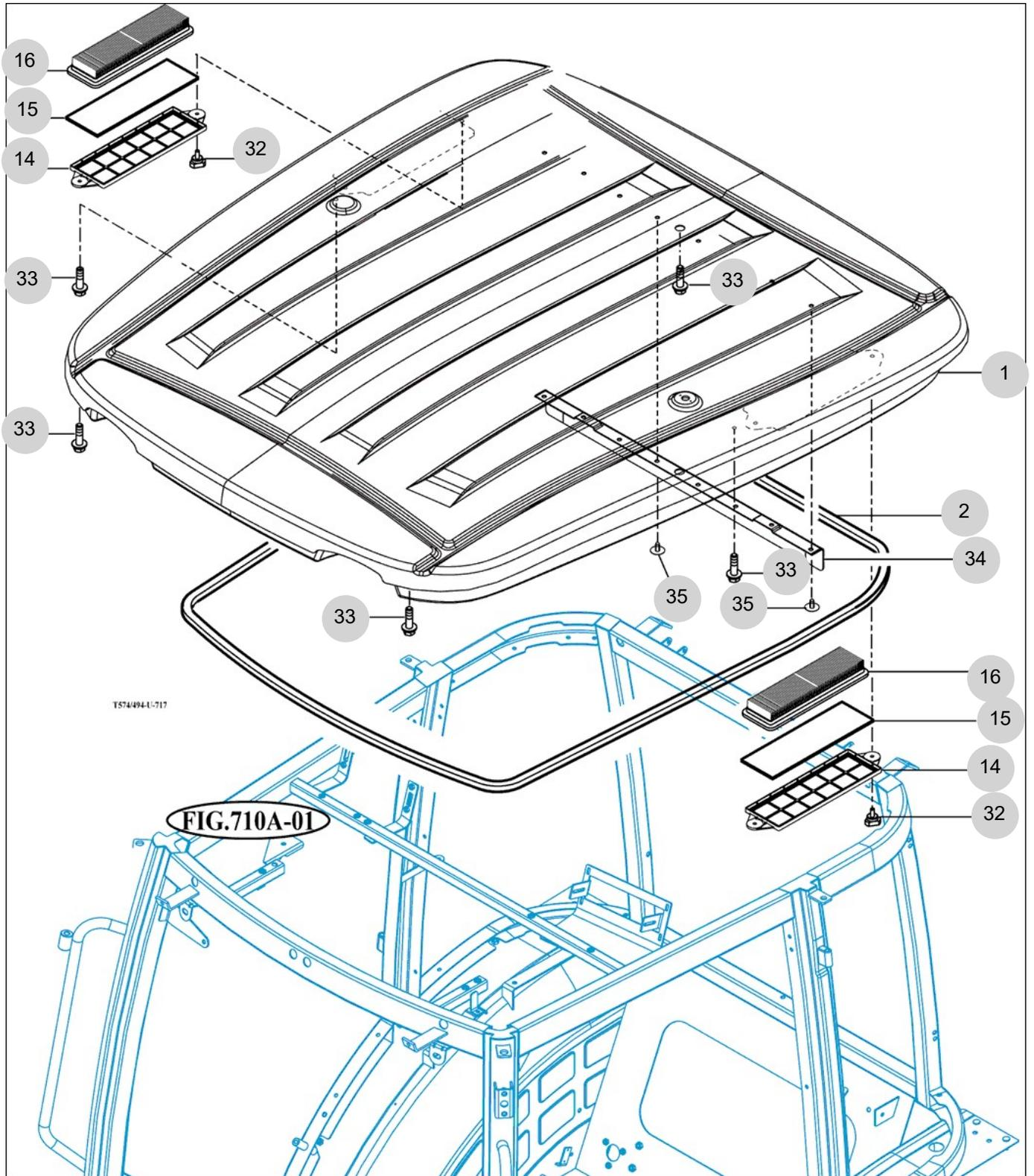

NOTE





FIG 718

CABIN INTERIOR

년/월  
Year/Month

T574ST-B

2022-12

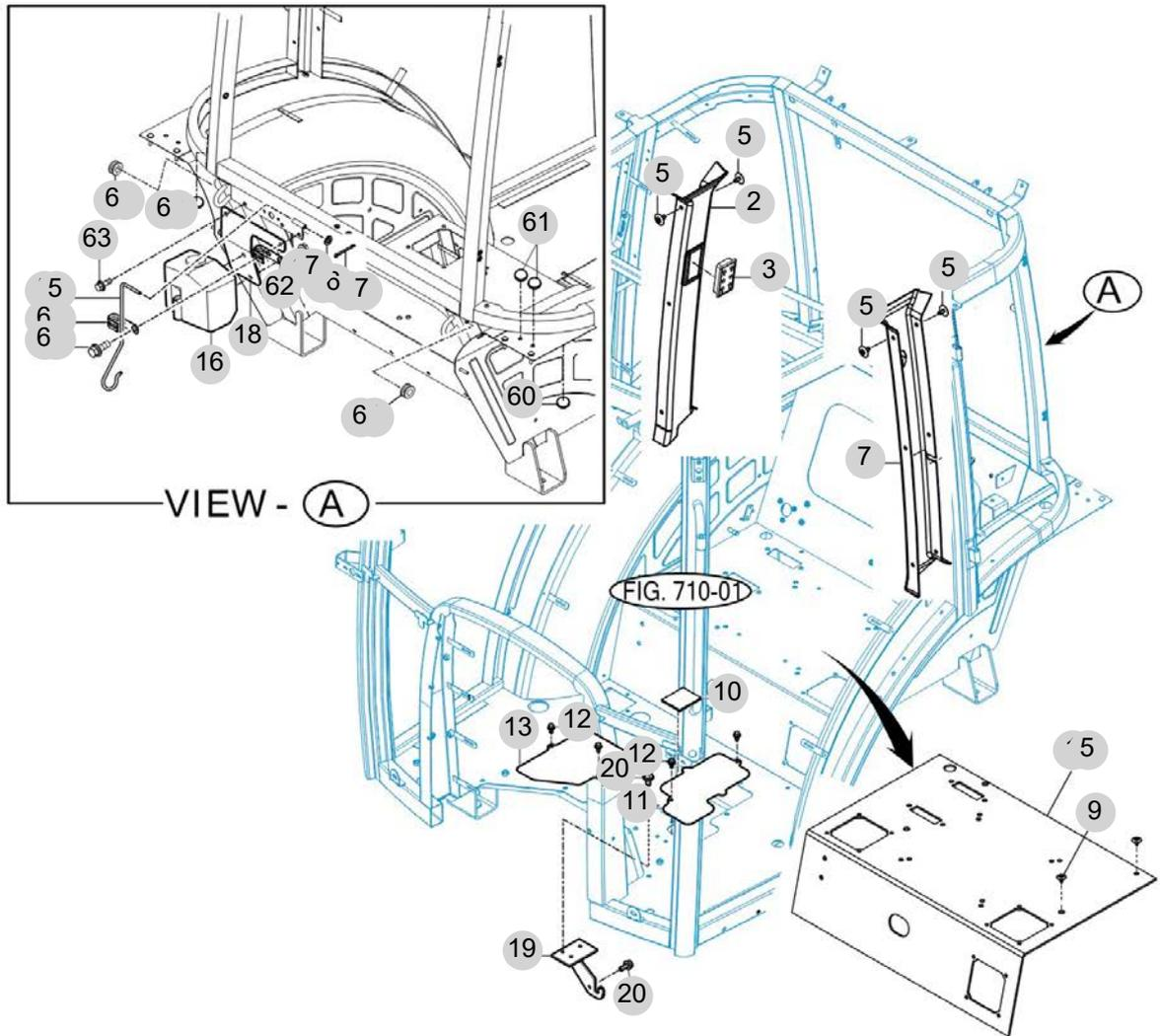

T574ST-B

NOTE



## 8. Electrical System PART NO. T8

FIG 801 BATTERY & MOUNTING	261
FIG 802 HARNESS LAMP	263
FIG 803 INSTRUMENT PANEL	265
FIG 804 ELECTRIC SYSTEM (1)	267
FIG 805A ELECTRIC SYSTEM (2)	269
FIG 806 ELECTRIC SYSTEM (3)	271

FIG 801

T574ST-B

BATTERY & MOUNTING

년/월  
Year/Month

2022-12

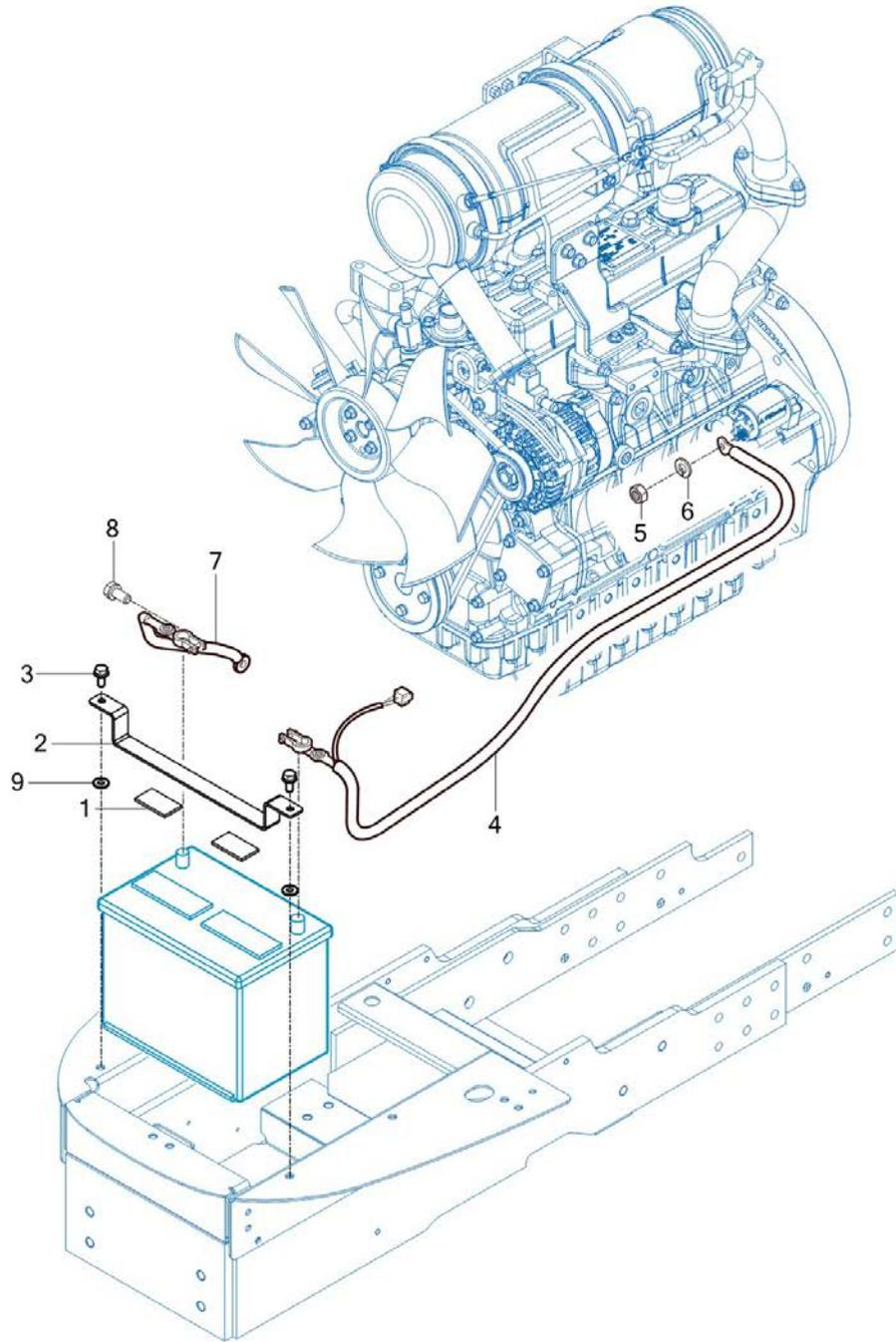

NOTE



FIG 802

T574ST-B

HARNESS LAMP

년/월  
Year/Month

2022-12

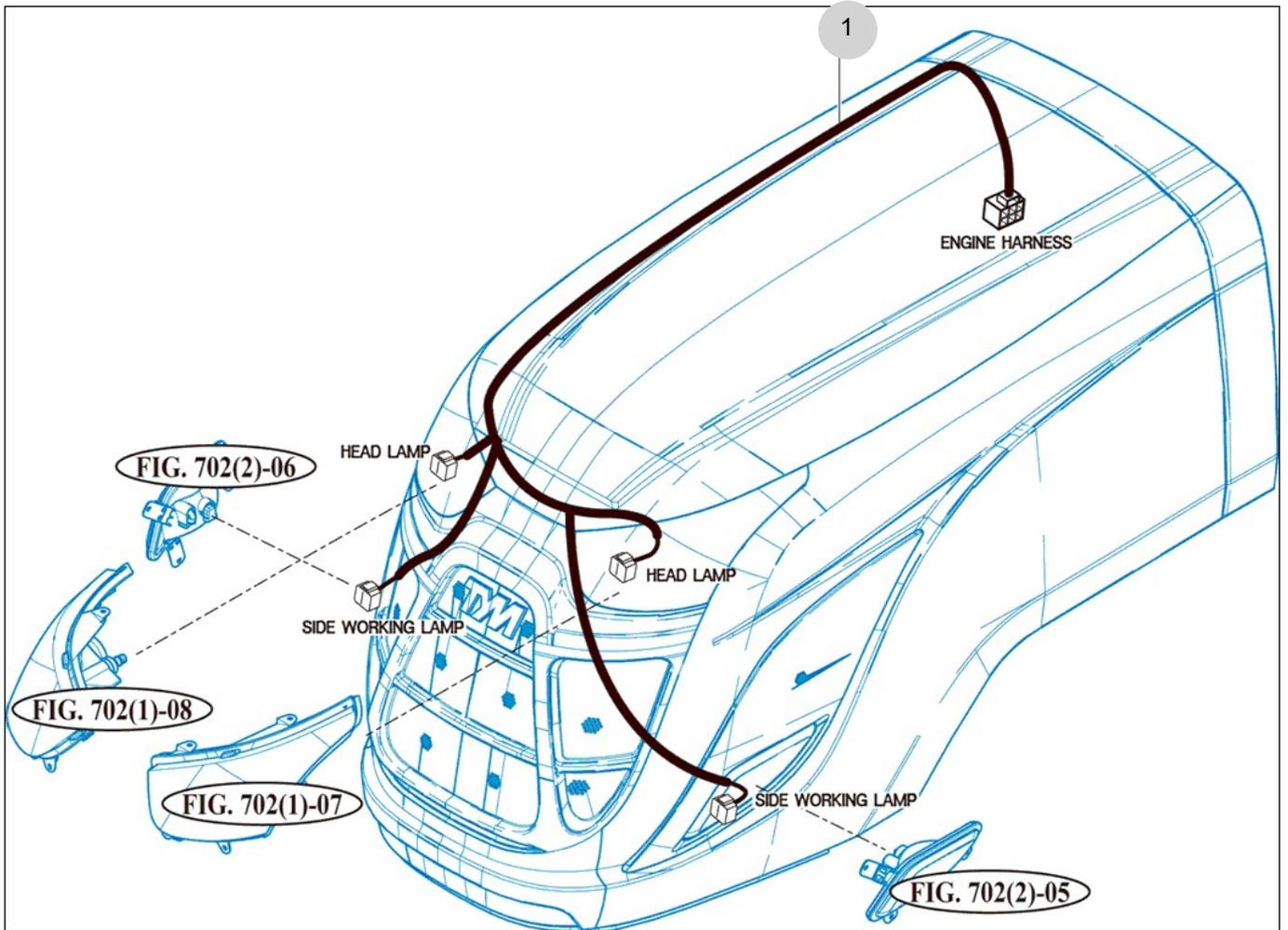

NOTE





FIG 803

INSTRUMENT PANEL

년/월  
Year/Month

T574ST-B

2022-12

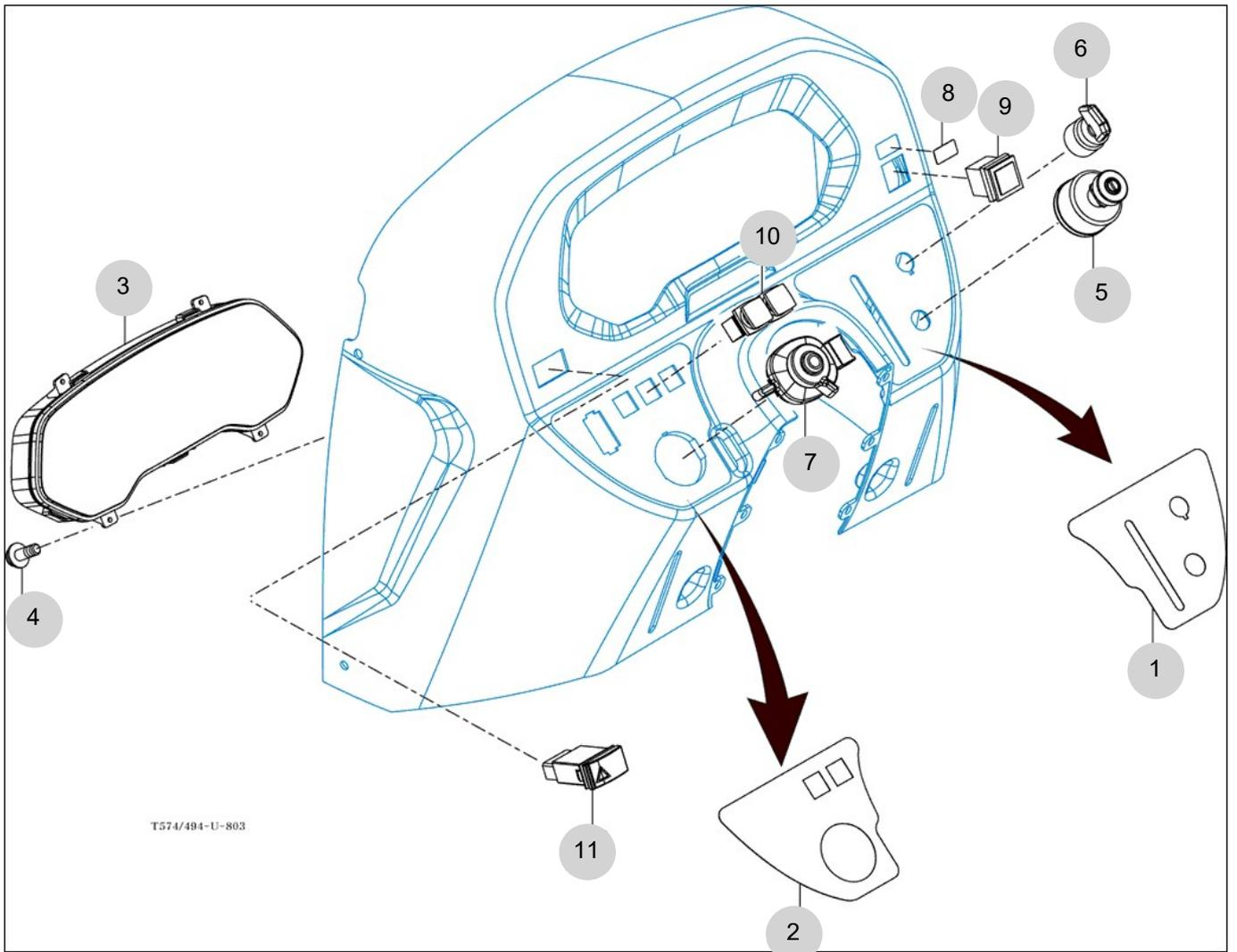

NOTE



FIG 804

T574ST-B

ELECTRIC SYSTEM (1)

년/월  
Year/Month

2022-12

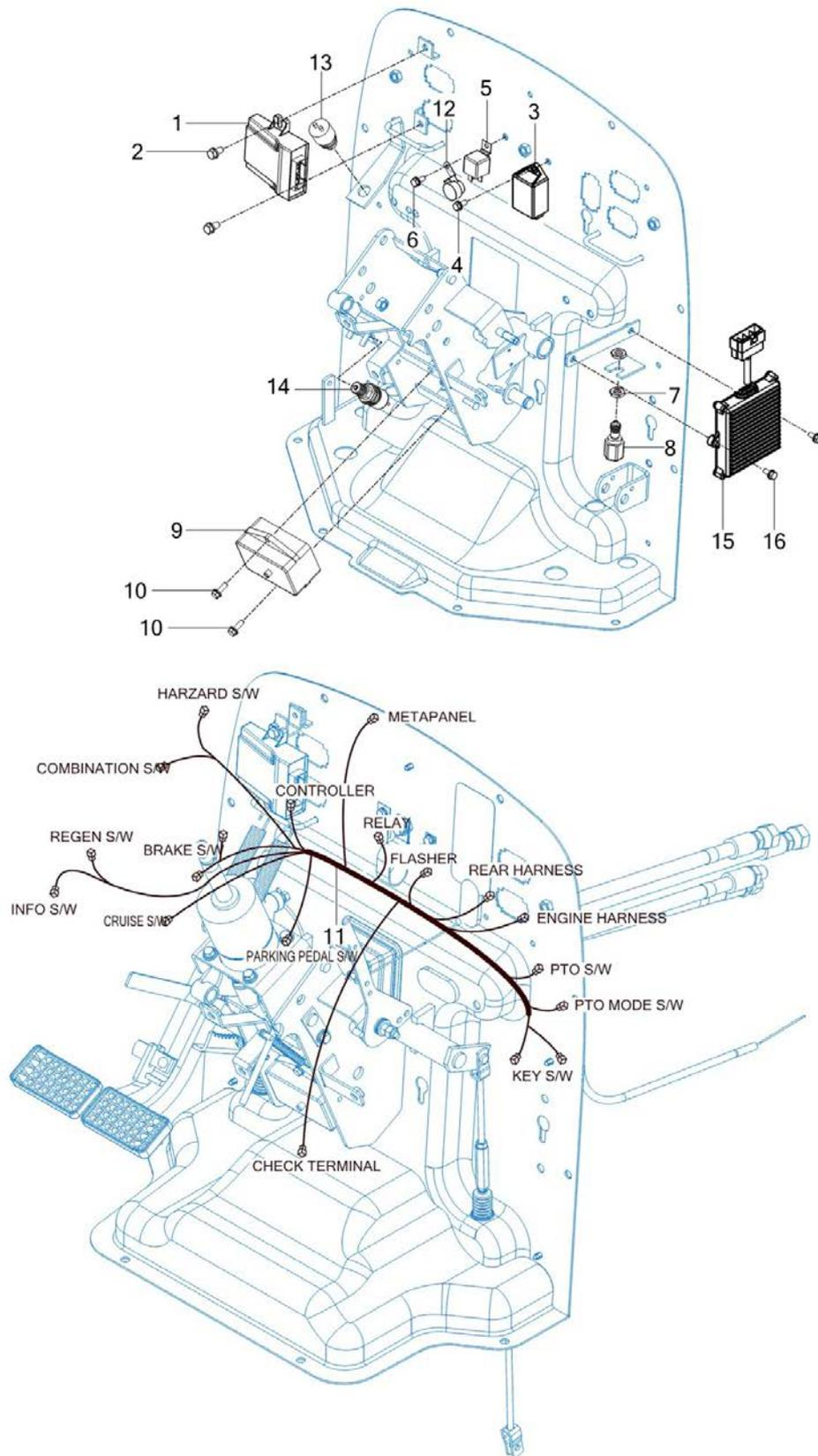

NOTE



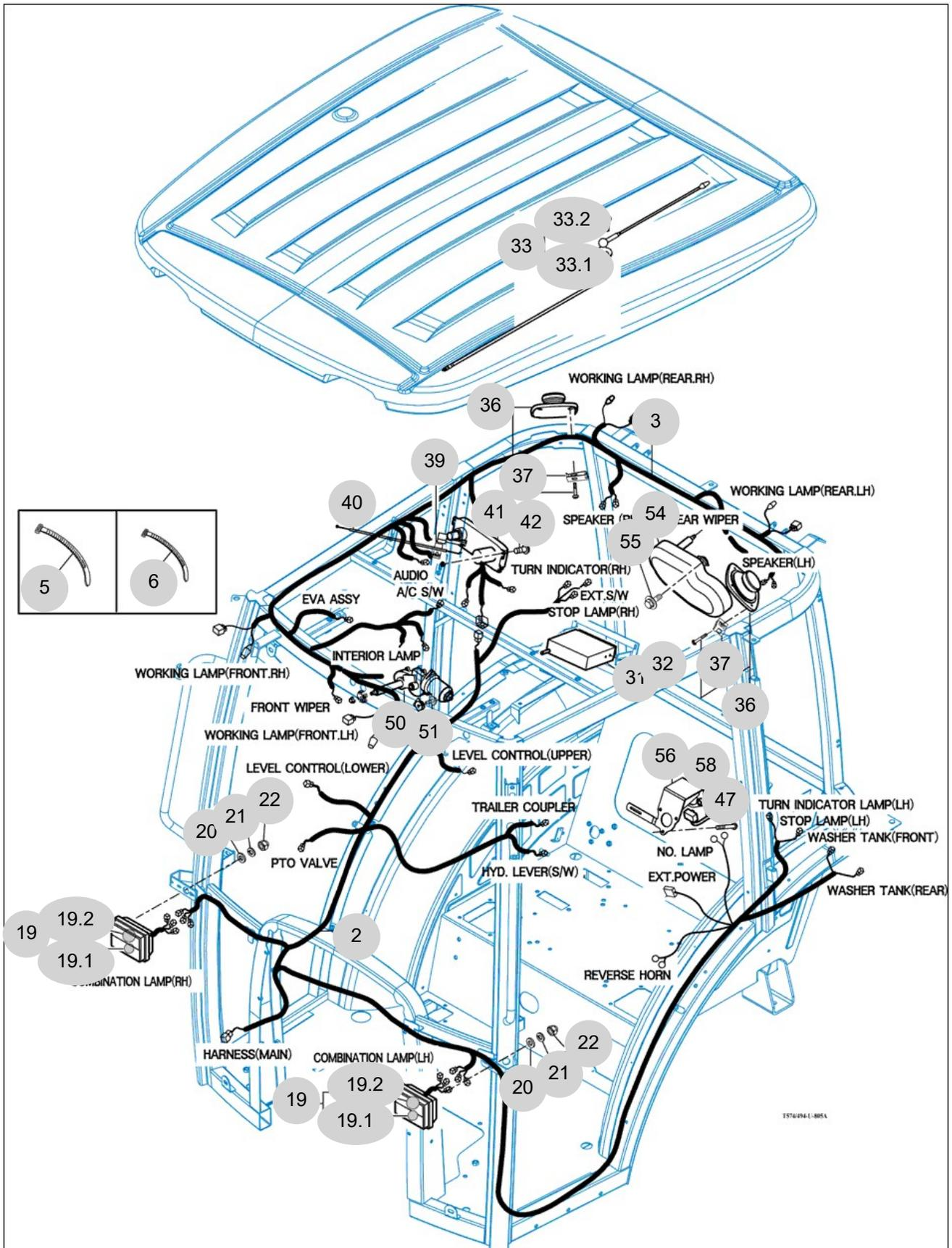

T574ST-B

NOTE



FIG 806

ELECTRIC SYSTEM (3)

년/월  
Year/Month

T574ST-B

2022-12

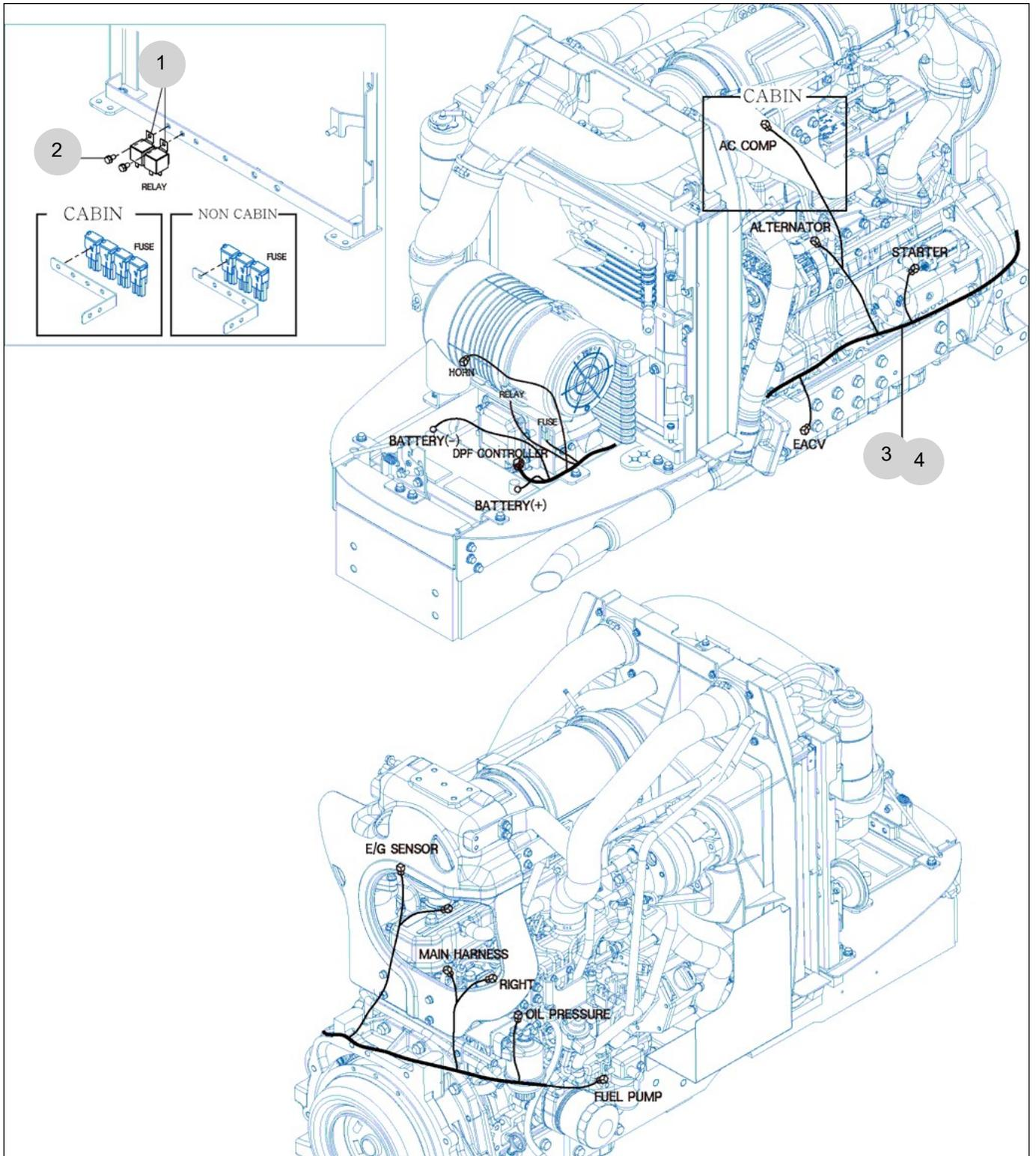

NOTE





## 9. Label/Option PART NO. T9

FIG 901 TOOL & ACCESSORY	274
FIG 902 LABEL	276
FIG 902 LABEL	278
FIG 903 OPTION	280

FIG 901

T574ST-B

TOOL & ACCESSORY

년/월  
Year/Month

2022-12

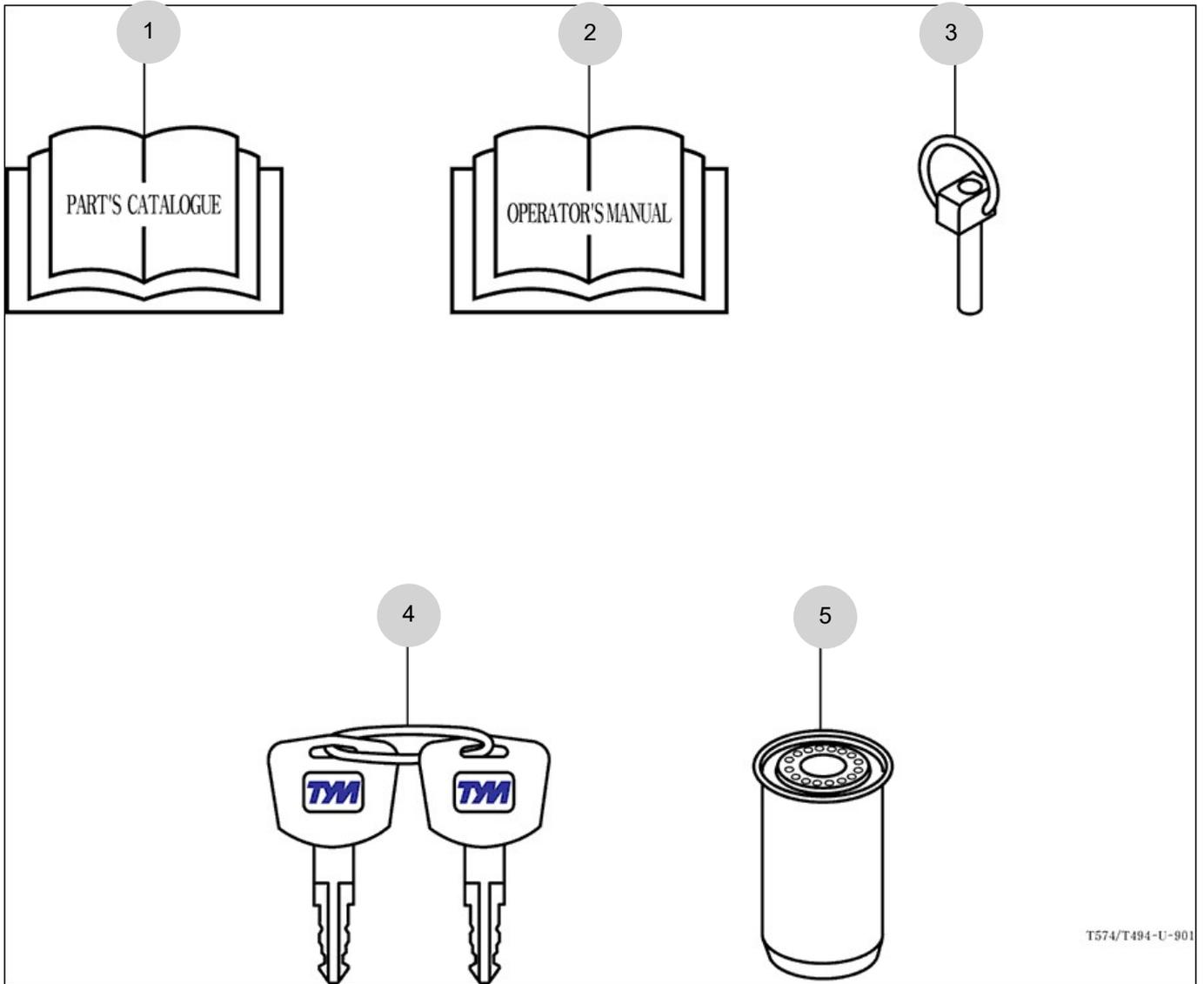

T574/T494-U-901

NOTE



FIG 902

T574ST-B

LABEL

년/월  
Year/Month

2022-12

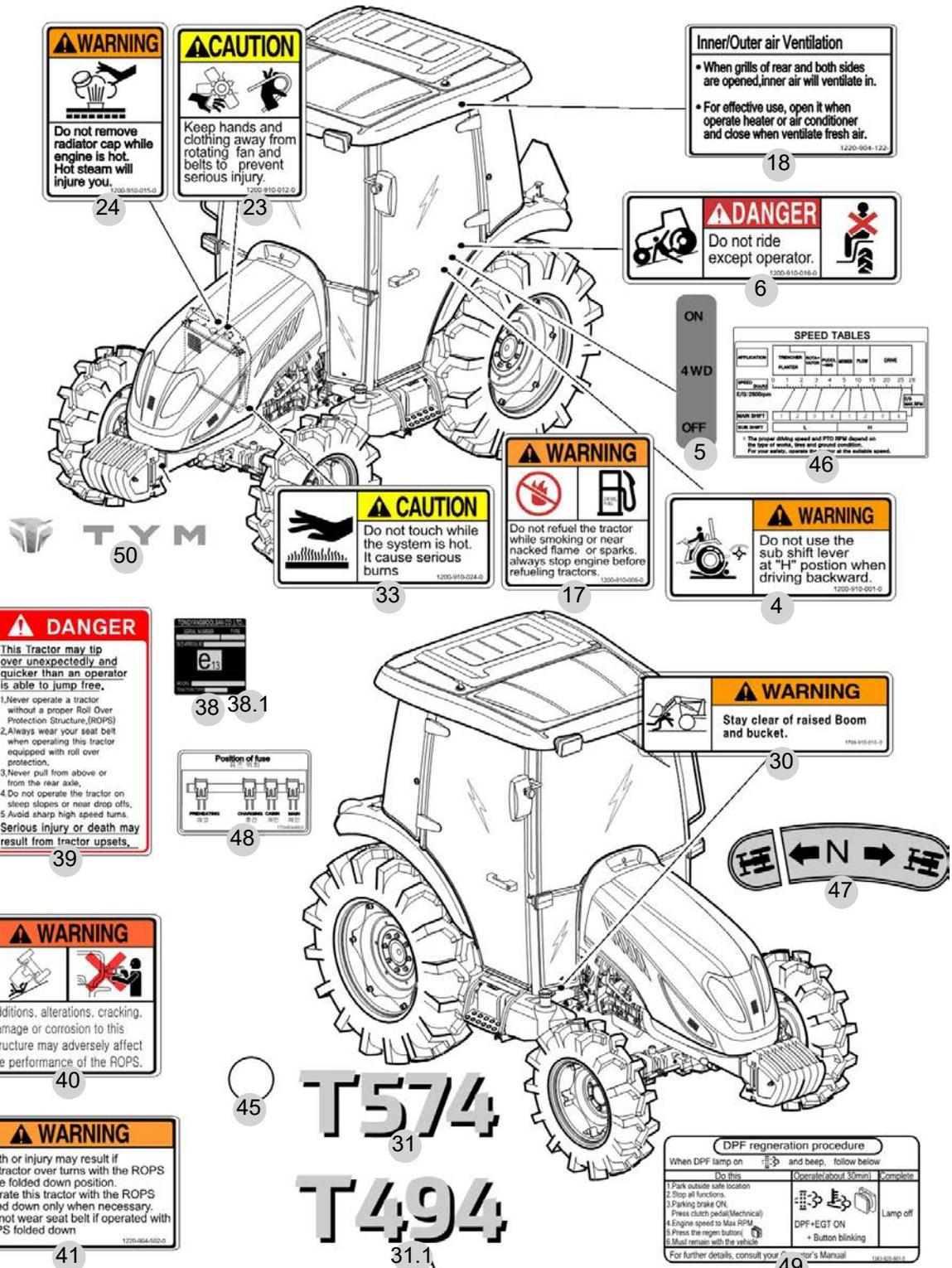

NOTE



FIG 902

LABEL

년/월  
Year/Month

T574ST-B

2022-12

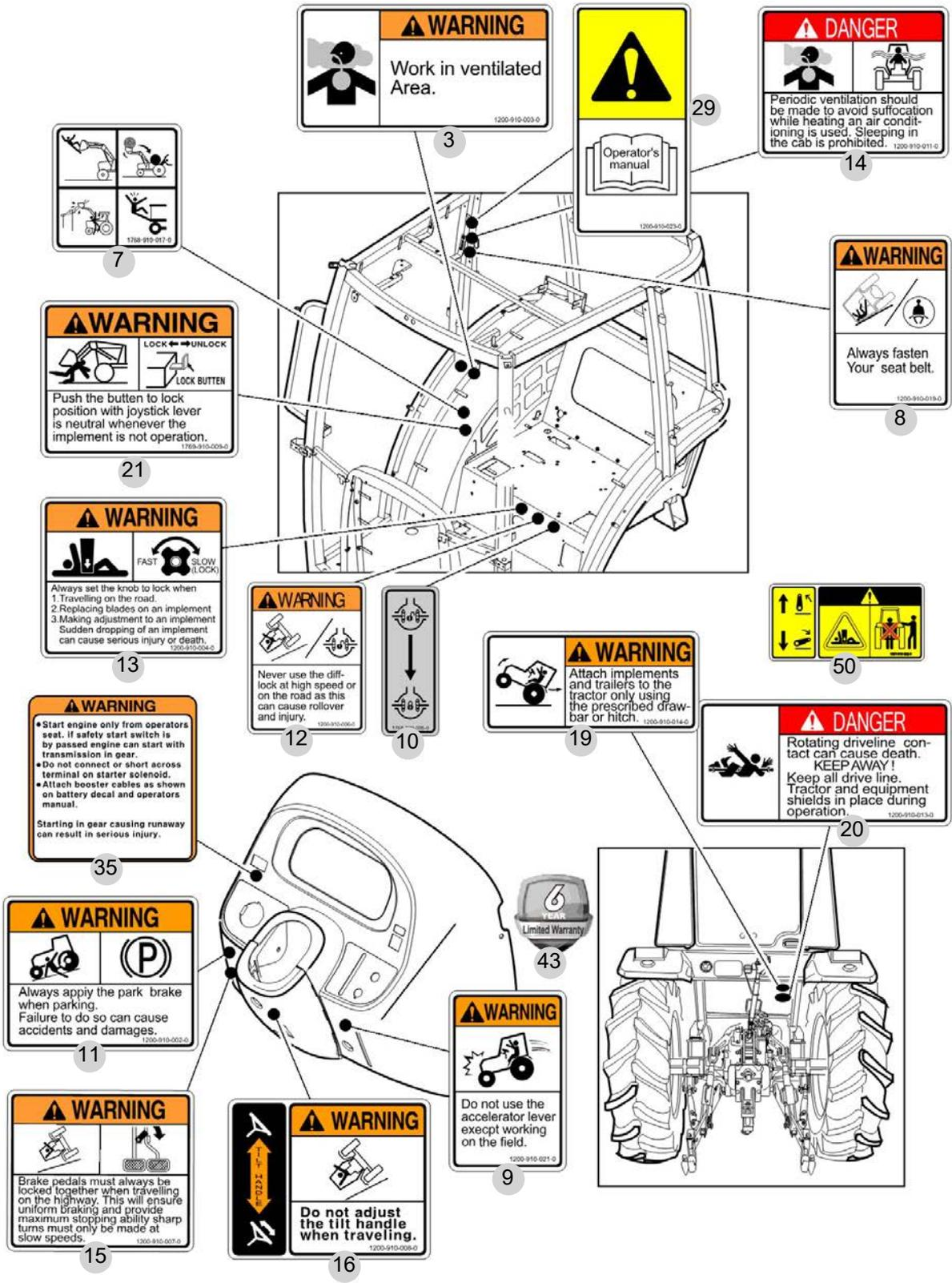

NOTE



FIG 903

OPTION

년/월  
Year/Month

T574ST-B

2022-12

0

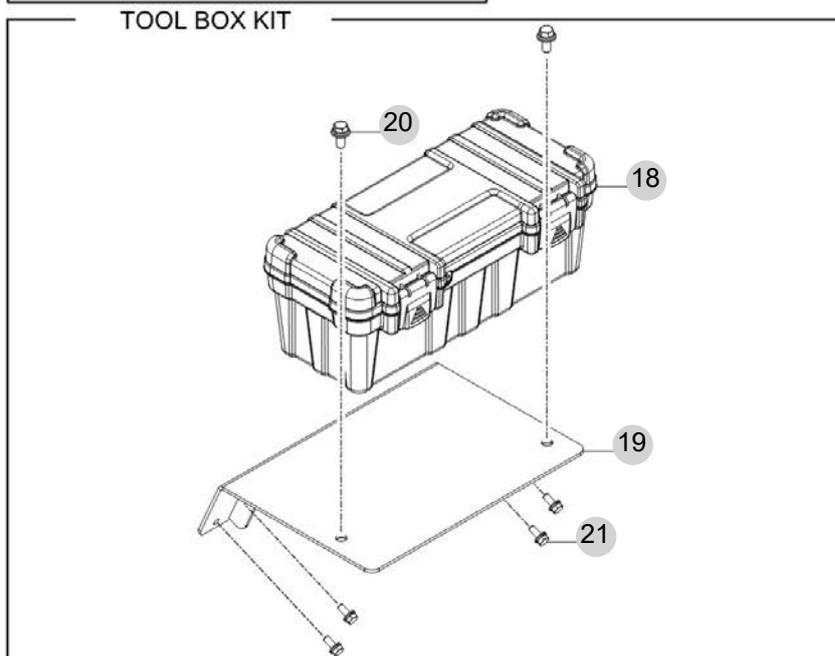
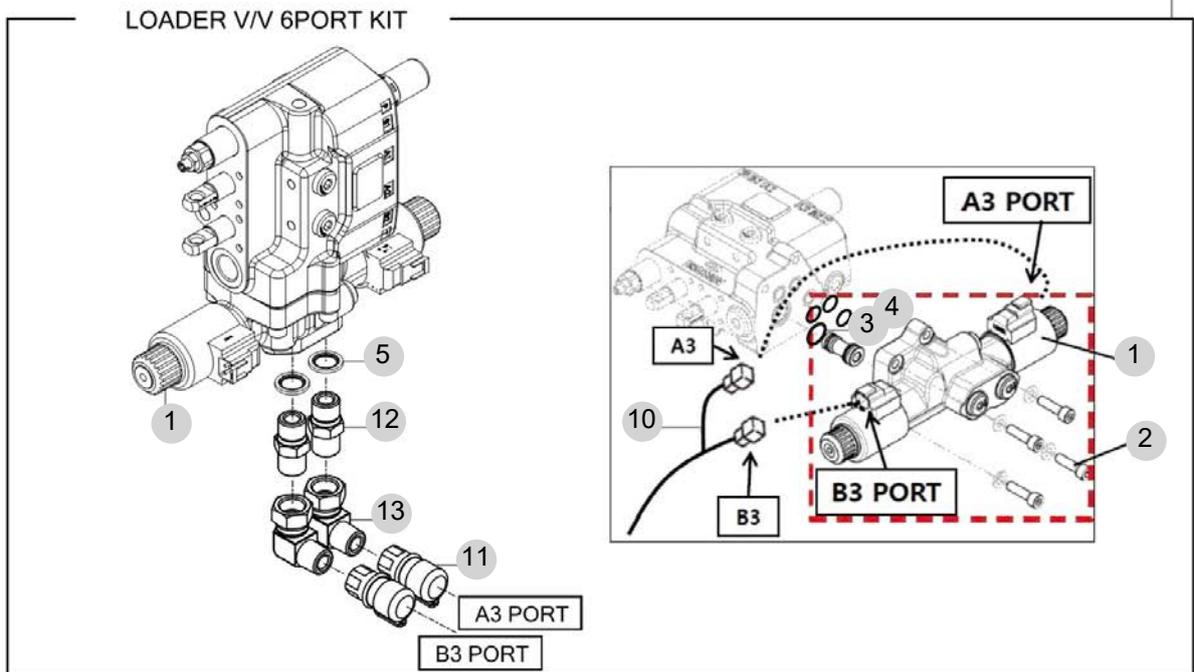

NOTE



