

T494NH

Parts Catalog

목 차

0. TRACTOR KIT PART NO. TK1

FIG 000 TRAILER SOCKET KIT	7
FIG 001 ADAPTER KIT	9

1. Engine PART NO. EG

FIG 100 ENGINE	13
FIG 101 CYLINDER BLOCK	15
FIG 102B OILJET ASS'Y OPTION(T494)	17
FIG 103 CRANK SHAFT	19
FIG 104 PISTON	21
FIG 105 CYLINDER HEAD	23
FIG 106 ROCKER LEVER	25
FIG 107 HEAD COVER	27
FIG 108 GEAR CASE	29
FIG 109 IDLE GEAR	31
FIG 110 CAM SHAFT	33
FIG 111 OIL PUMP	35
FIG 112 HYD. PUMP DRIVE	37
FIG 113 2ND BALANCE	39
FIG 114 OIL PAN	41
FIG 115B INTAKE MANIFOLD(T494)	43
FIG 116B EXHAUST MANIFOLD(T494)	45
FIG 117B TURBOCHARGER ASS'Y(T494)	47
FIG 118B TURBOCHARGER PLUMBING OPTION(T494)	49
FIG 119B BREATHER(T494)	51
FIG 120 FUEL INJECTION PUMP	53
FIG 121 FUEL INJECTION VALVE	55
FIG 122 FUEL PIPE ASS'Y	57
FIG 123 OIL FILTER	59
FIG 124 OIL COOLER	61
FIG 125 OIL GAUGUE	63

FIG 126 OIL FILLER CAP	65
FIG 127 COOLING WATER PUMP	67
FIG 128 CRANK SHAFT PULLEY	69
FIG 129 V-PULLEY	71
FIG 130 COOLING FAN	73
FIG 131 FLYWHEEL HOUSING	75
FIG 132 FLYWHEEL	77
FIG 133 GLOW PLUG ASS'Y OPTION	79
FIG 134 STARTING MOTOR	81
FIG 135 FUEL FILTER BRACKET ASS'Y	83
FIG 136 ALTERNATOR	85
FIG 137 V-BELT	87
FIG 138 FUEL FILTER	89
FIG 139B DPF SUPPORT (T494)	91
FIG 140 DATAPLATE	93
FIG 142B DPF ASS'Y (T494)	95
FIG 143 LIFT ASS'Y	97
FIG 144 COMP . DRIVE PULLEY ASS'Y OPTION	99
FIG 147 LOOSED PARTS	101

2. Engine Accessories PART NO. T2

FIG 201B AIR CLEANER (T494)	104
FIG 202 RADIATOR	106
FIG 203 MUFFLER	108
FIG 204 FUEL HOSE & FILTER	110
FIG 205 FUEL TANK	112
FIG 206 ACCELERATOR	114
FIG 207 OIL COOLER	116

3. Clutch/Brake/Steering PART NO. T3

FIG 301 FLYWHEEL HOUSING	119
FIG 302 CLUTCH PEDAL	121
FIG 303 BRAKE	123
FIG 304 BRAKE PEDAL & LINK	125
FIG 305 FRONT WHEEL	127
FIG 306 REAR WHEEL	129

FIG 307 POWER STEERING WHEEL	131
FIG 308 POWER STEERING VALVE	133
FIG 309 POWER STEERING CYLINDER	135
FIG 310 HST CONTROL LINK	137

4. Transmission PART NO. T4

FIG 401 TRANSMISSION FRONT CASE	141
FIG 402 HST	143
FIG 403 MID TRANSMISSION CASE	145
FIG 404 TRANSFER GEAR SET	147
FIG 405 TRANSMISSION REAR CASE	149
FIG 406 SUB CHANGE GEARS	151
FIG 407 SUB CHANGE SHIFTER	153
FIG 408 DRIVE GEARS	155
FIG 409 4WD CHANGE LEVER	157
FIG 410 P.T.O DRIVE SHAFT	159
FIG 411 P.T.O CHANGE GEARS	161
FIG 412 REAR DIFFERENTIAL GEARS	163
FIG 413 REAR AXLE HOUSING	166

5. Front Axle PART NO. T5

FIG 501 FRONT AXLE SUPPORT	169
FIG 502 FRONT DRIVE SHAFT	171
FIG 503 FRONT AXLE HOUSING	173
FIG 504 FRONT DIFFERENTIAL GEARS	175
FIG 505 FRONT GEAR CASE (1)	177
FIG 506 FRONT GEAR CASE (2)	179
FIG 507 FRONT GEAR CASE (3)	181

6. Hydraulic/3P-Link PART NO. T6

FIG 601 CYLINDER CASE	184
FIG 602 LIFT ARM	186
FIG 603 CYLINDER	188
FIG 604 POSITION LINK	190
FIG 605 CONTROL VALVE	192

FIG 606 DRAFT LINK	194
FIG 607 POSITION & DRAFT LEVER	196
FIG 607-2 POSITION & DRAFT LEVER(2)	198
FIG 608 EXTERIOR HYD. VALVE	200
FIG 609 HYDRAULIC PIPE	202
FIG 610 JOYSTICK	204
FIG 612 HITCH & 3-POINT LINK	207
FIG 613 LOWER LINK & LIFT ROD	210

7. Sheet Metal & Cabin PART NO. T7

FIG 701 BONNET FRAME	213
FIG 702 BONNET (1)	215
FIG 702-2 BONNET (2)	217
FIG 703 EXTENSION COVER	219
FIG 704-2 LEVER COVER & STEP-NON CAB	221
FIG 705 FRONT & REAR MOUNTING	223
FIG 706 SEAT & MAT	225
FIG 710-2 FRAME & 2POLES-ROPS-NON CAB	227
FIG 713-2 SUB FENDER & COVER-NON CAB	229
FIG 714-2 MIRROR&WORKING LAMP-NON CAB	231

8. Electrical System PART NO. T8

FIG 801 BATTERY & MOUNTING	234
FIG 802 HARNESS LAMP	236
FIG 803 INSTRUMENT PANEL	238
FIG 804 ELECTRIC SYSTEM (1)	240
FIG 805-2 ELECTRIC SYSTEM (2)-NON CAB	242
FIG 806 ELECTRIC SYSTEM (3)	244

9. Label/Option PART NO. T9

FIG 901 TOOL & ACCESSORY	247
FIG 902 LABEL	249
FIG 902-2 LABEL	251

0. TRACTOR KIT PART NO. TK1

FIG 000 TRAILER SOCKET KIT

7

FIG 001 ADAPTER KIT

9

FIG 000 T494NH	TRAILER SOCKET KIT	년/월 Year/Month 2022-12
-------------------	--------------------	------------------------------

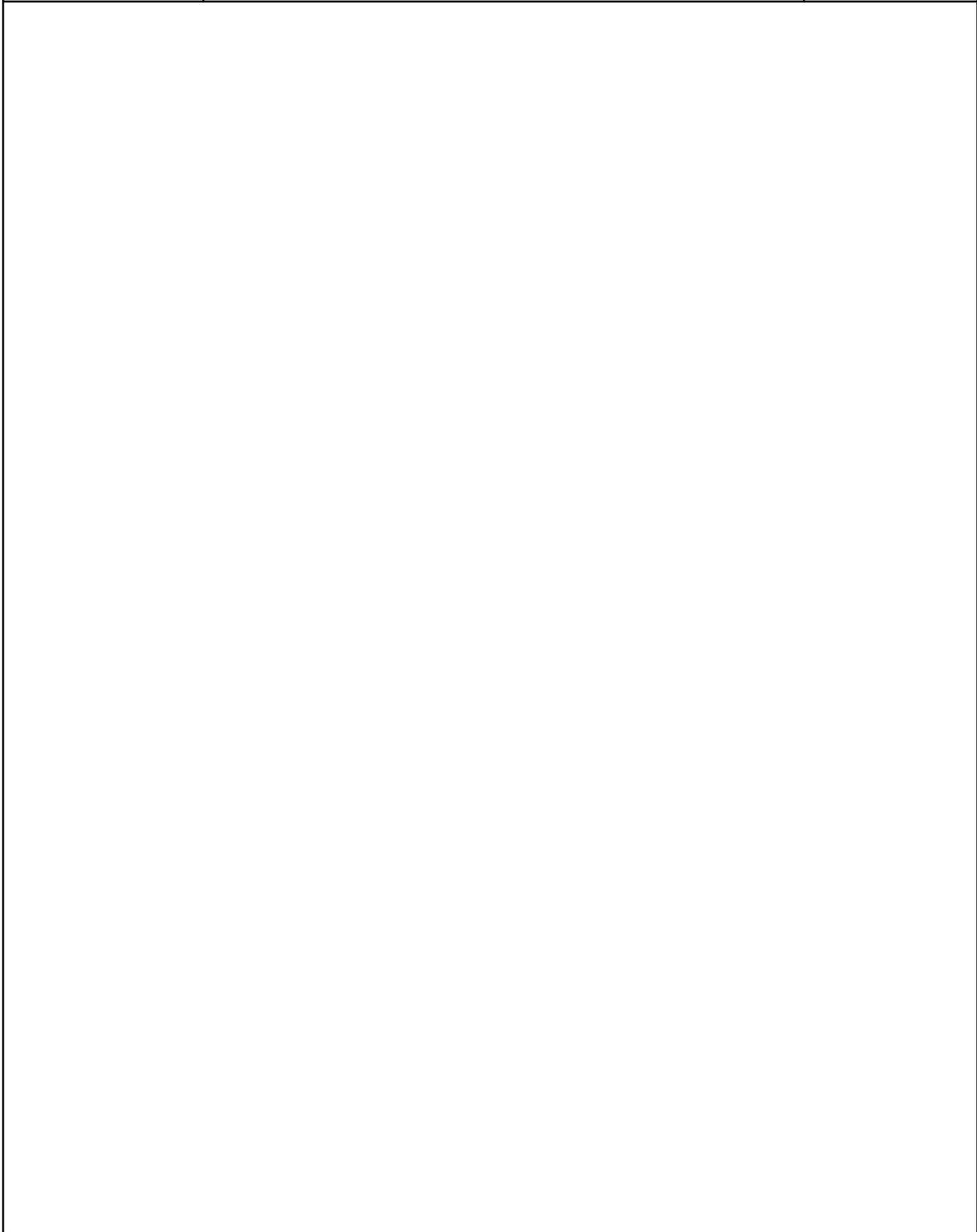

NOTE	
------	--

FIG 001 T494NH	ADAPTER KIT	년/월 Year/Month 2022-12
-------------------	-------------	------------------------------



NOTE	
------	--

1. Engine PART NO. EG

FIG 100 ENGINE	13
FIG 101 CYLINDER BLOCK	15
FIG 102B OILJET ASS'Y OPTION(T494)	17
FIG 103 CRANK SHAFT	19
FIG 104 PISTON	21
FIG 105 CYLINDER HEAD	23
FIG 106 ROCKER LEVER	25
FIG 107 HEAD COVER	27
FIG 108 GEAR CASE	29
FIG 109 IDLE GEAR	31
FIG 110 CAM SHAFT	33
FIG 111 OIL PUMP	35
FIG 112 HYD. PUMP DRIVE	37
FIG 113 2ND BALANCE	39
FIG 114 OIL PAN	41
FIG 115B INTAKE MANIFOLD(T494)	43
FIG 116B EXHAUST MANIFOLD(T494)	45
FIG 117B TURBOCHARGER ASS'Y(T494)	47
FIG 118B TURBOCHARGER PLUMBING OPTION(T494)	49
FIG 119B BREATHER(T494)	51
FIG 120 FUEL INJECTION PUMP	53
FIG 121 FUEL INJECTION VALVE	55
FIG 122 FUEL PIPE ASS'Y	57
FIG 123 OIL FILTER	59
FIG 124 OIL COOLER	61
FIG 125 OIL GAUGUE	63
FIG 126 OIL FILLER CAP	65
FIG 127 COOLING WATER PUMP	67
FIG 128 CRANK SHAFT PULLEY	69
FIG 129 V-PULLEY	71
FIG 130 COOLING FAN	73
FIG 131 FLYWHEEL HOUSING	75
FIG 132 FLYWHEEL	77
FIG 133 GLOW PLUG ASS'Y OPTION	79
FIG 134 STARTING MOTOR	81
FIG 135 FUEL FILTER BRACKET ASS'Y	83
FIG 136 ALTERNATOR	85
FIG 137 V-BELT	87

FIG 138 FUEL FILTER	89
FIG 139B DPF SUPPORT (T494)	91
FIG 140 DATAPLATE	93
FIG 142B DPF ASS'Y (T494)	95
FIG 143 LIFT ASS'Y	97
FIG 144 COMP . DRIVE PULLEY ASS'Y OPTION	99
FIG 147 LOOSED PARTS	101

FIG 100 T494NH	ENGINE	년/월 Year/Month
		2022-12
NOTE		

FIG 101

CYLINDER BLOCK

년/월
Year/Month

2022-12

T494NH

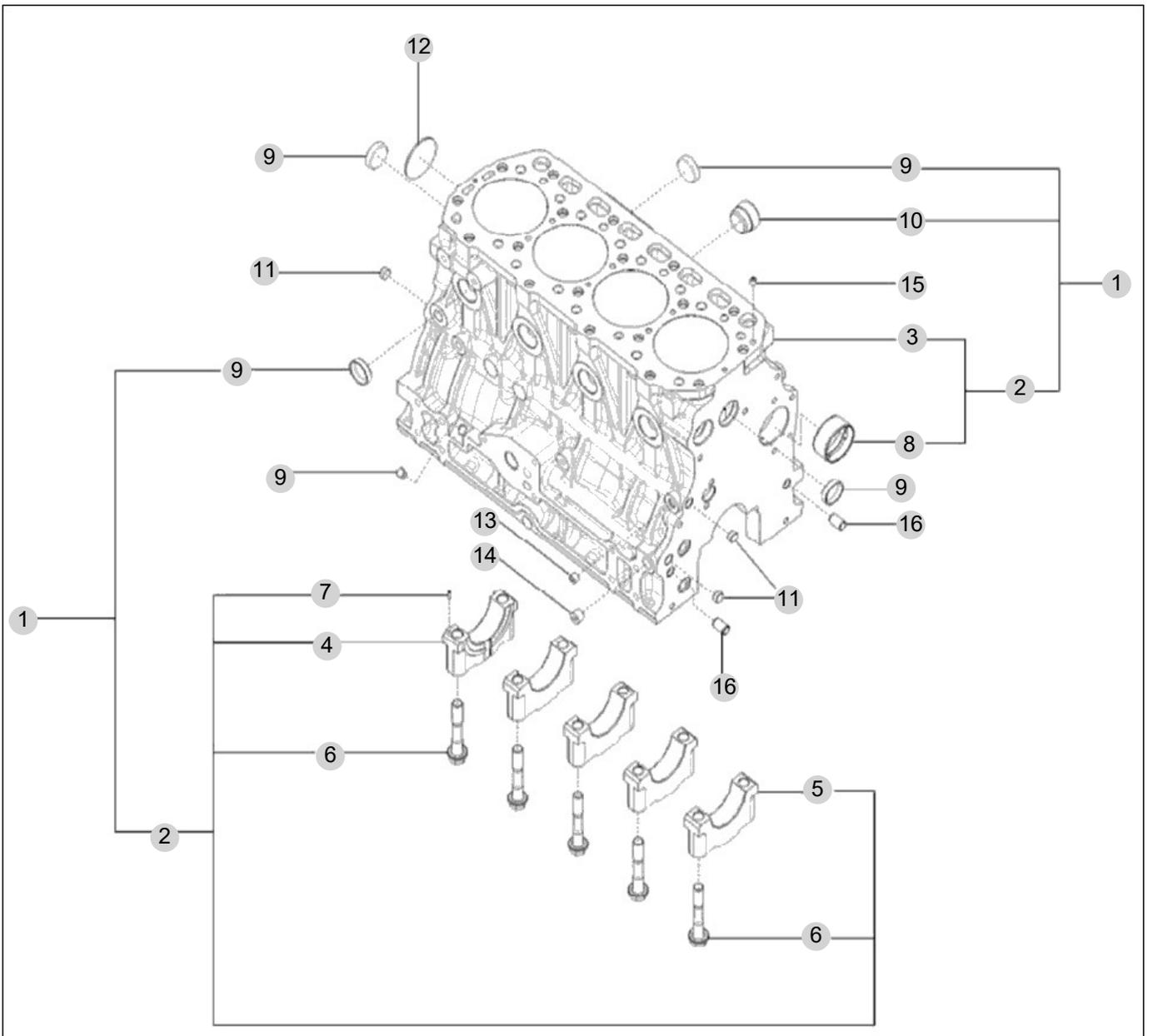

NOTE

FIG 102B

OILJET ASS'Y OPTION(T494)

년/월
Year/Month

2022-12

T494NH

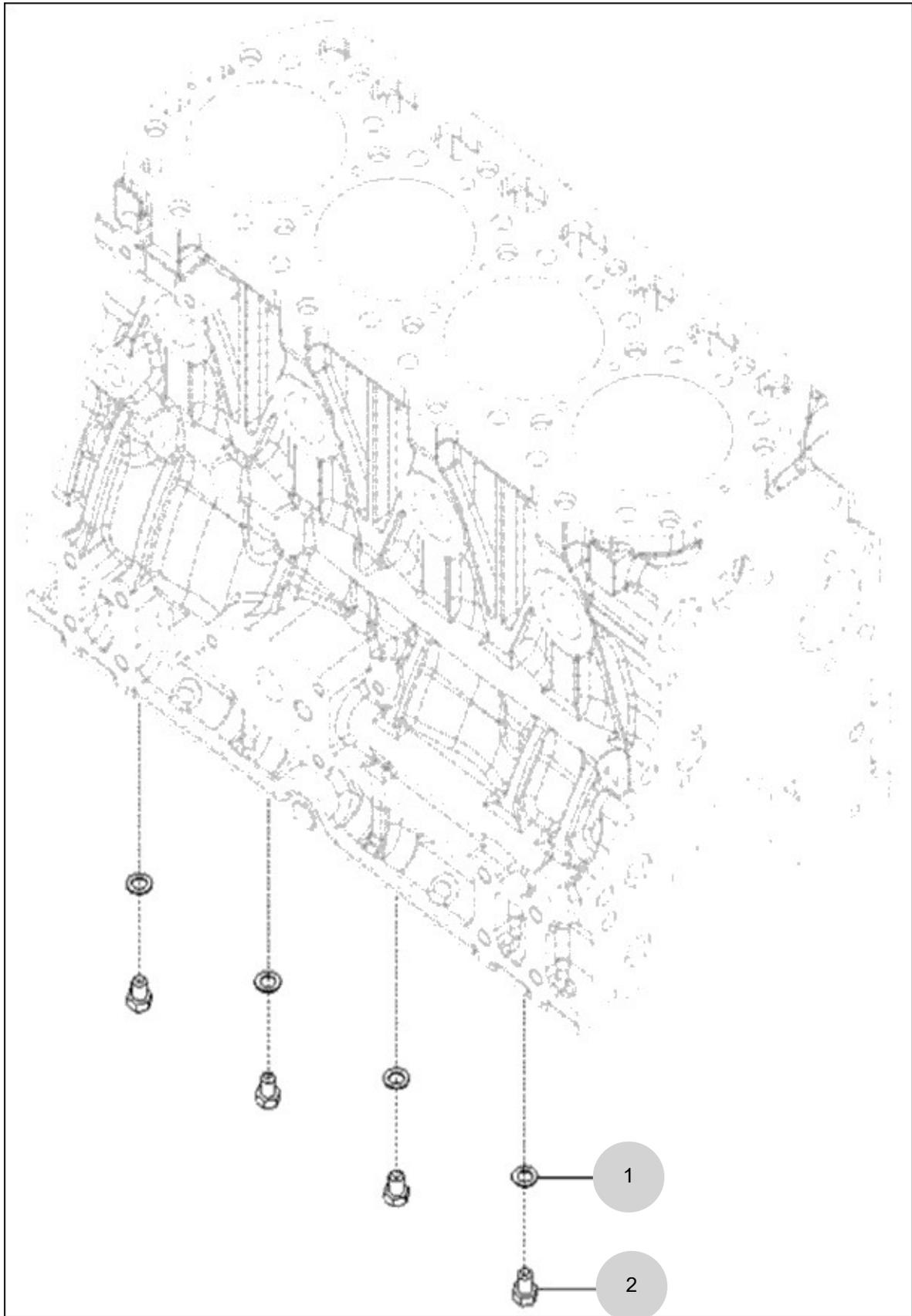

NOTE

FIG 103

CRANK SHAFT

년/월
Year/Month

2022-12

T494NH

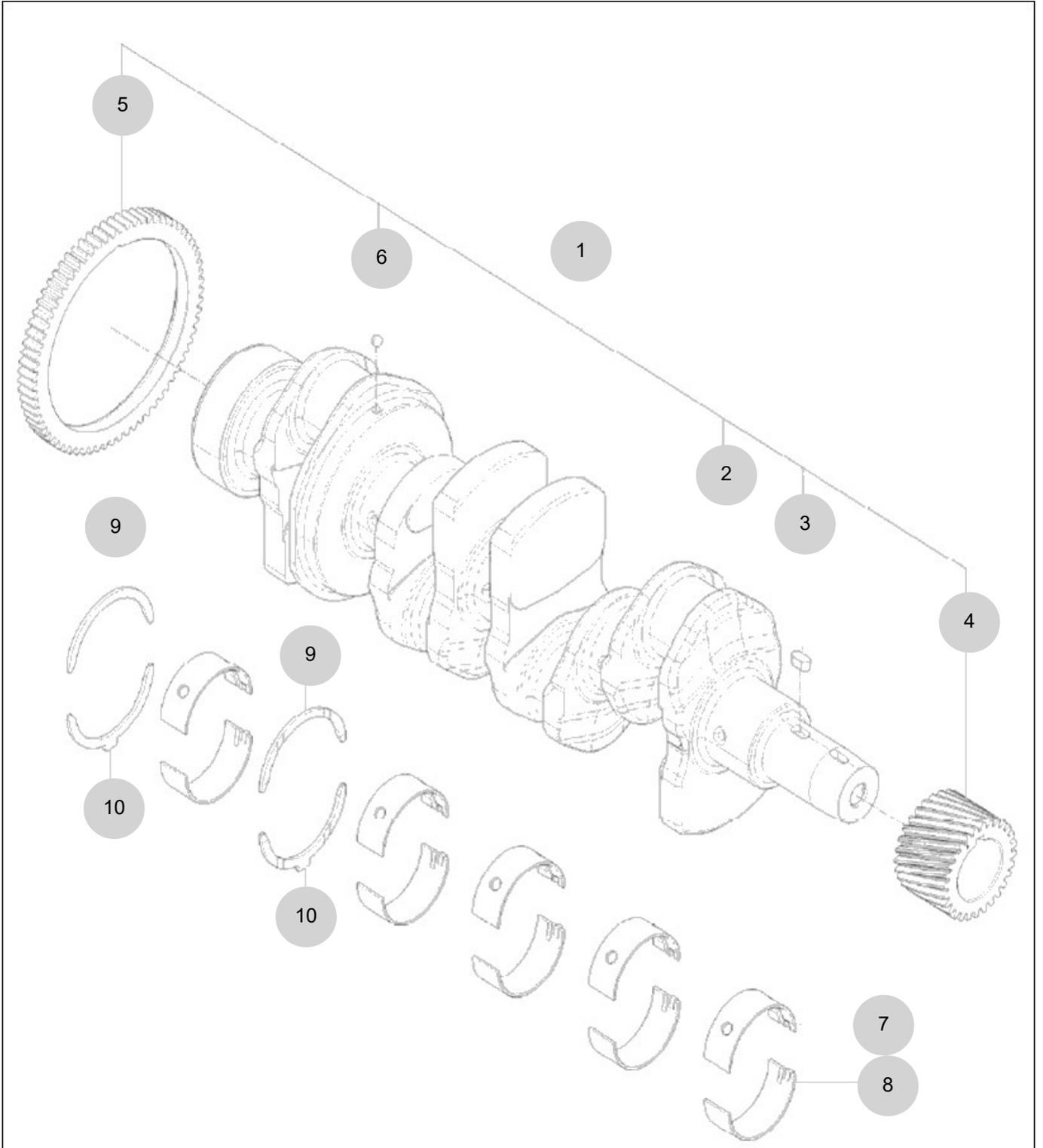

NOTE

FIG 104

T494NH

PISTON

년/월
Year/Month

2022-12

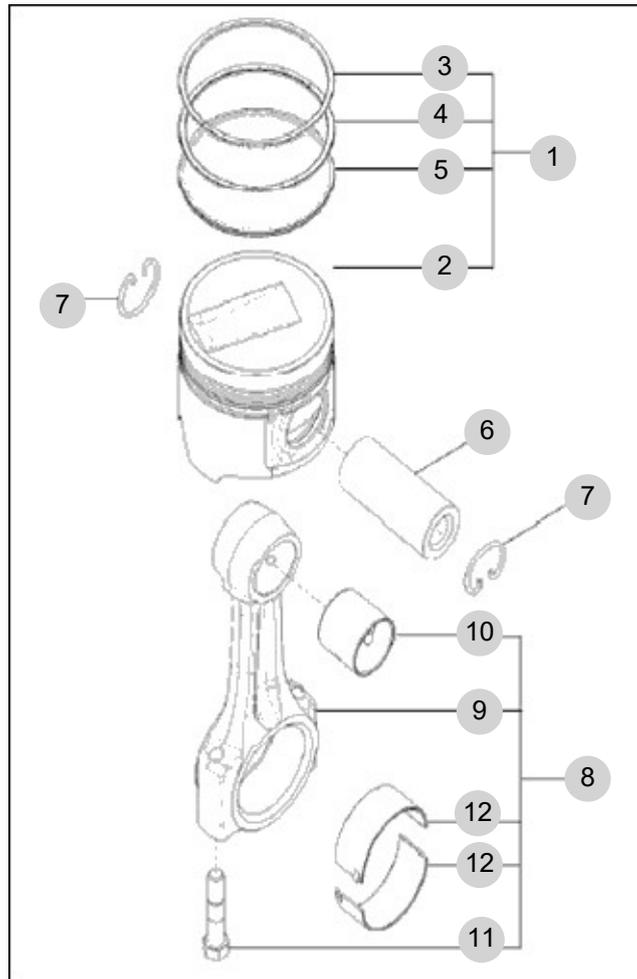

NOTE

FIG 105

CYLINDER HEAD

년/월
Year/Month

2022-12

T494NH

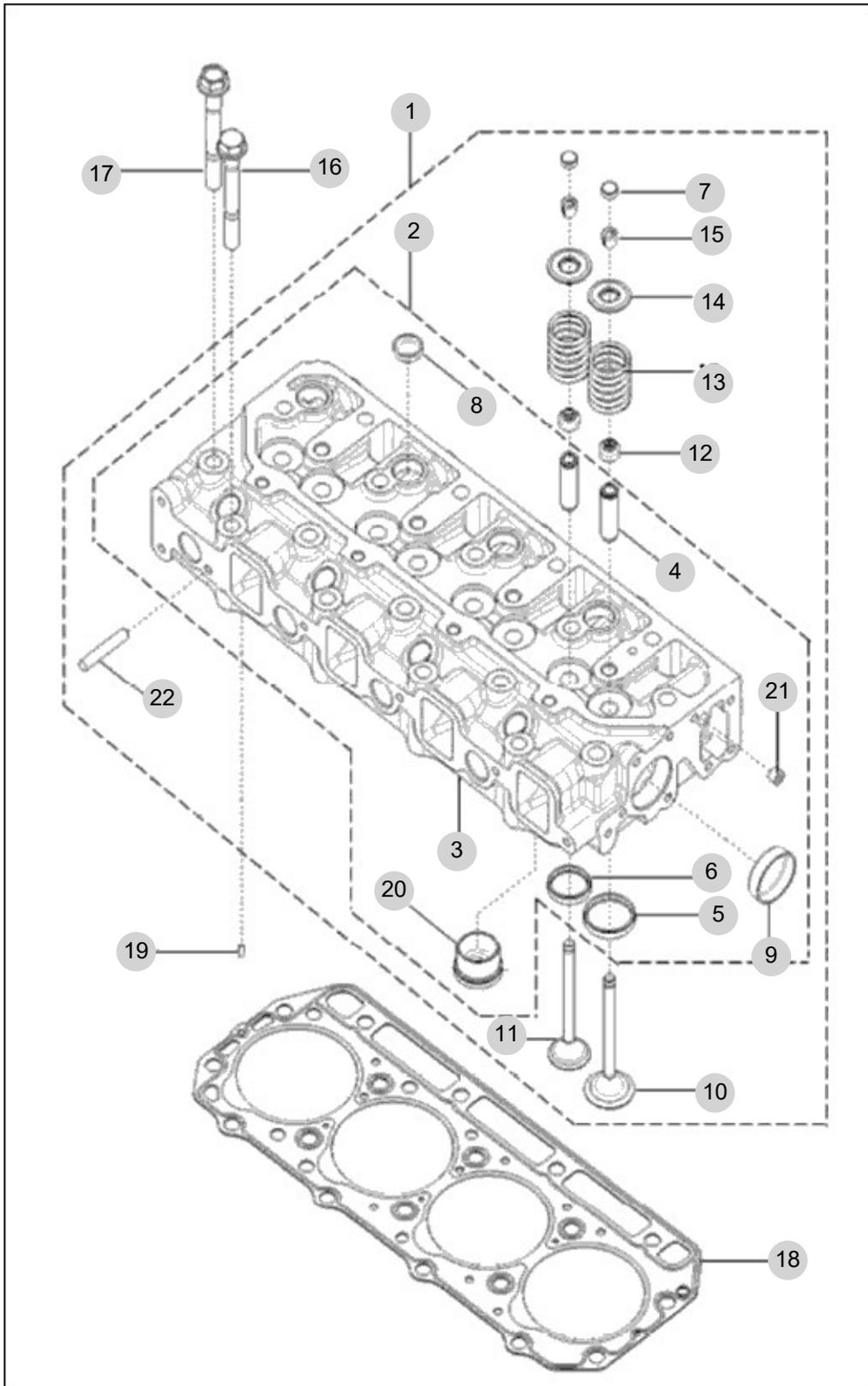

NOTE

FIG 106

ROCKER LEVER

년/월
Year/Month

2022-12

T494NH

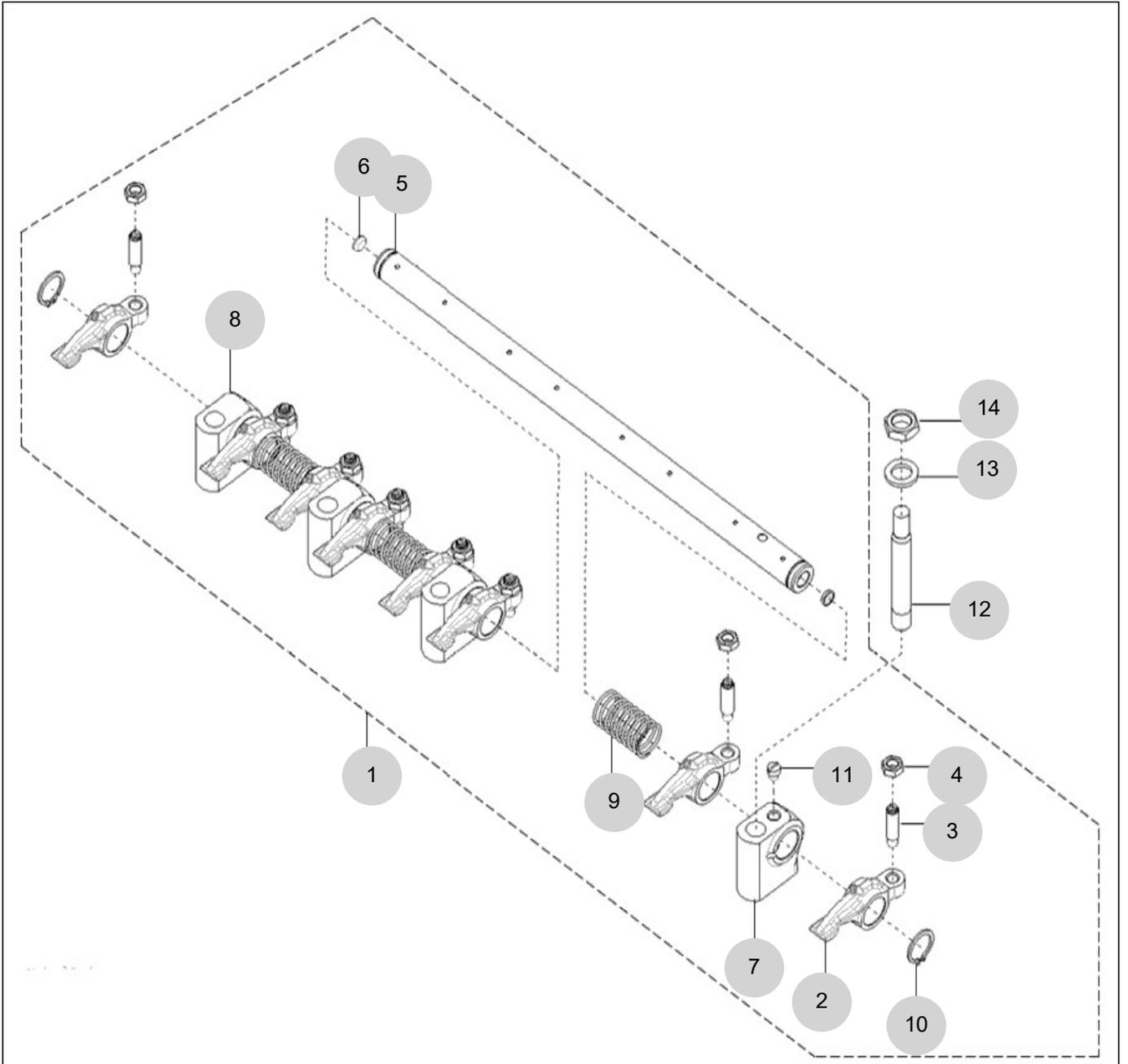

NOTE

FIG 107

T494NH

HEAD COVER

년/월
Year/Month

2022-12

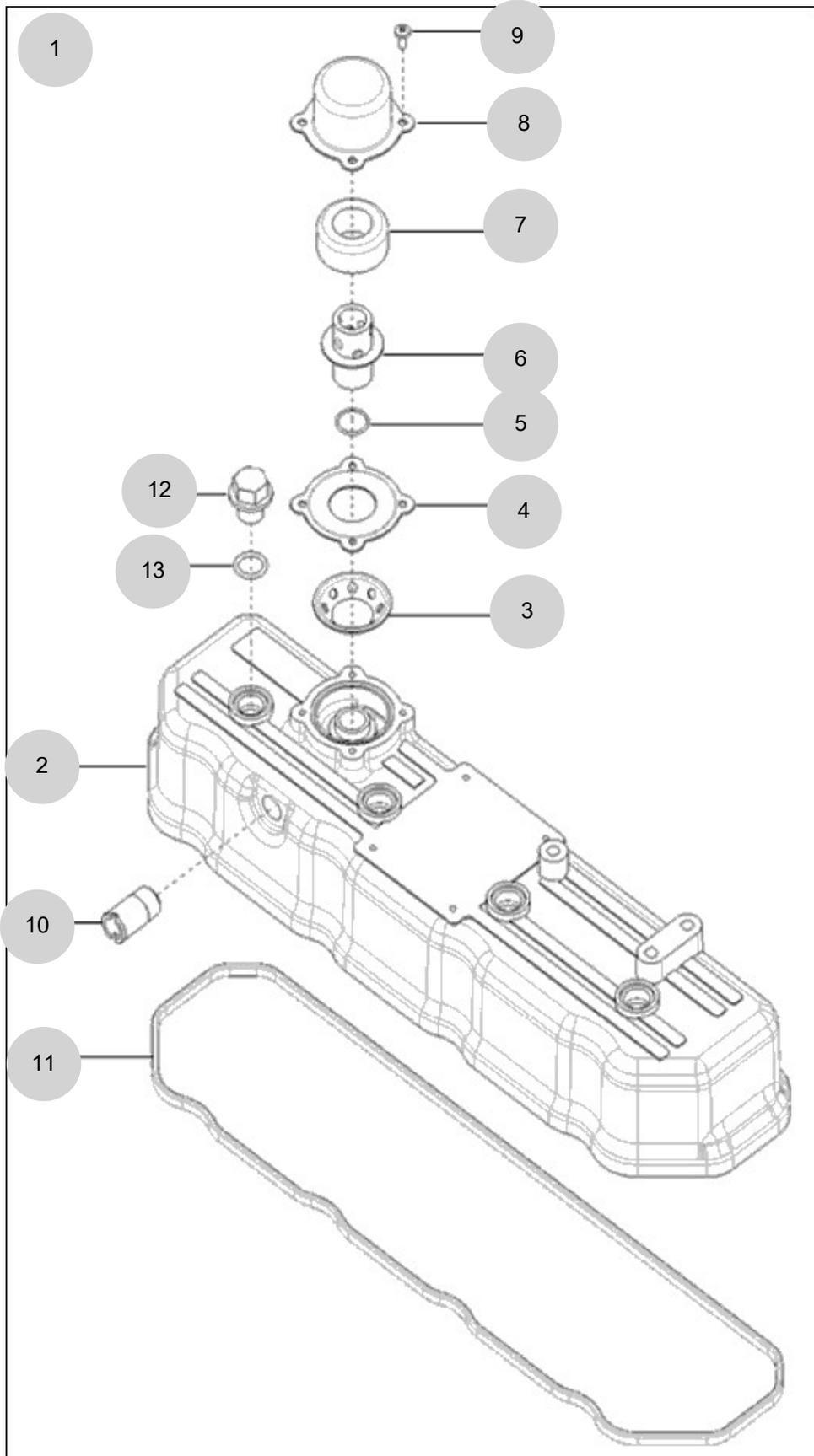

NOTE

FIG 108

T494NH

GEAR CASE

년/월
Year/Month

2022-12

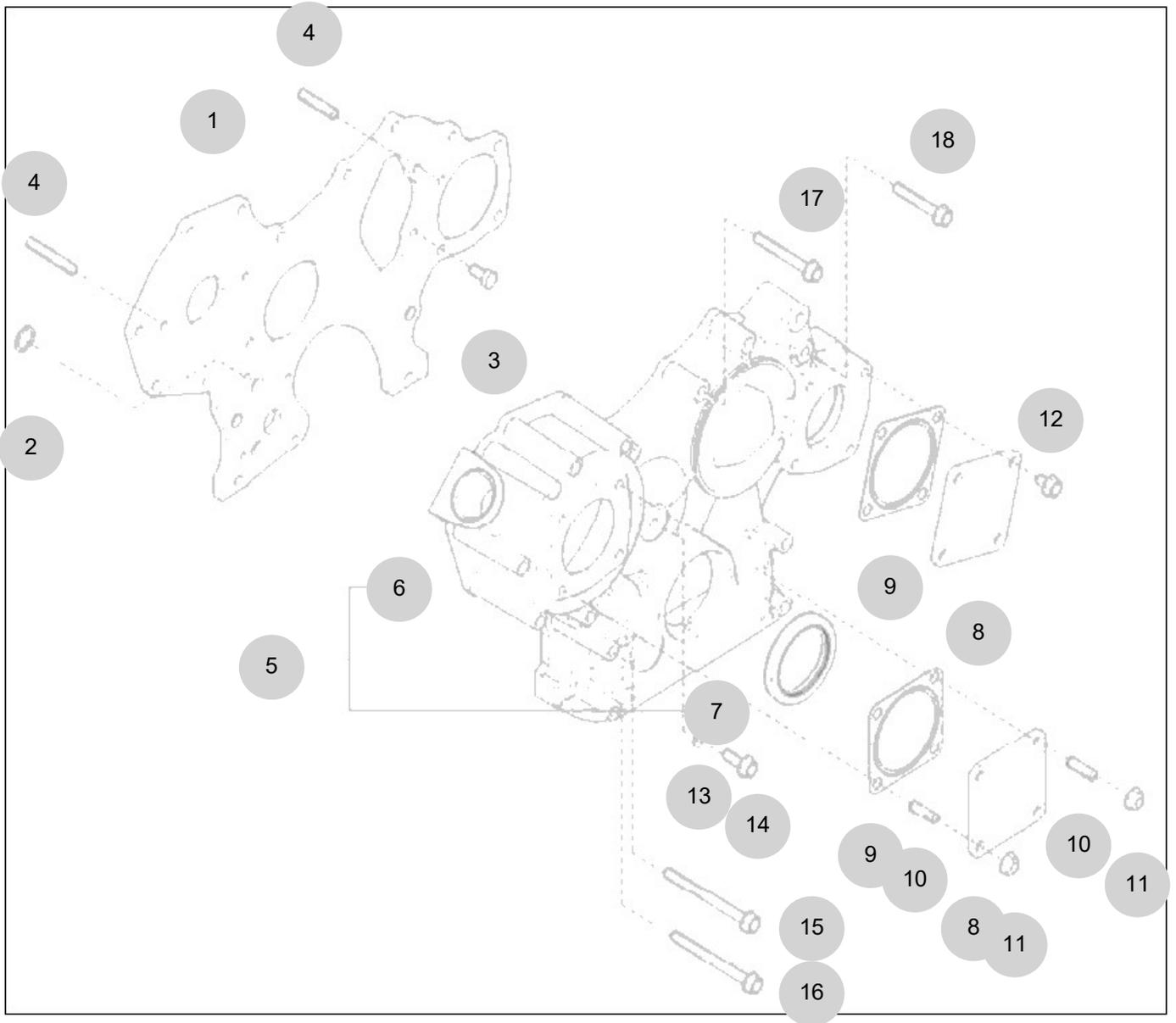

NOTE

FIG 109

IDLE GEAR

년/월
Year/Month

T494NH

2022-12

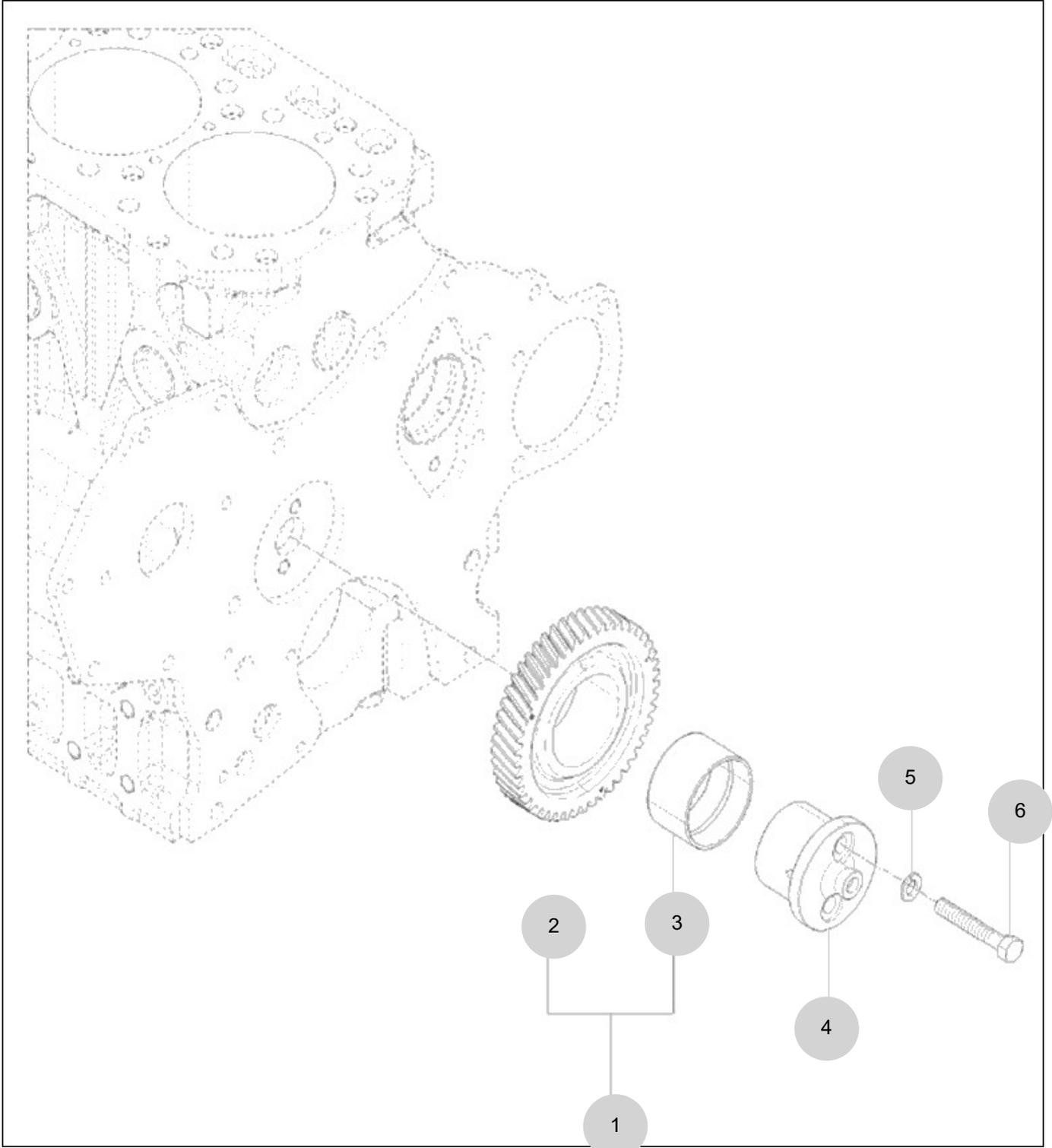

NOTE

FIG 110

T494NH

CAM SHAFT

년/월
Year/Month

2022-12

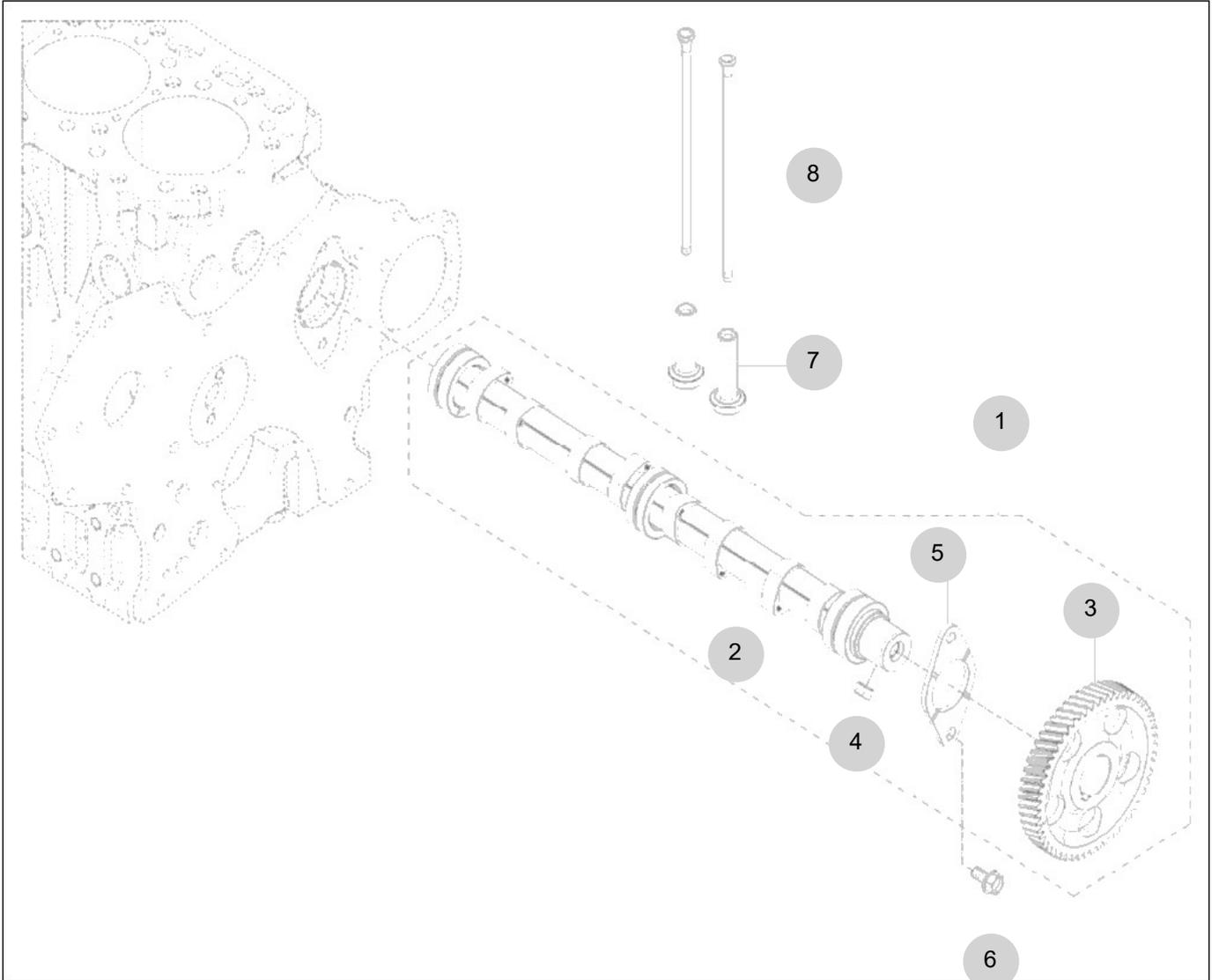

NOTE

FIG 111

OIL PUMP

년/월
Year/Month

2022-12

T494NH

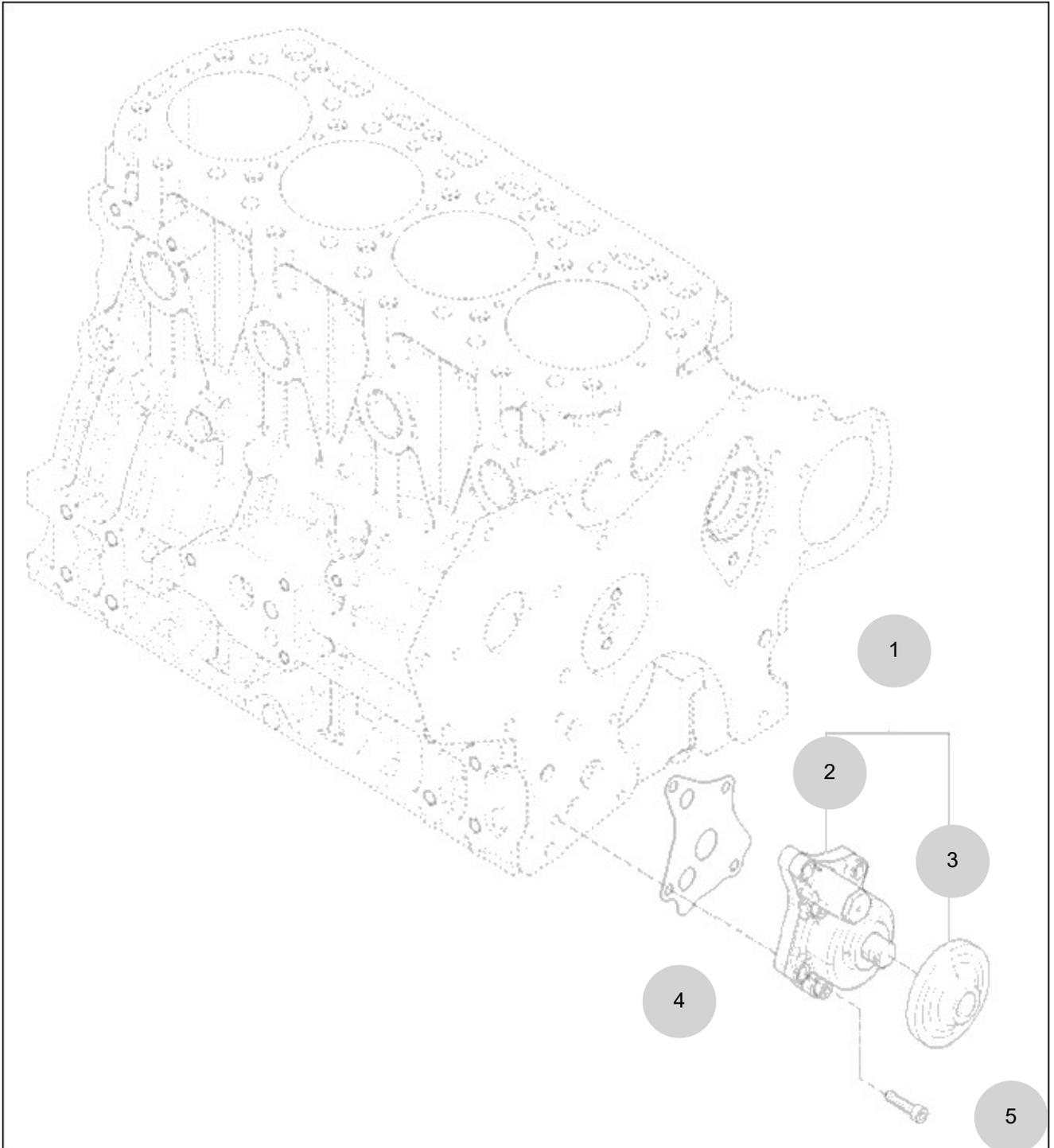

NOTE

FIG 112

T494NH

HYD. PUMP DRIVE

년/월
Year/Month

2022-12

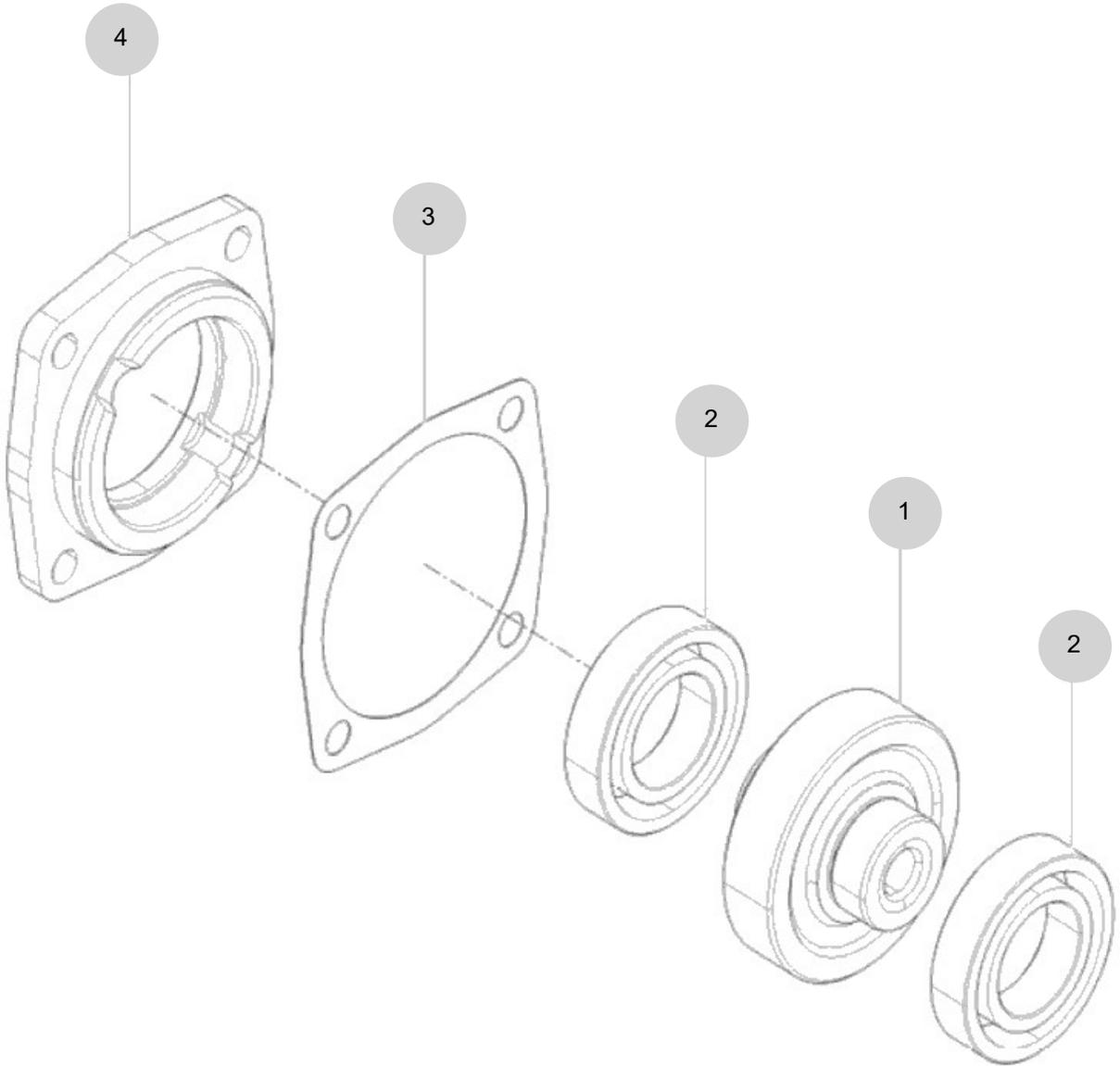

NOTE

FIG 113

2ND BALANCE

년/월
Year/Month

2022-12

T494NH

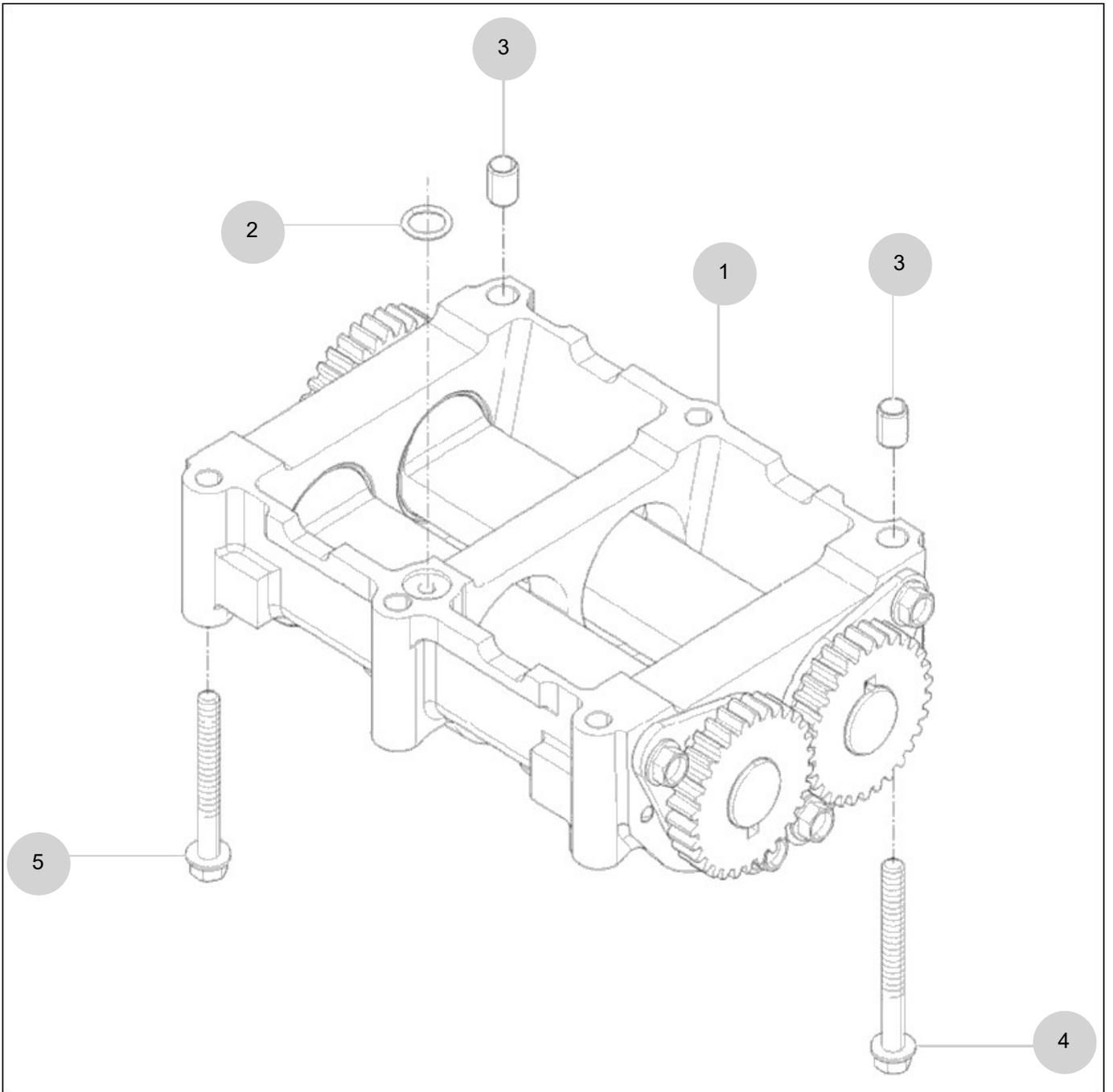

NOTE

FIG 114

T494NH

OIL PAN

년/월
Year/Month

2022-12

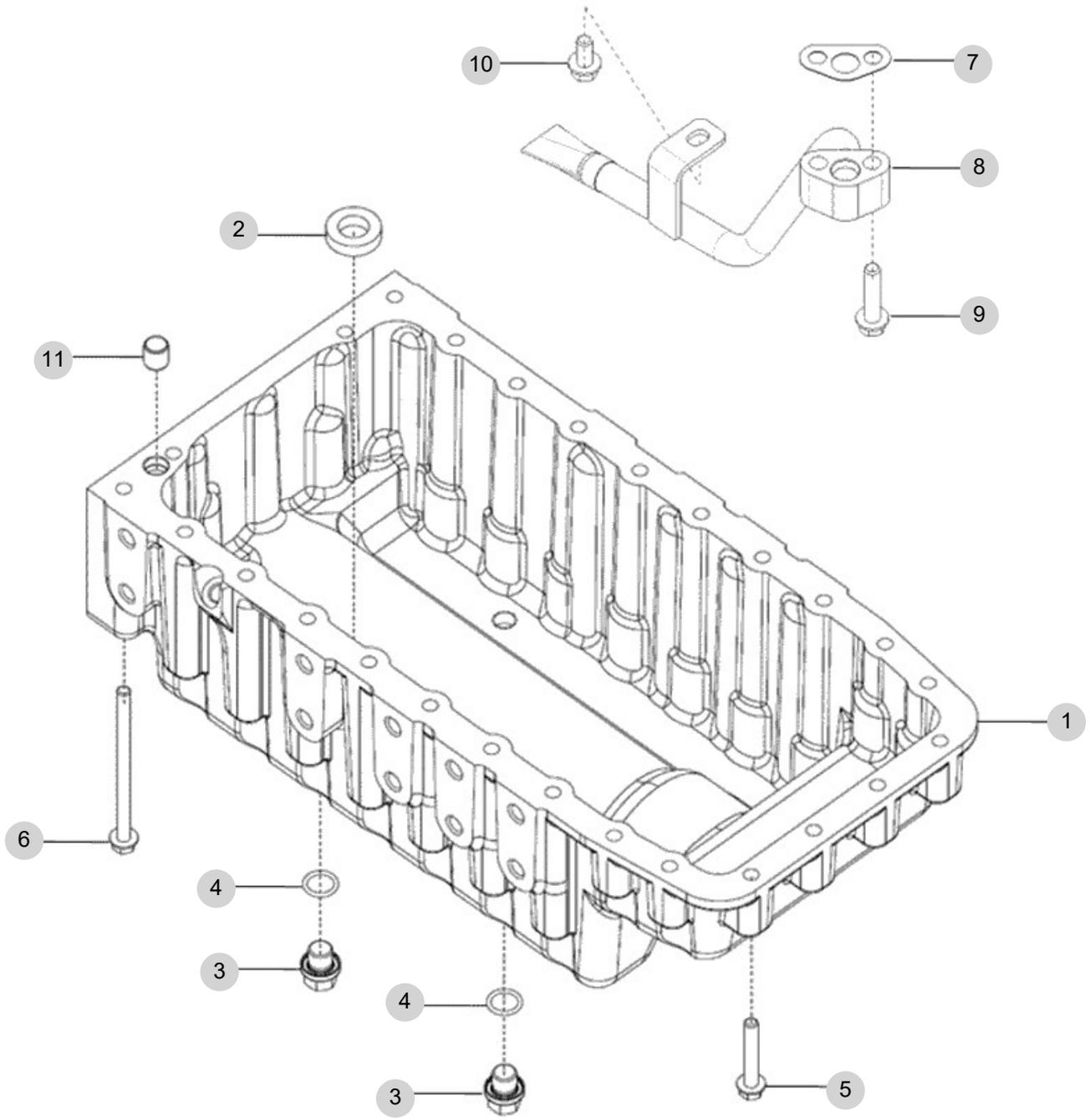

NOTE

FIG 115B

T494NH

INTAKE MANIFOLD(T494)

년/월
Year/Month

2022-12

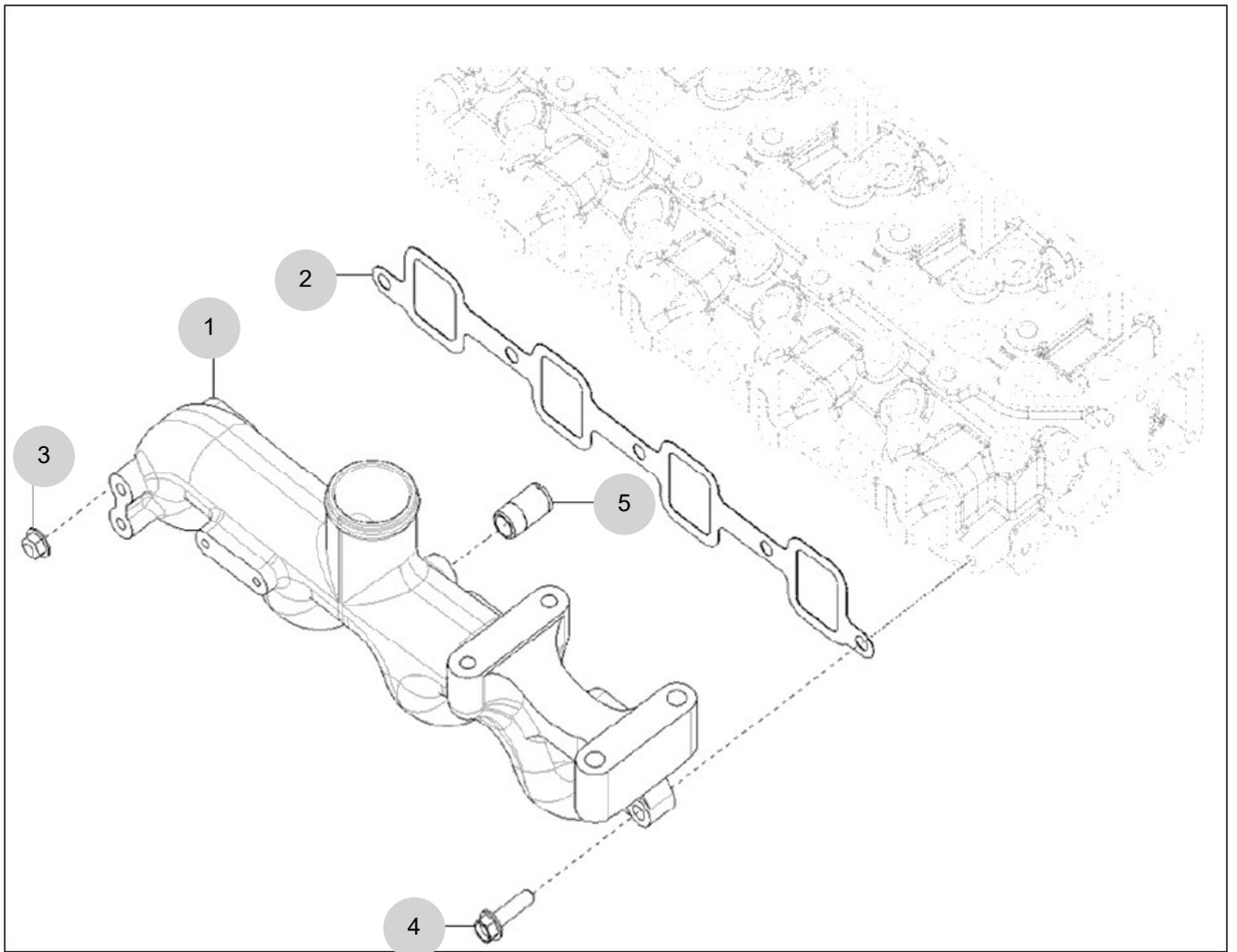

NOTE

FIG 116B

T494NH

EXHAUST MANIFOLD(T494)

년/월
Year/Month

2022-12

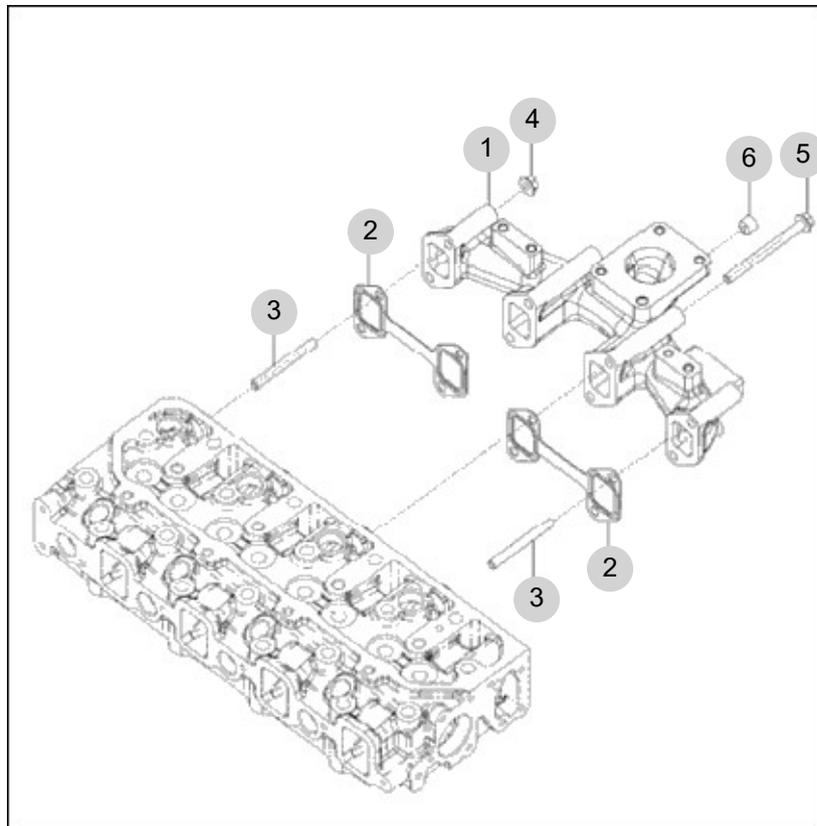

NOTE

FIG 117B

TURBOCHARGER ASS'Y(T494)

년/월
Year/Month

T494NH

2022-12

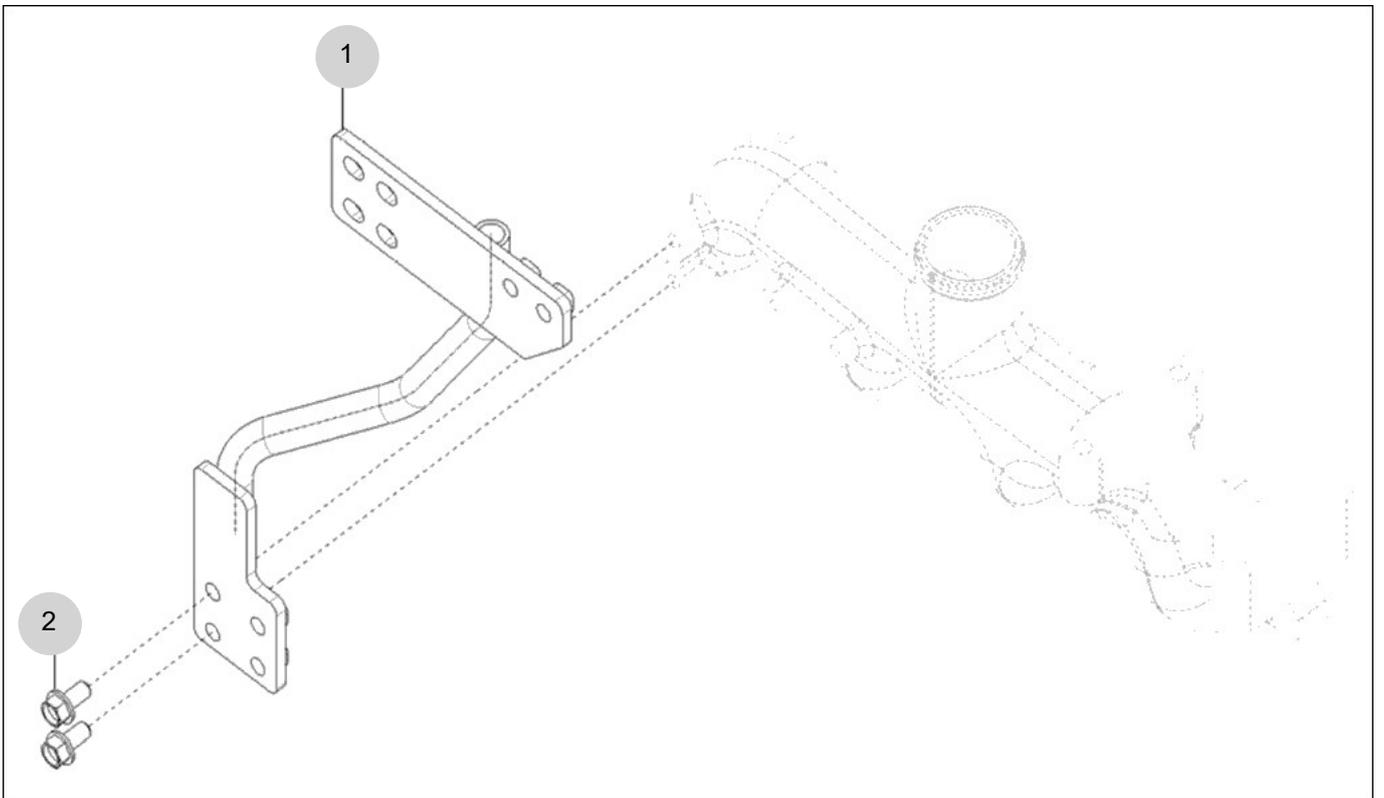

NOTE

FIG 118B

TURBOCHARGER PLUMBING OPTION(T494)

년/월
Year/Month

2022-12

T494NH

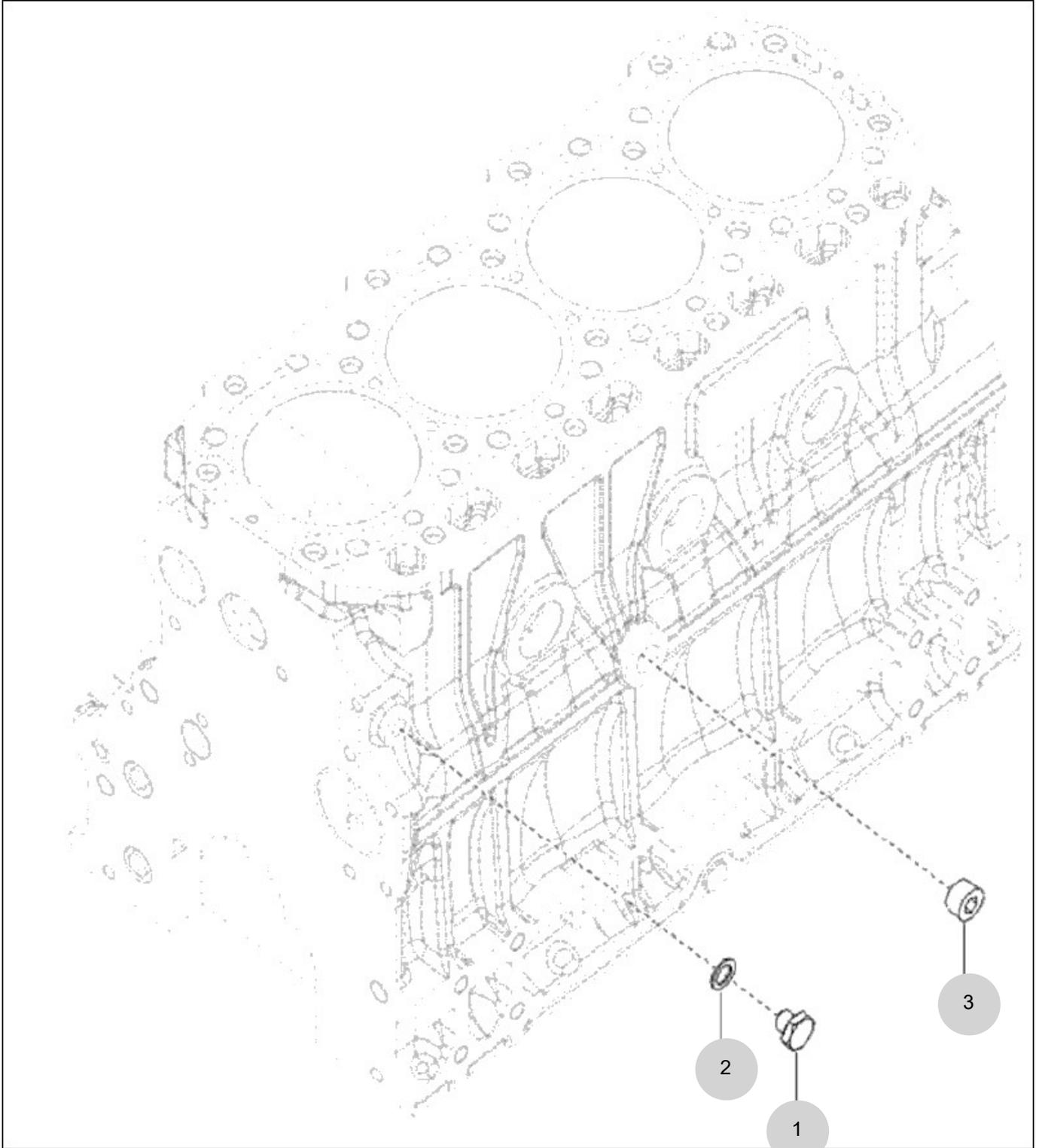

NOTE

FIG 119B

BREATHER(T494)

년/월
Year/Month

T494NH

2022-12

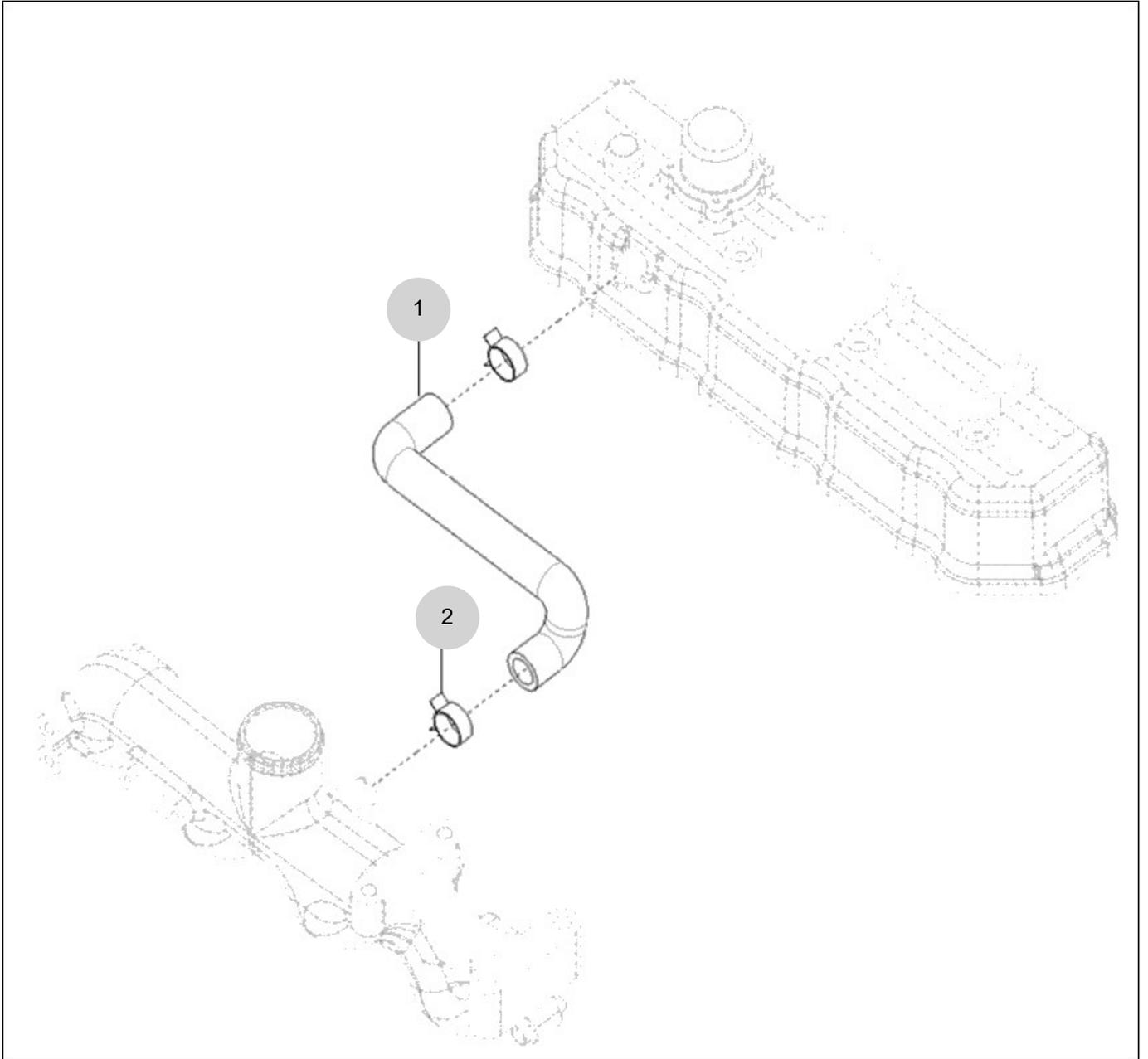

NOTE

FIG 120

T494NH

FUEL INJECTION PUMP

년/월
Year/Month

2022-12

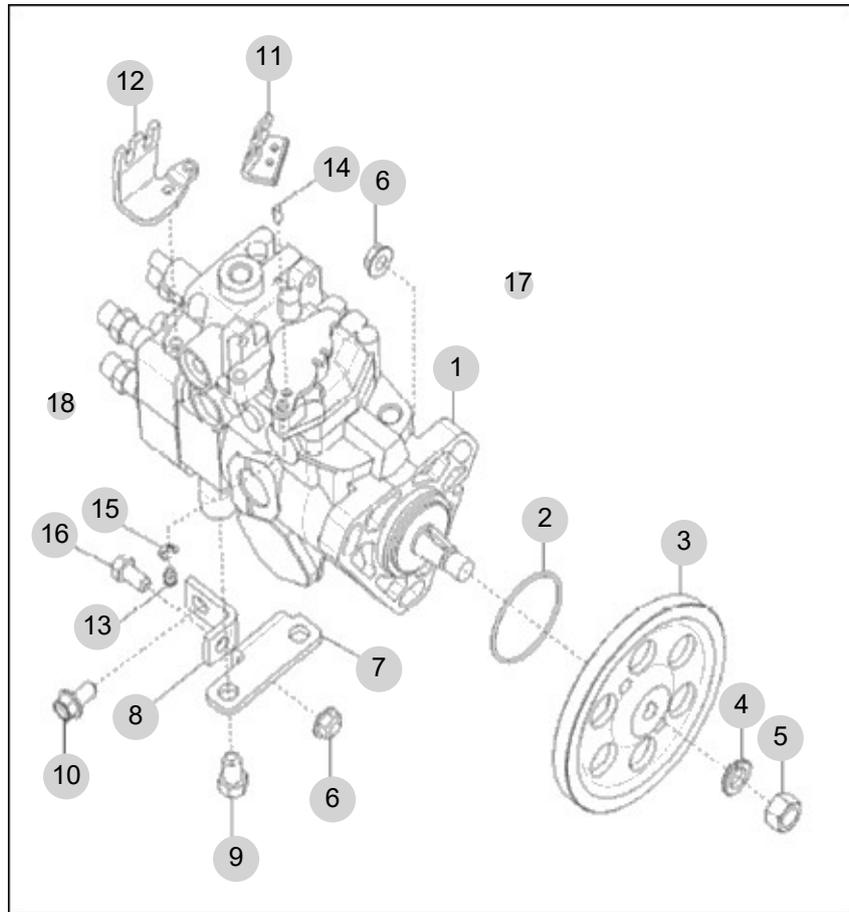

NOTE

FIG 121

T494NH

FUEL INJECTION VALVE

년/월
Year/Month

2022-12

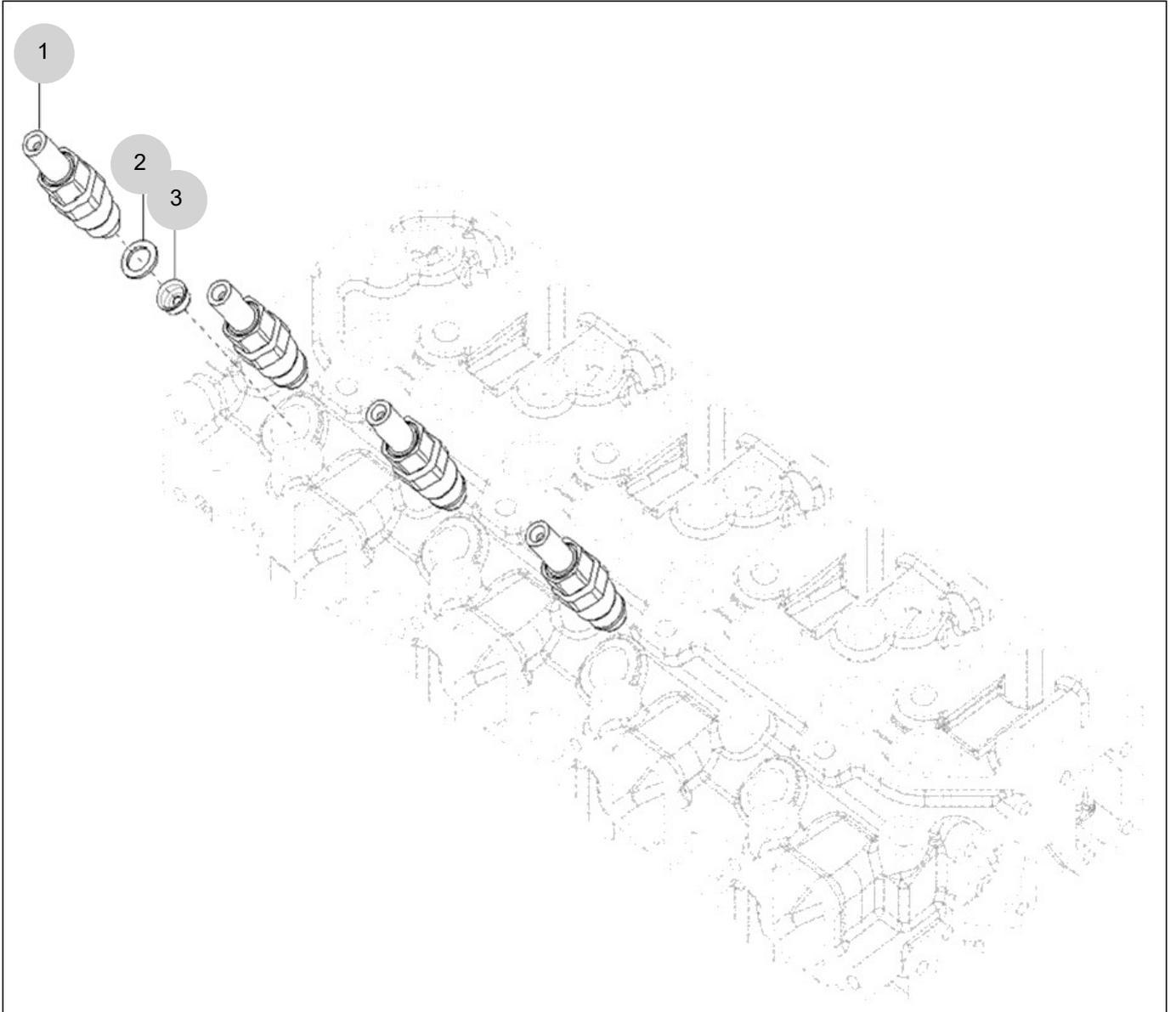

NOTE

FIG 122

FUEL PIPE ASS'Y

년/월
Year/Month

2022-12

T494NH

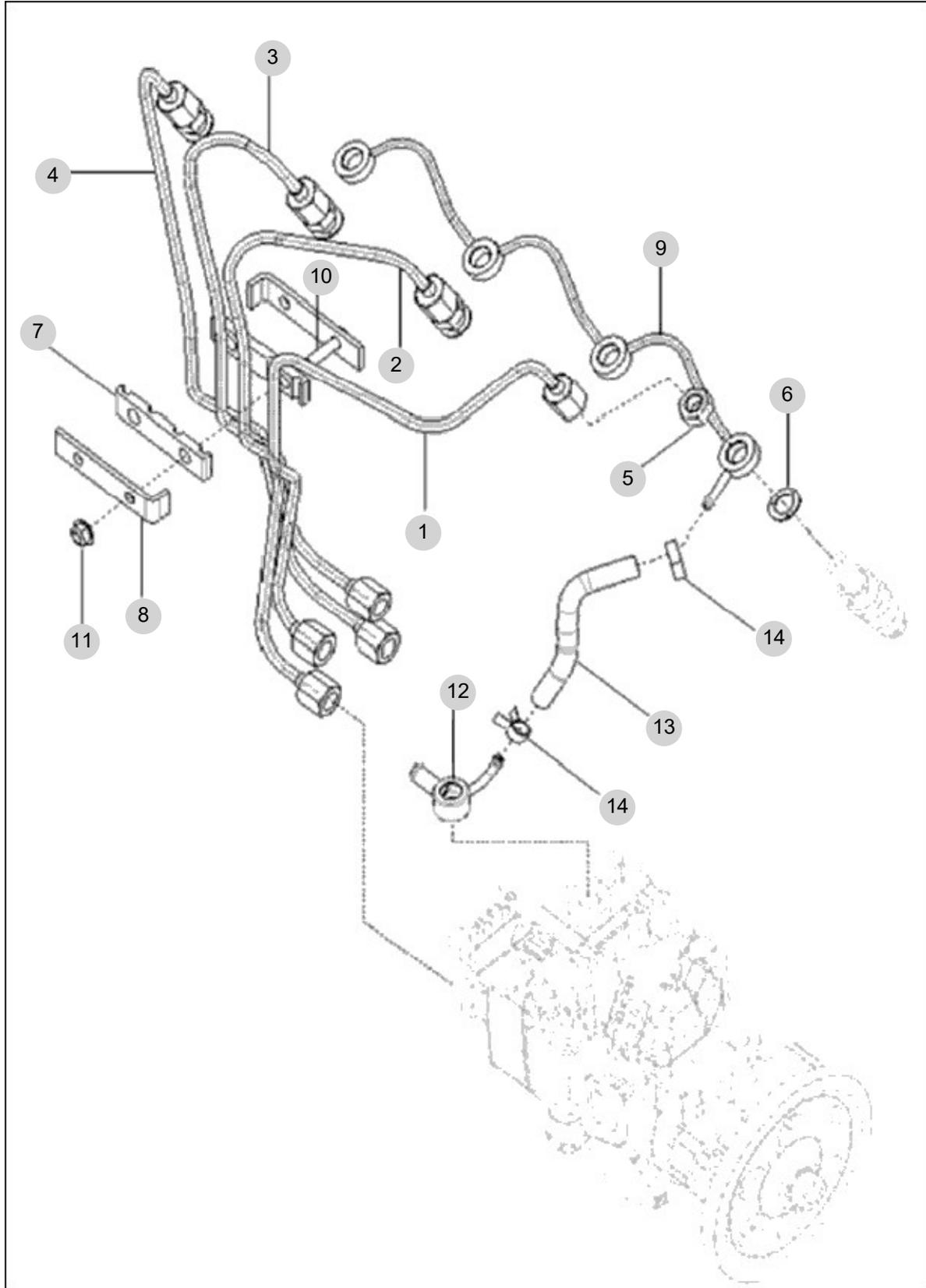

NOTE

FIG 123

T494NH

OIL FILTER

년/월
Year/Month

2022-12

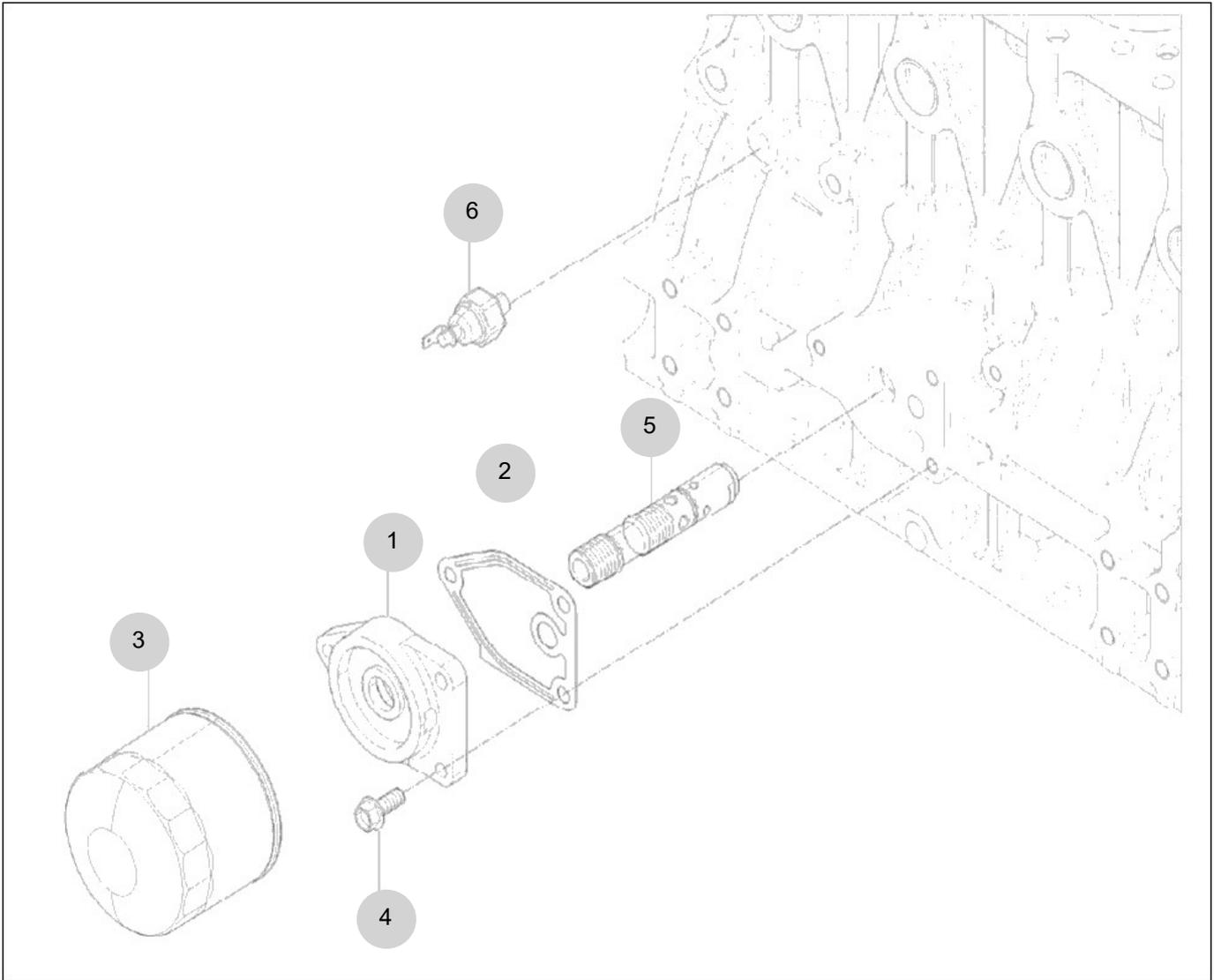

NOTE

FIG 124

OIL COOLER

년/월
Year/Month

T494NH

2022-12

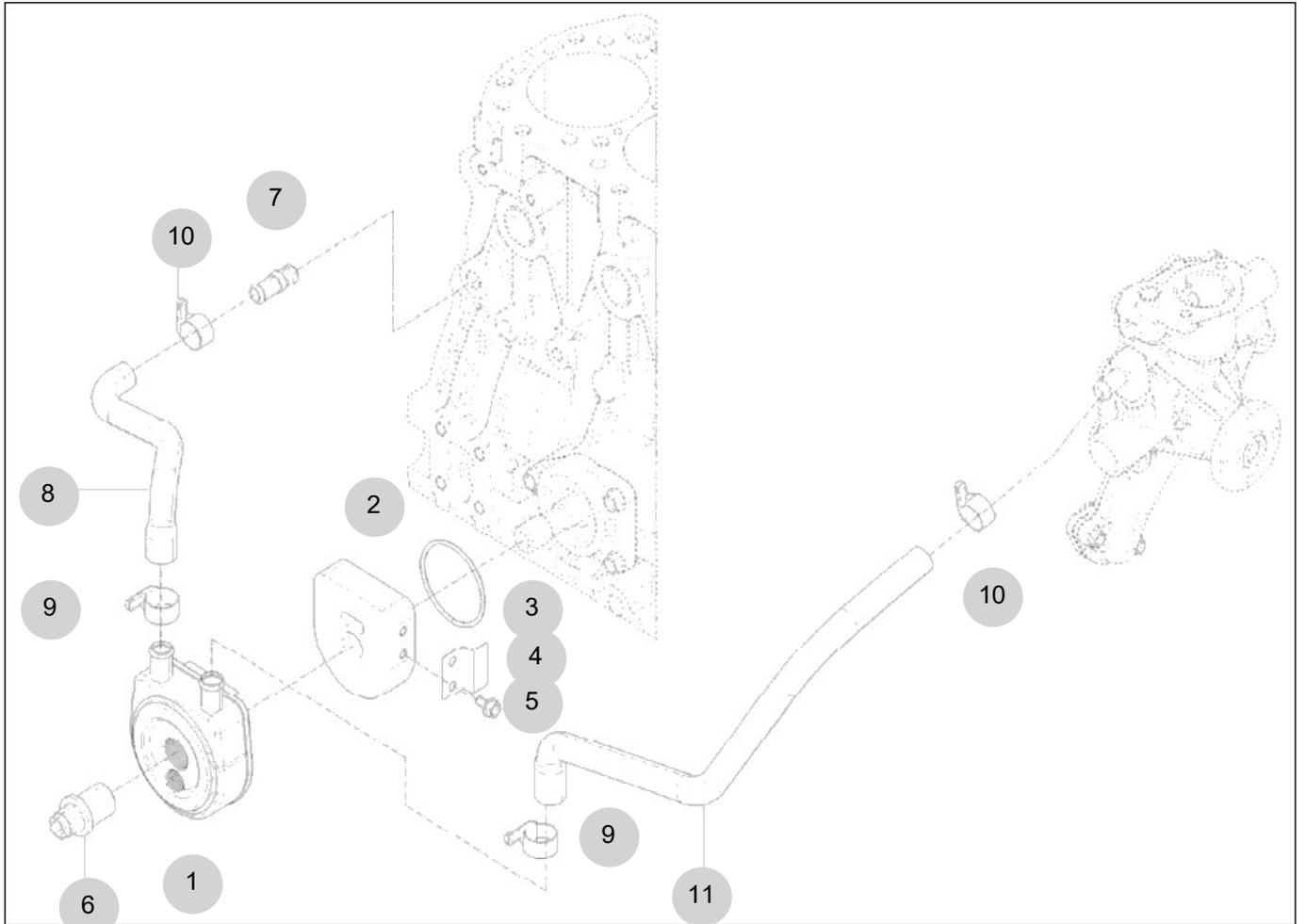

NOTE

FIG 125

OIL GAUGUE

년/월
Year/Month

T494NH

2022-12

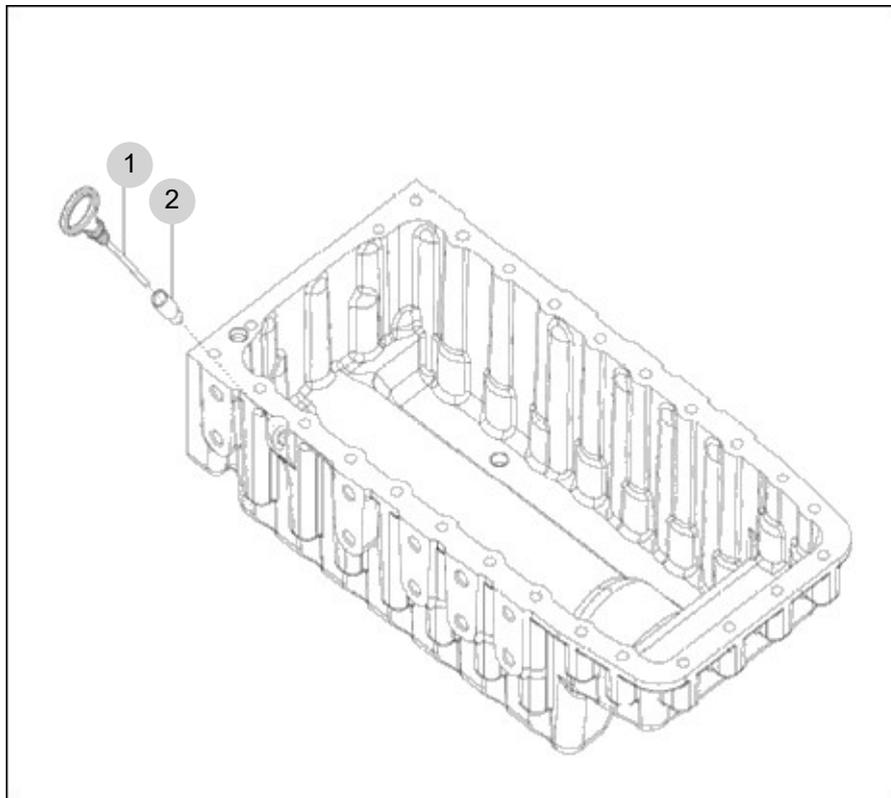

NOTE

FIG 126

T494NH

OIL FILLER CAP

년/월
Year/Month

2022-12

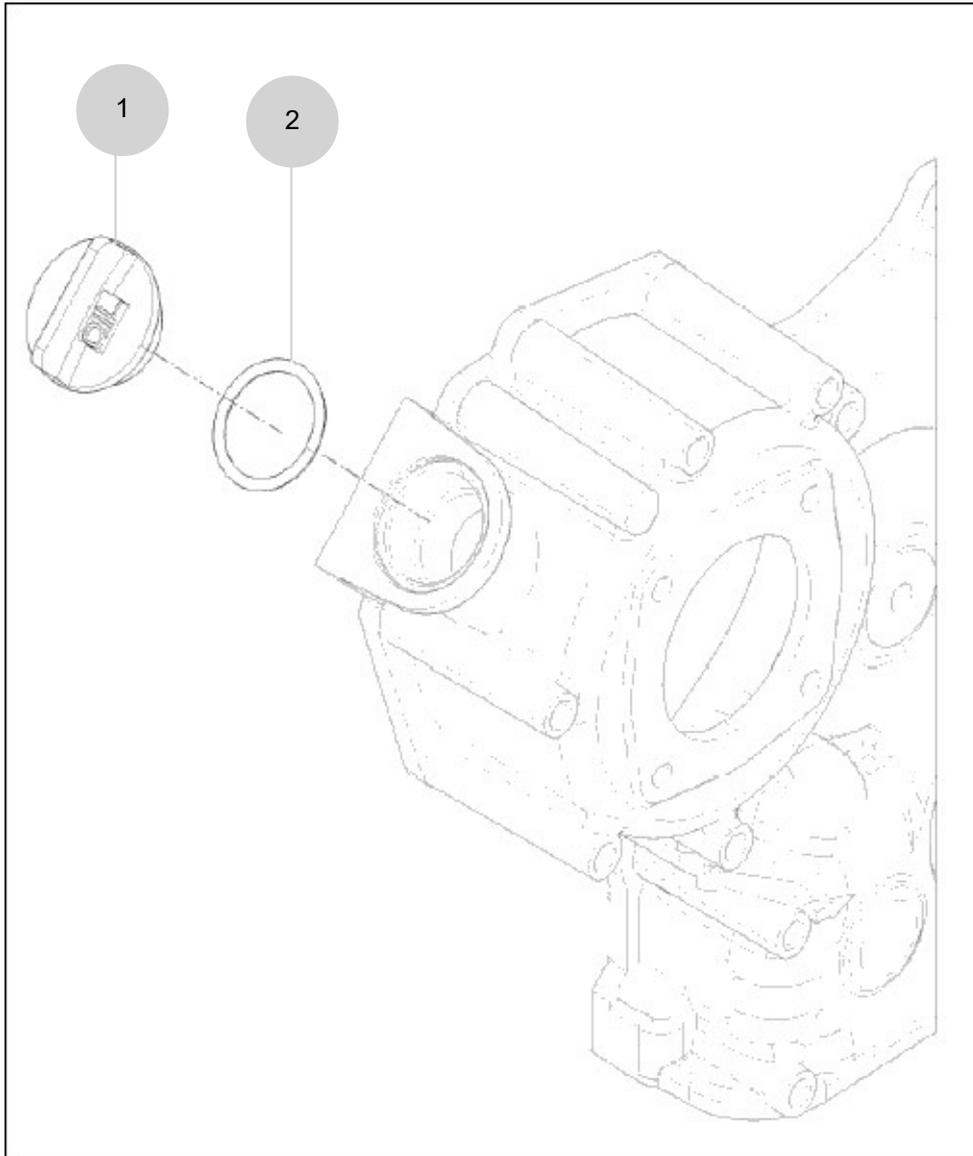

NOTE

FIG 127

COOLING WATER PUMP

년/월
Year/Month

2022-12

T494NH

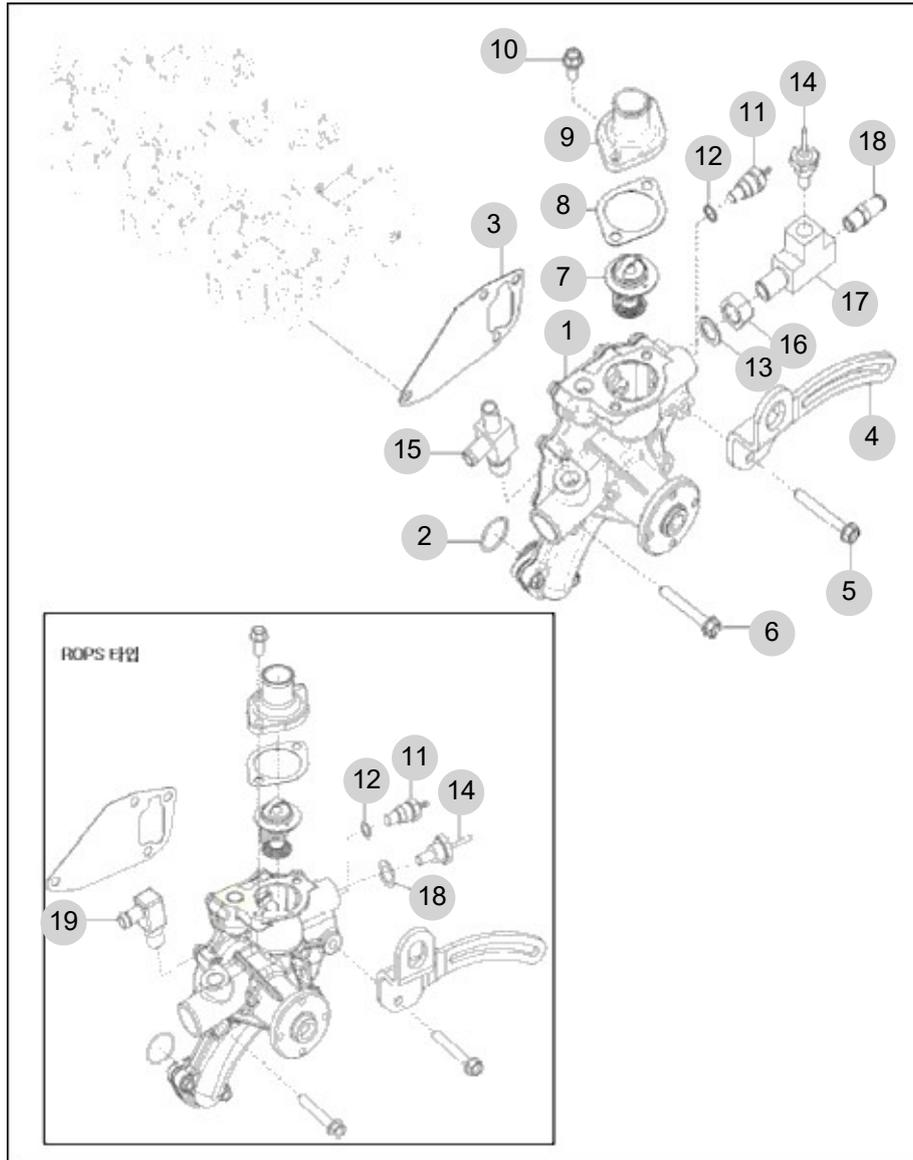

NOTE

FIG 128

T494NH

CRANK SHAFT PULLEY

년/월
Year/Month

2022-12

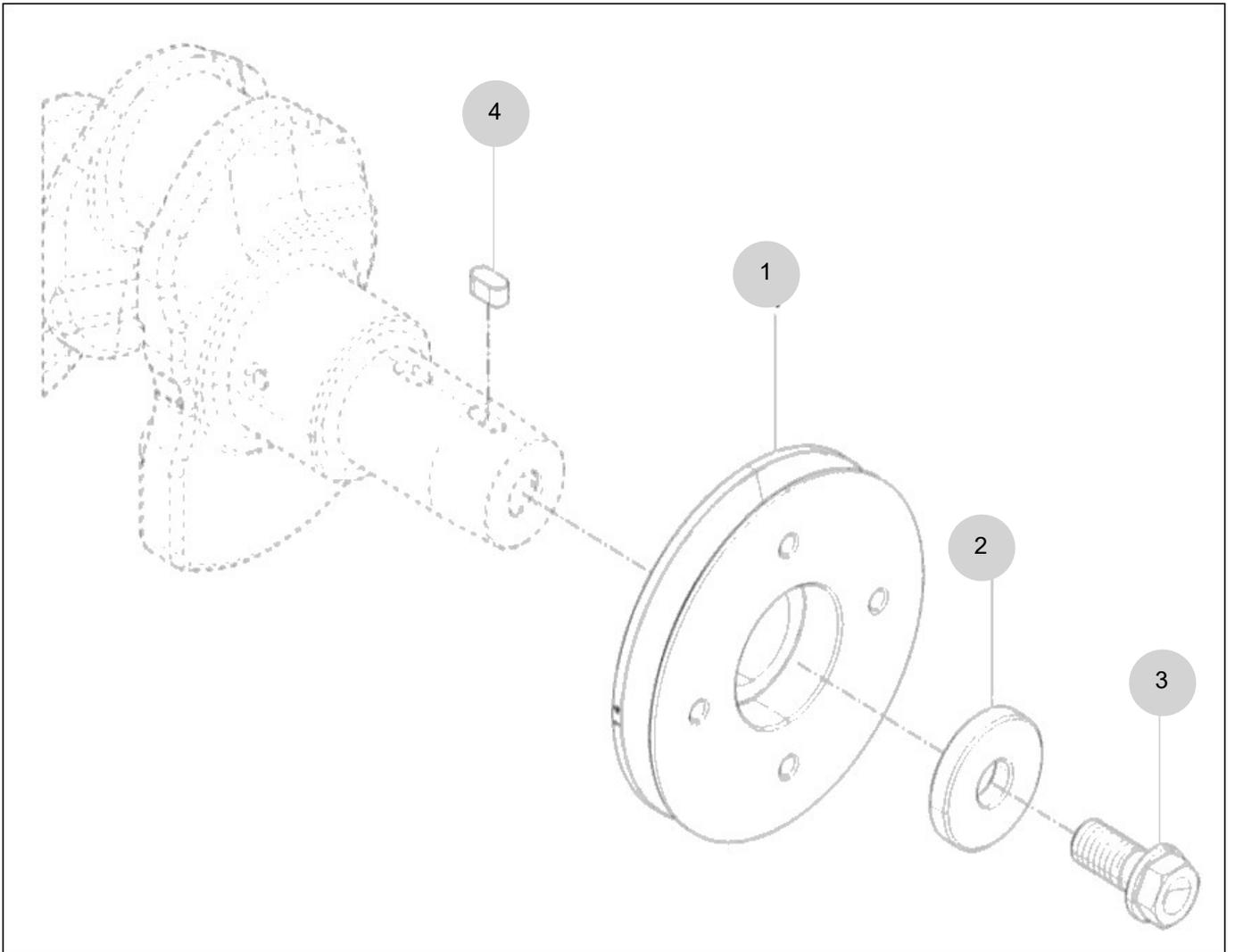

NOTE

FIG 129

V-PULLEY

년/월
Year/Month

T494NH

2022-12

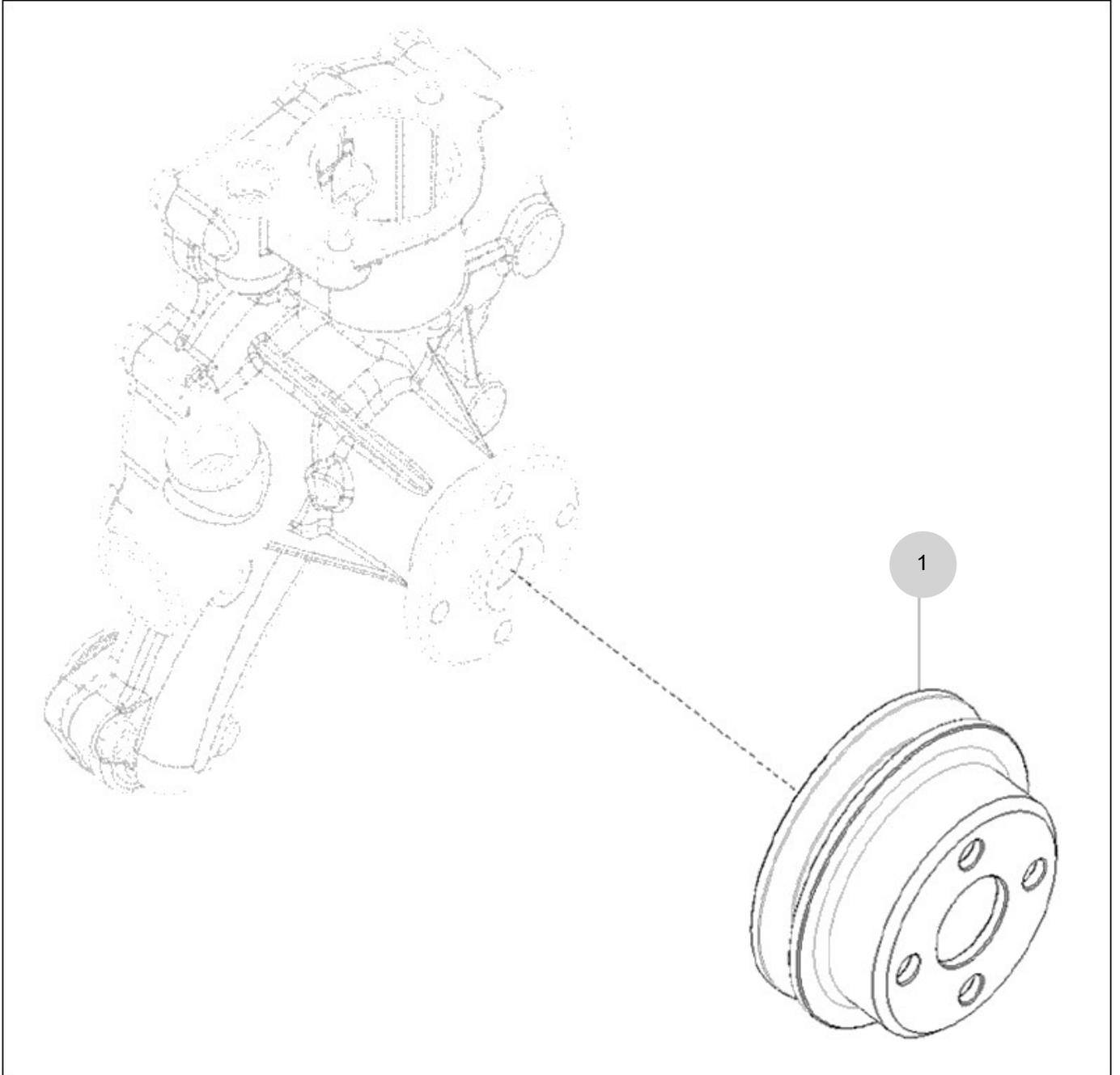

NOTE

FIG 130

COOLING FAN

년/월
Year/Month

T494NH

2022-12

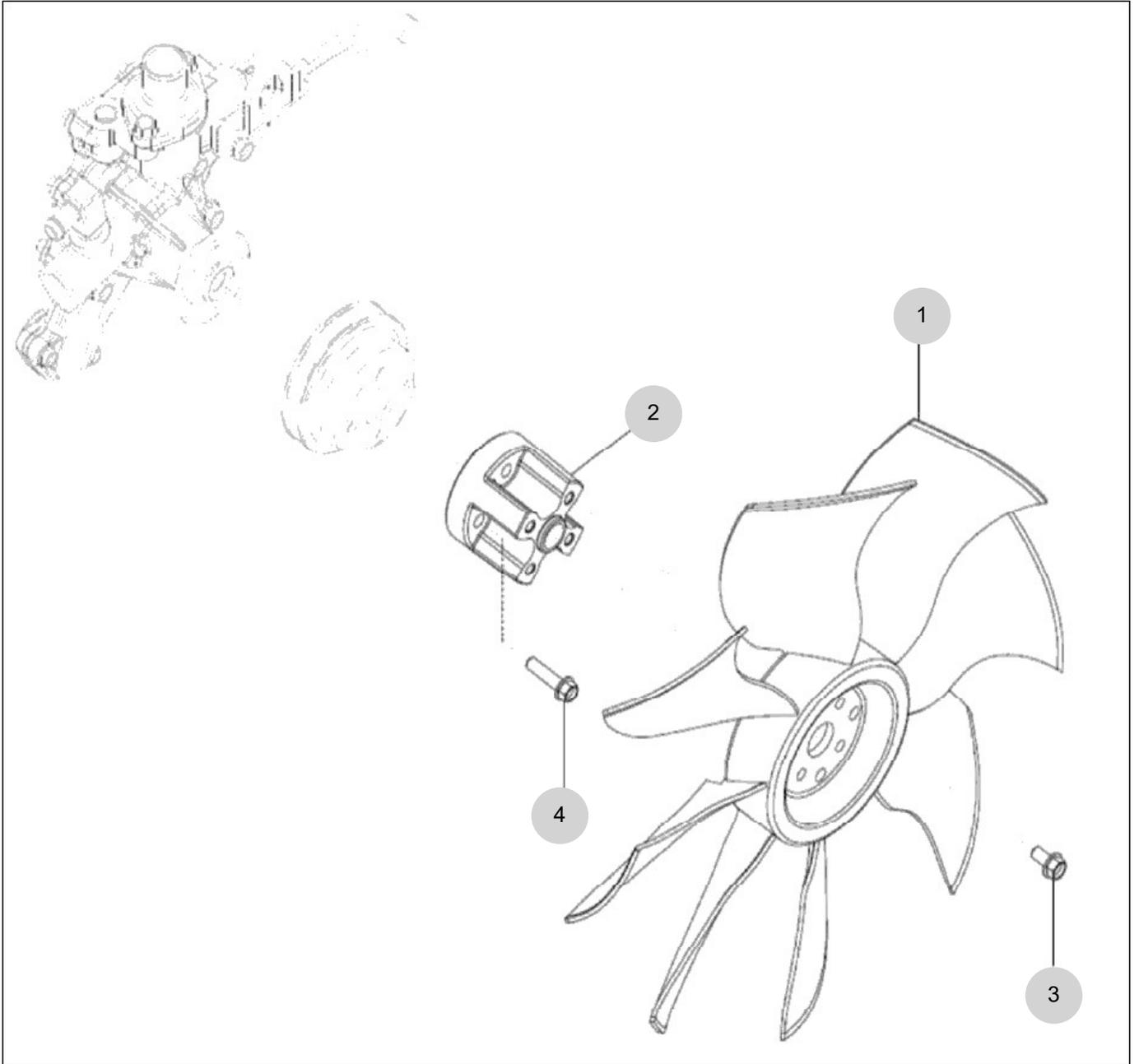

NOTE

FIG 131

T494NH

FLYWHEEL HOUSING

년/월
Year/Month

2022-12

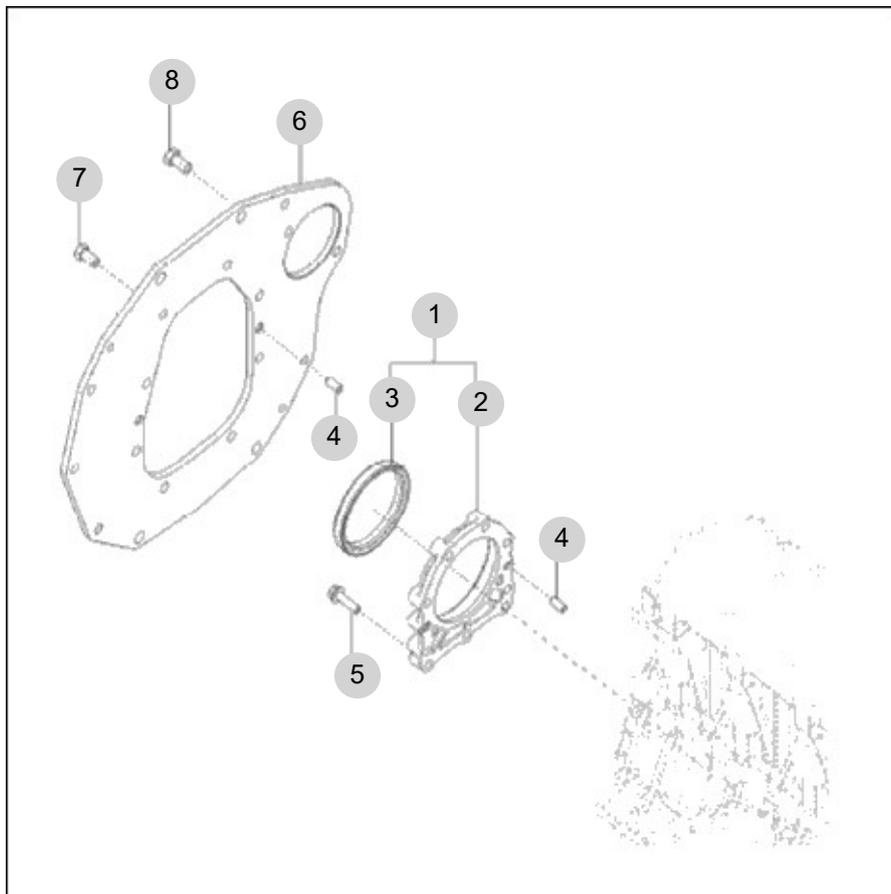

NOTE

FIG 132

T494NH

FLYWHEEL

년/월
Year/Month

2022-12

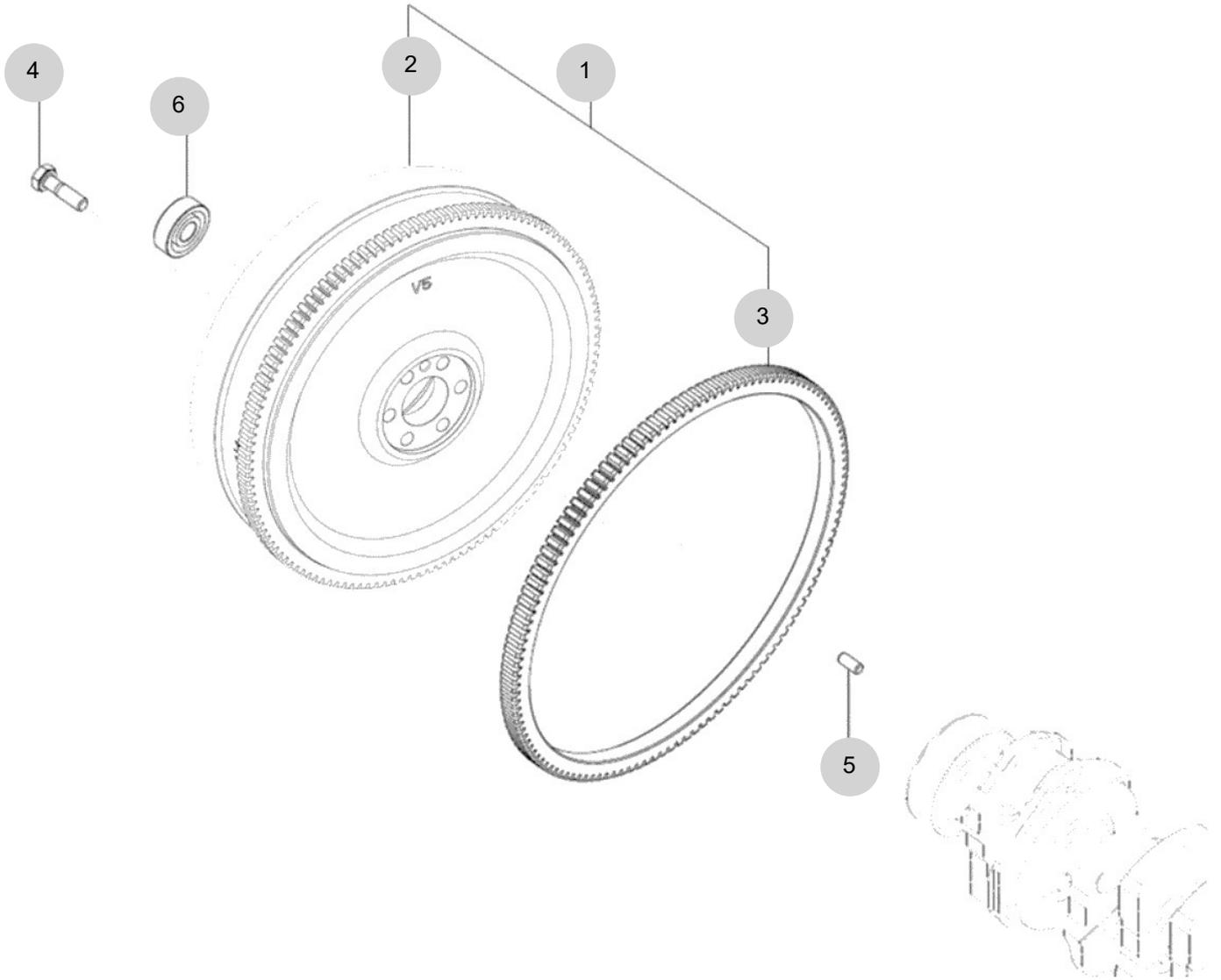

NOTE

FIG 133

T494NH

GLOW PLUG ASS'Y OPTION

년/월
Year/Month

2022-12

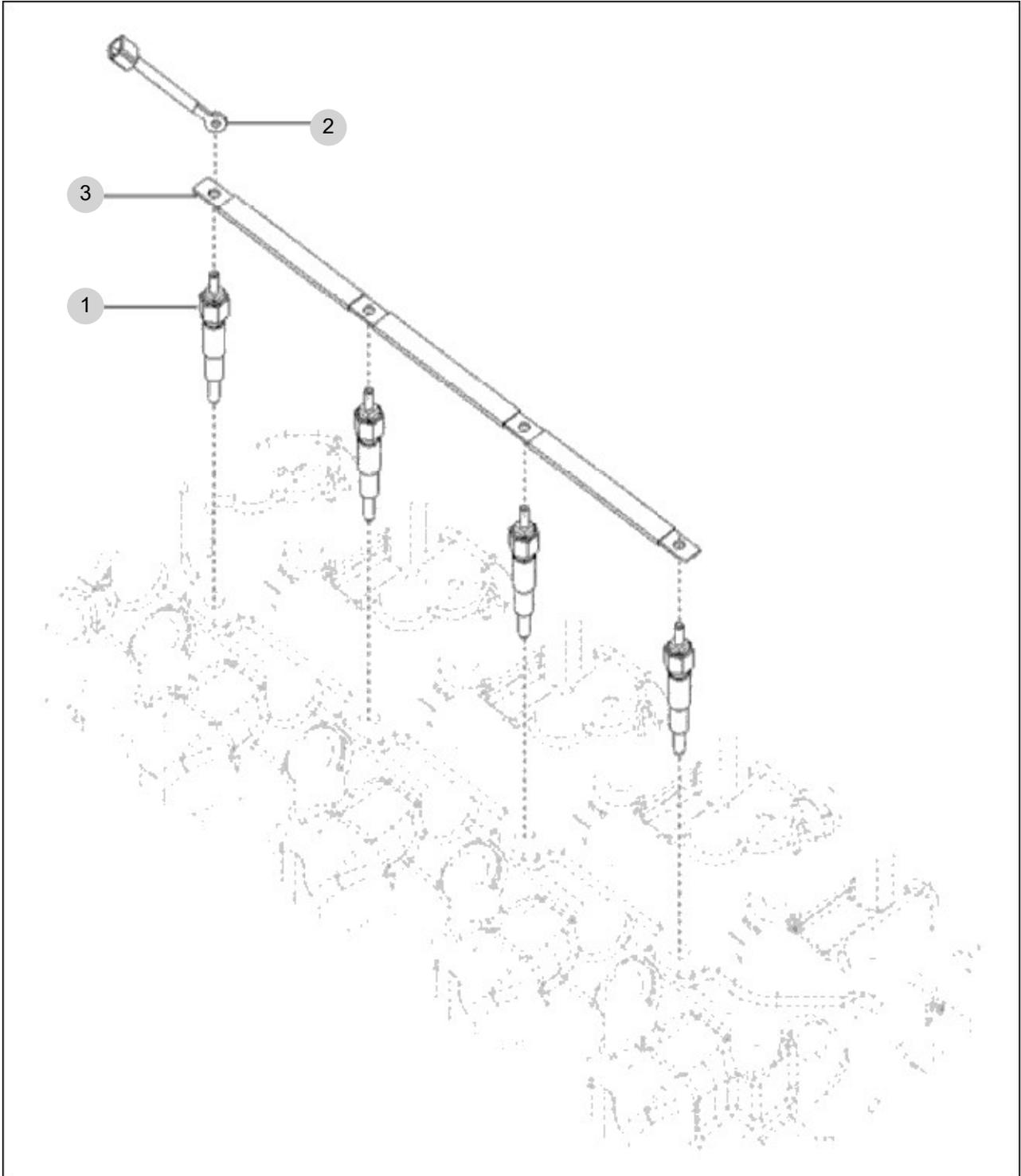

NOTE

FIG 134

STARTING MOTOR

년/월
Year/Month

2022-12

T494NH

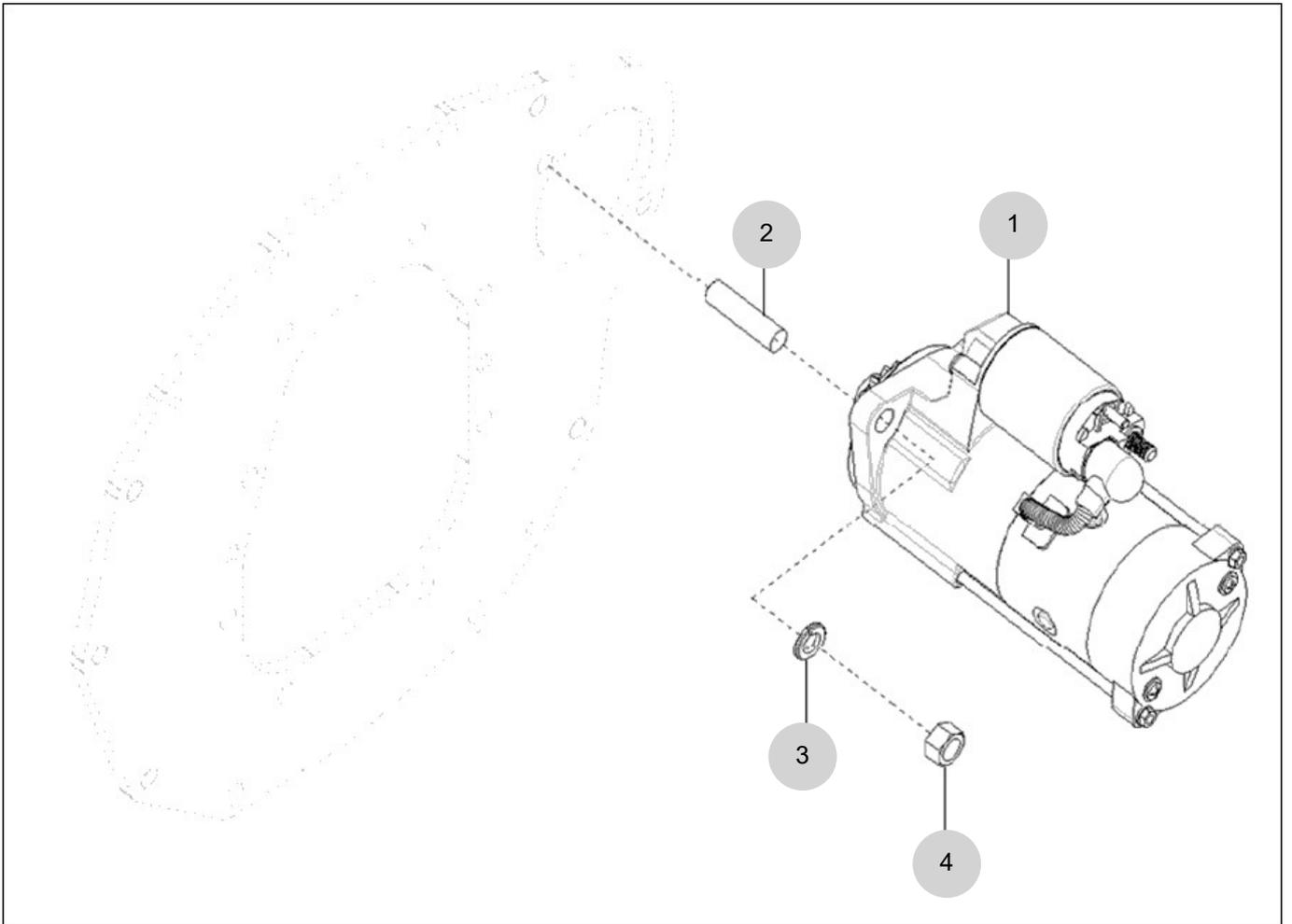

NOTE

FIG 135

T494NH

FUEL FILTER BRACKET ASS'Y

년/월
Year/Month

2022-12

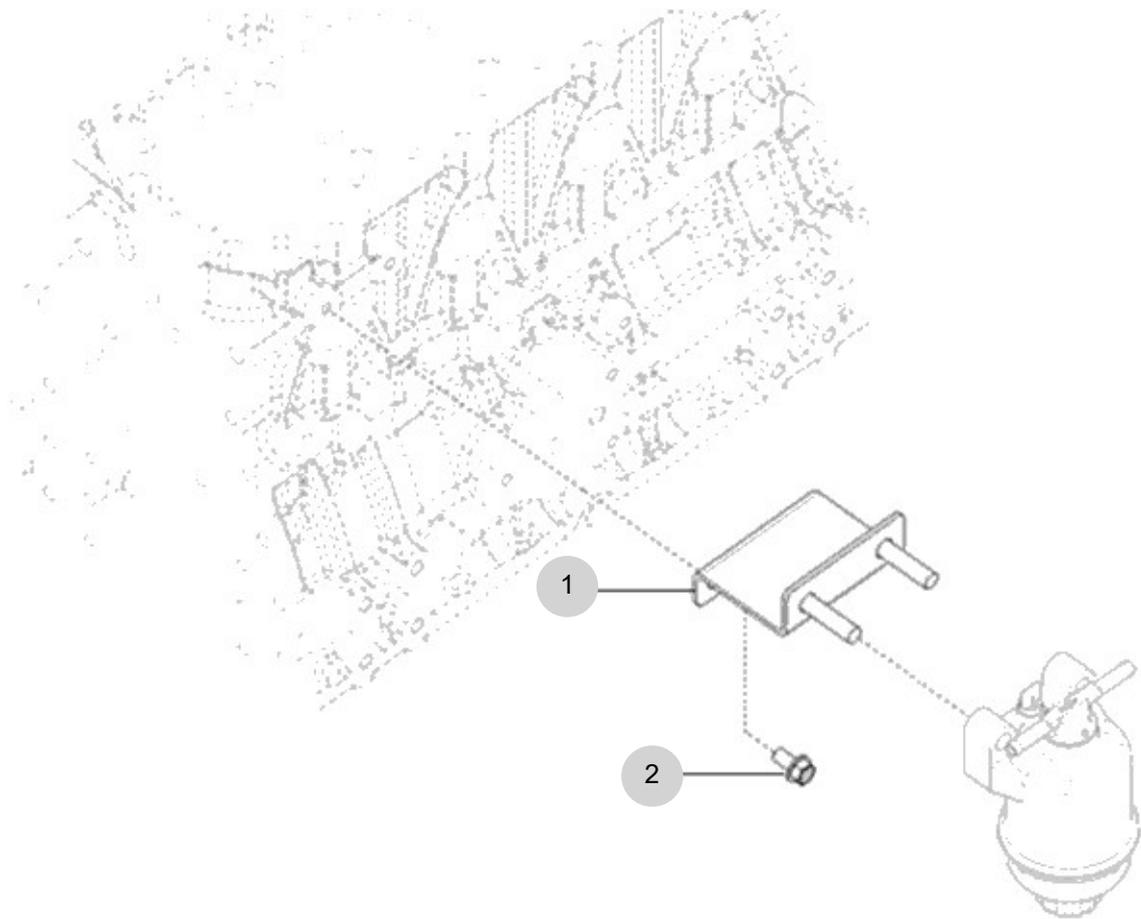

NOTE

FIG 136

ALTERNATOR

년/월
Year/Month

2022-12

T494NH

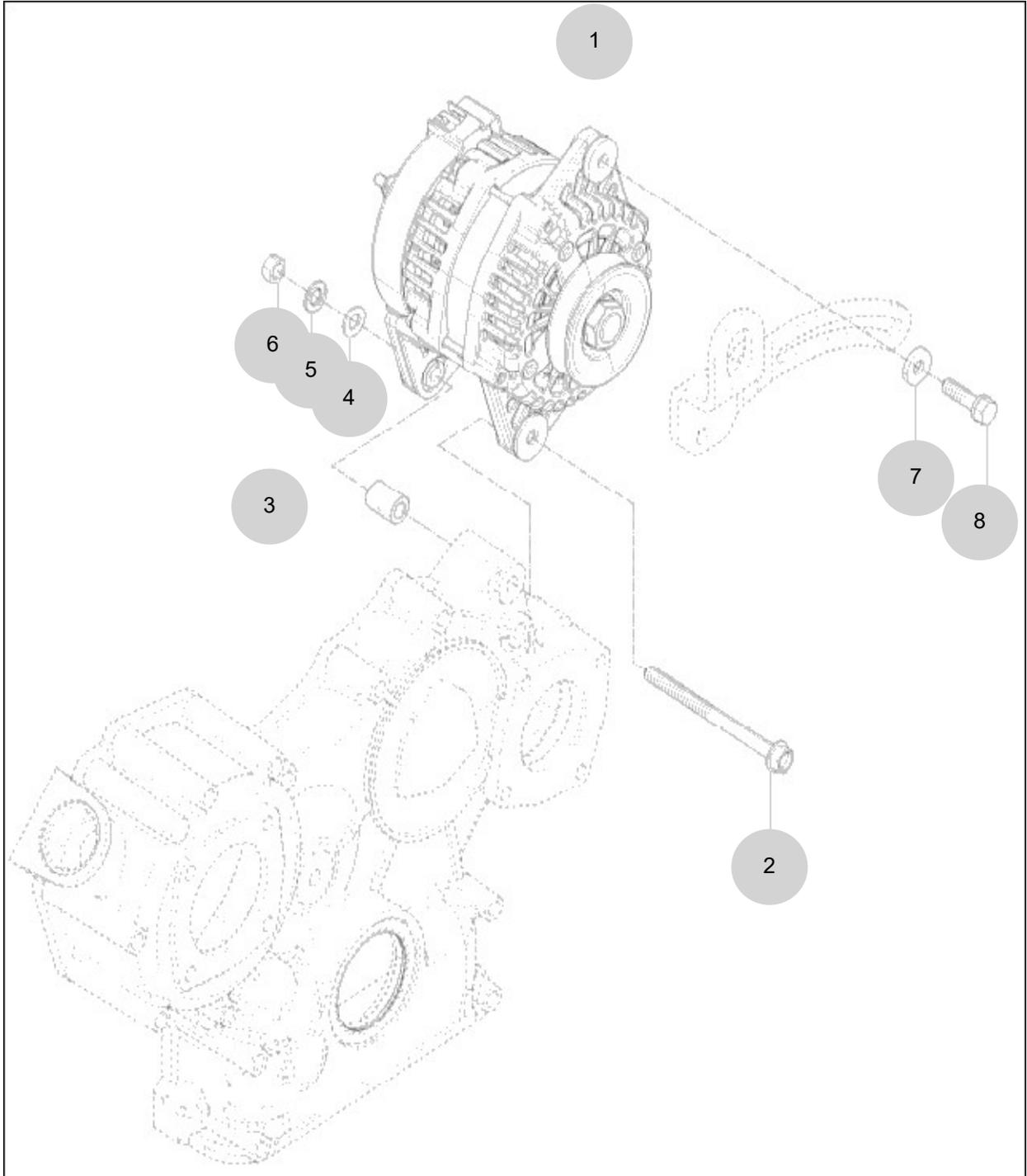

NOTE

FIG 137

T494NH

V-BELT

년/월
Year/Month

2022-12

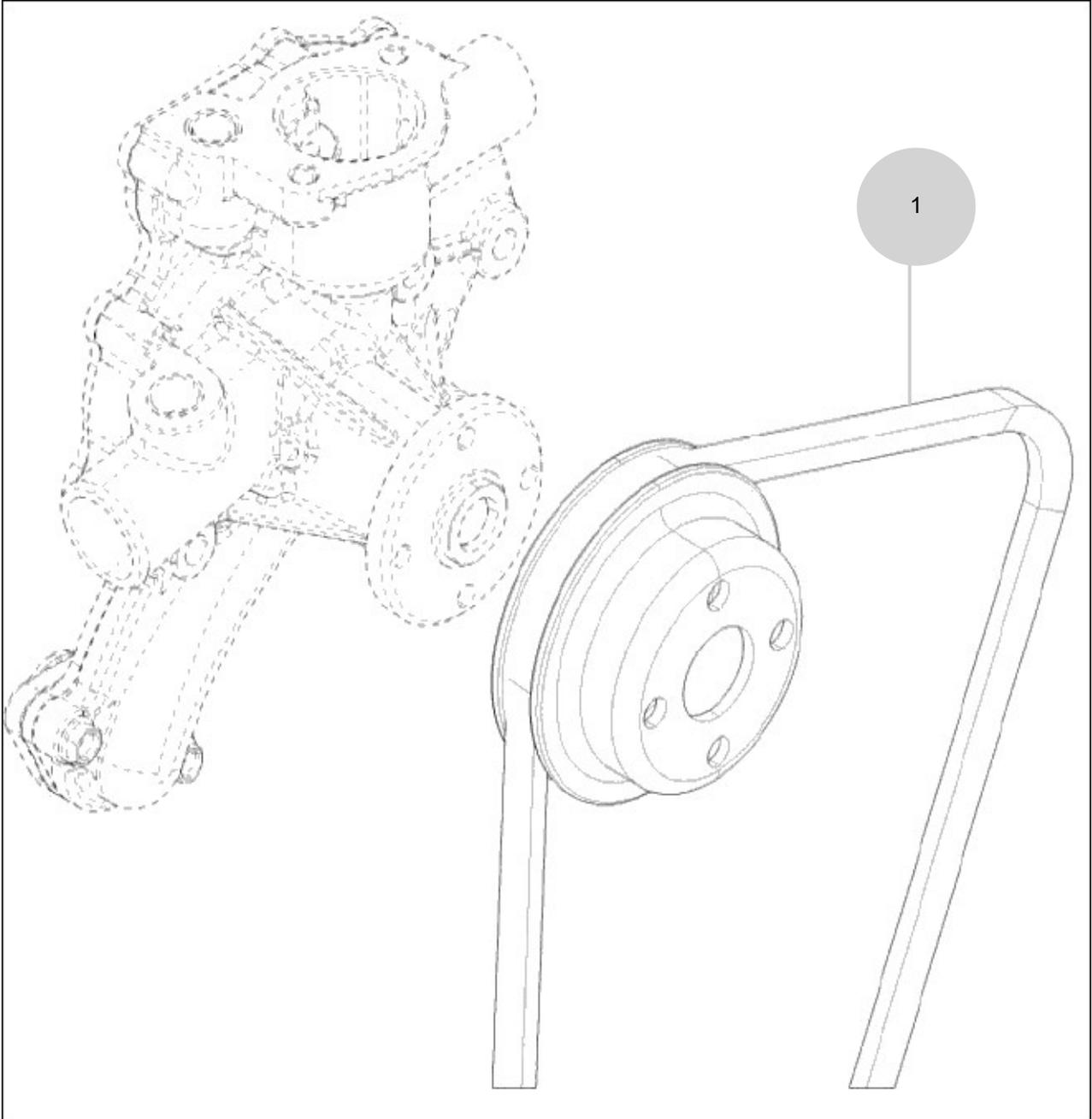

NOTE

FIG 138

T494NH

FUEL FILTER

년/월
Year/Month

2022-12

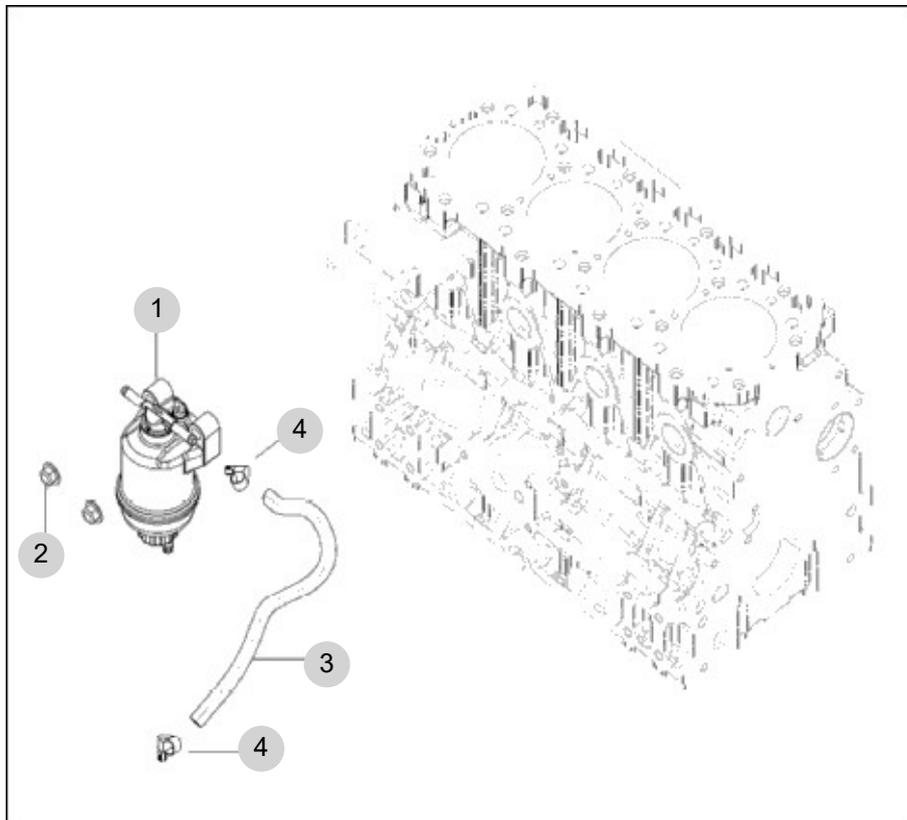

NOTE

FIG 139B

DPF SUPPORT (T494)

년/월
Year/Month

T494NH

2022-12

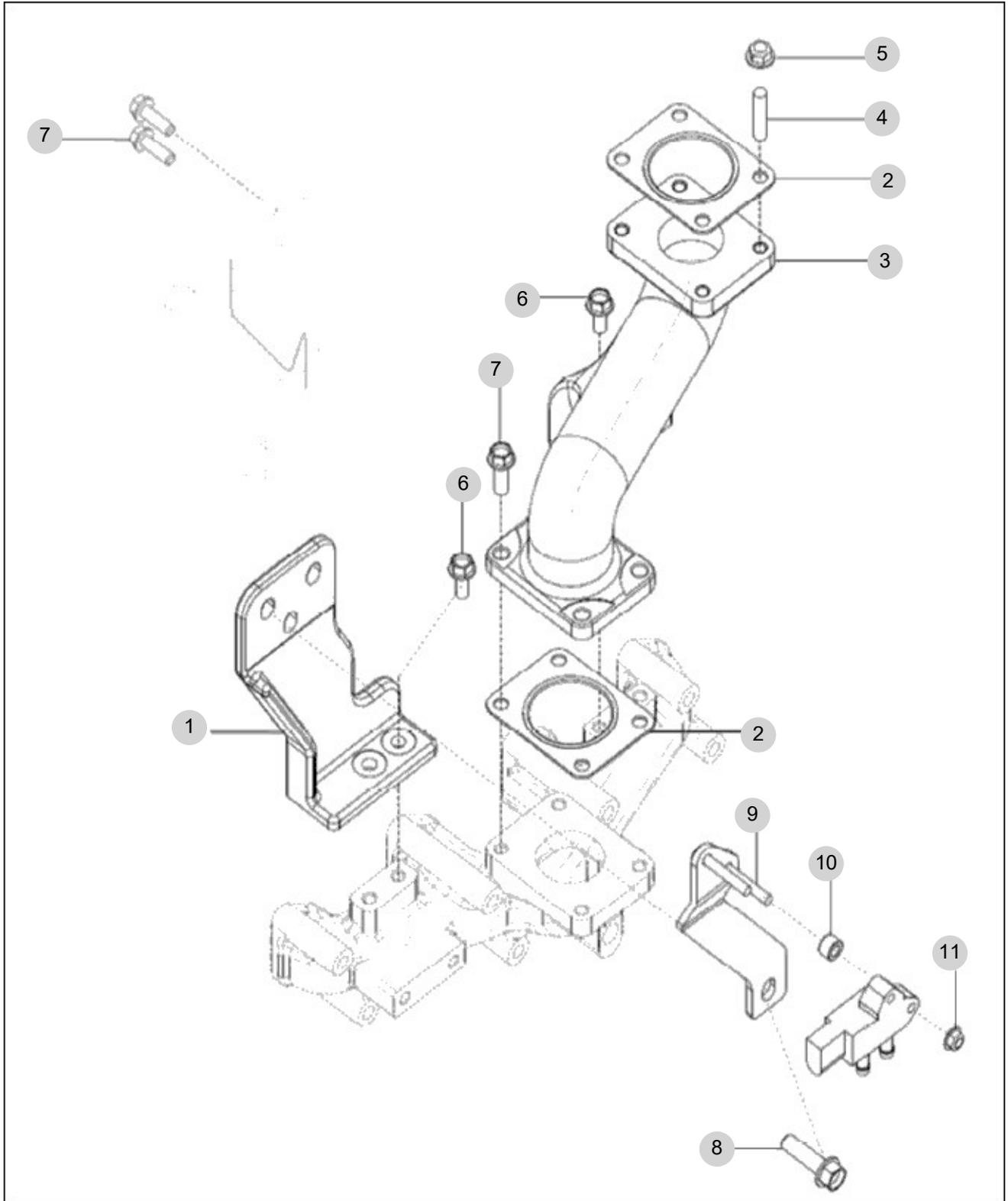

NOTE

FIG 140

T494NH

DATAPLATE

년/월
Year/Month

2022-12

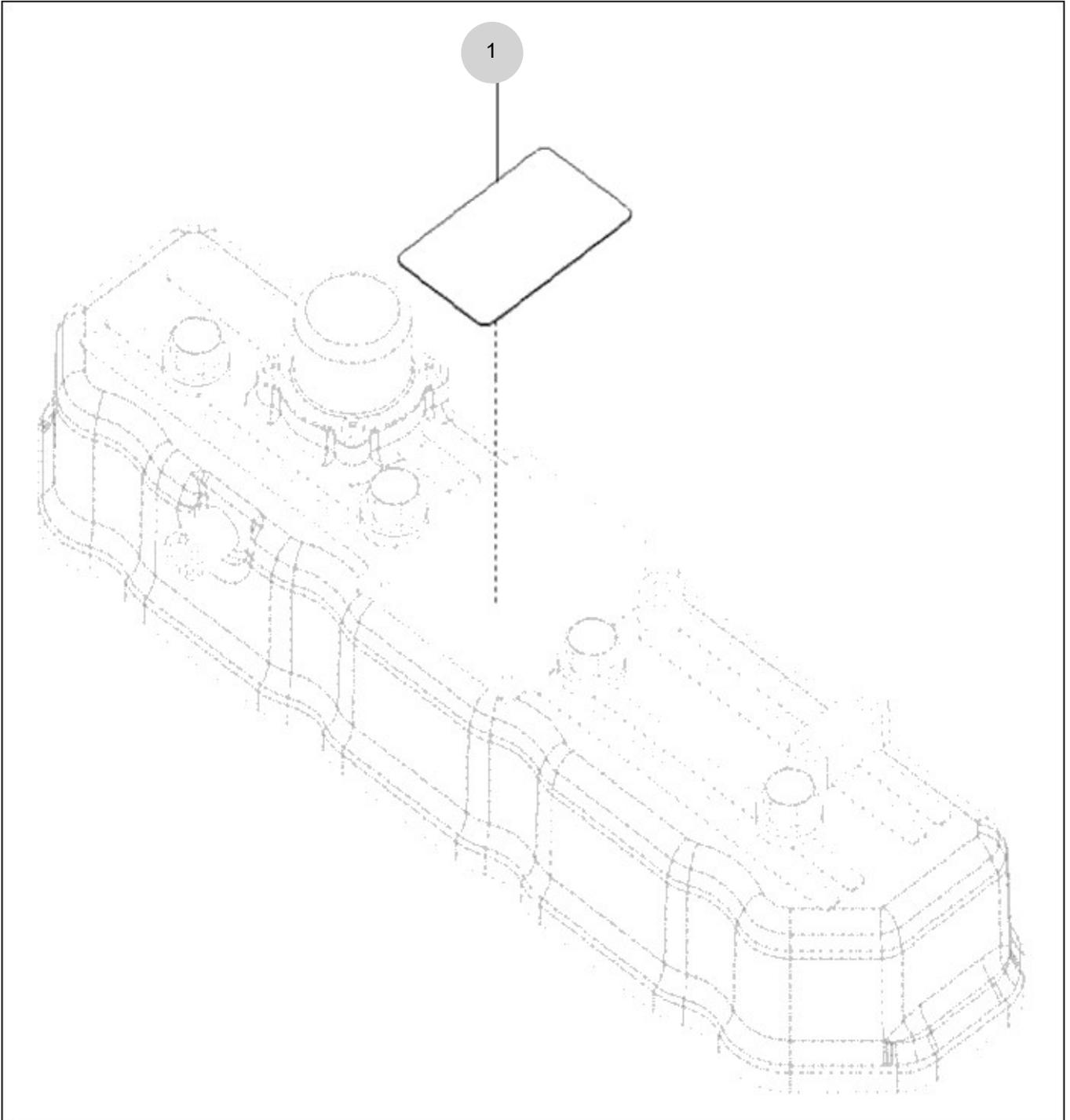

NOTE

FIG 142B

DPF ASS'Y (T494)

년/월
Year/Month

2022-12

T494NH

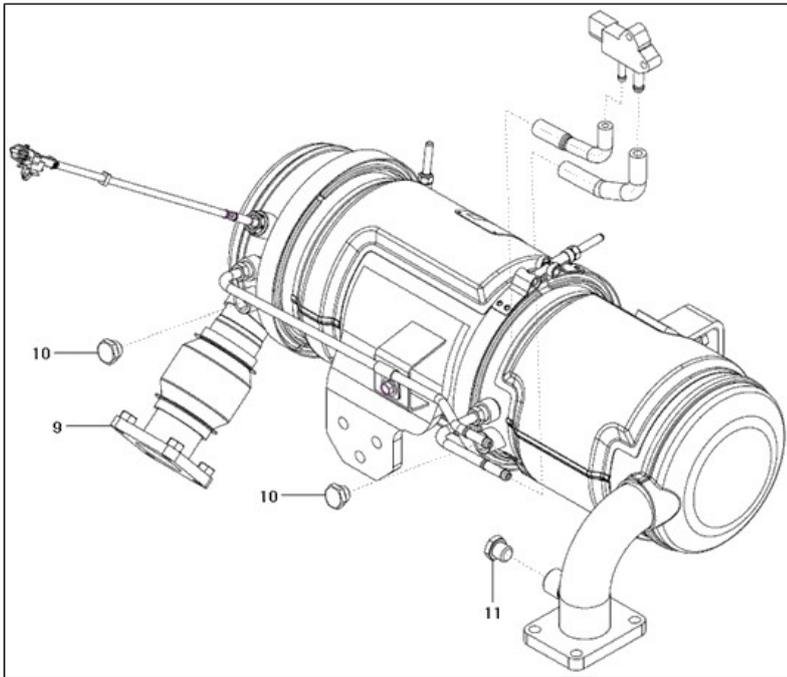
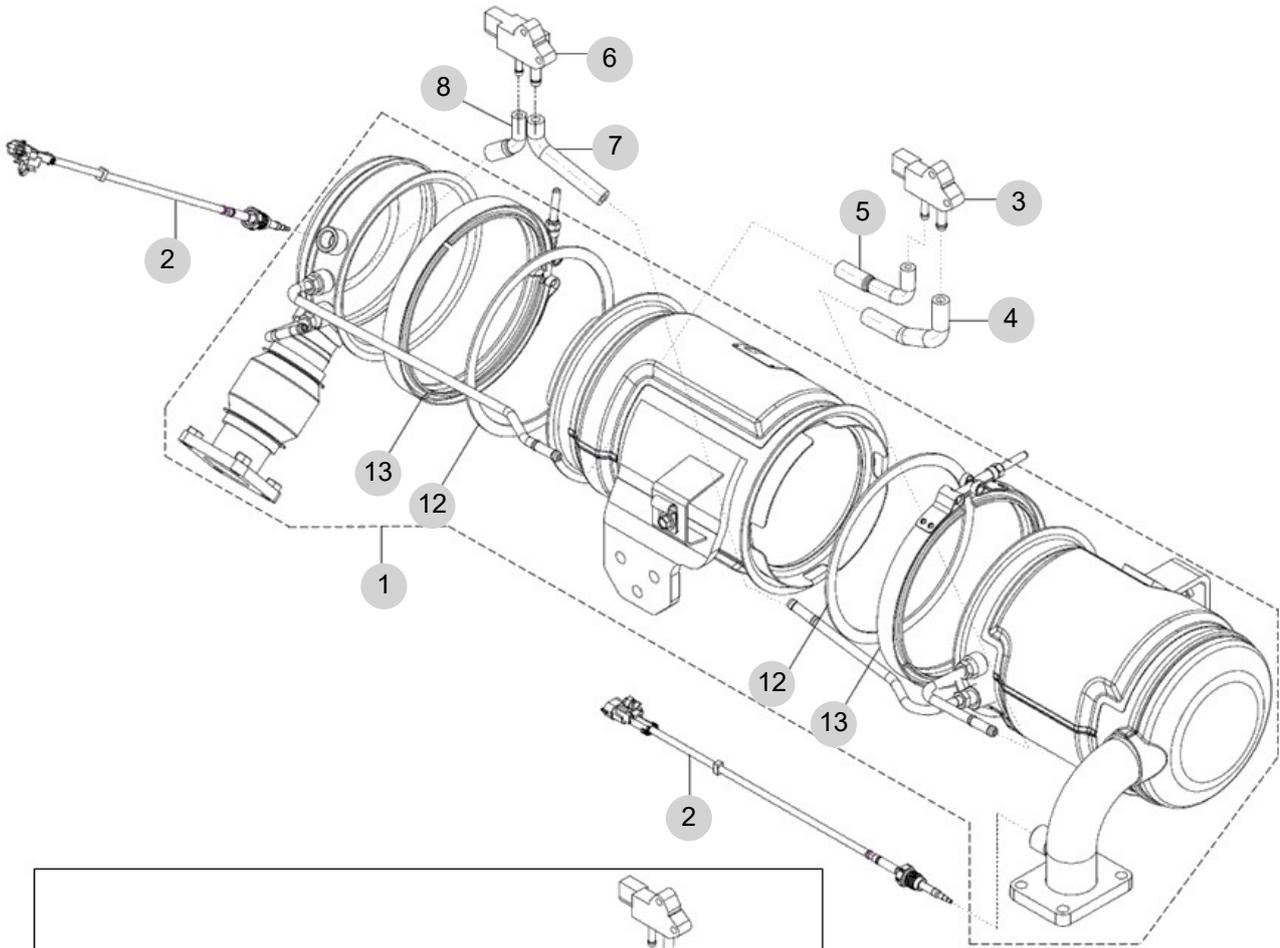

NOTE

FIG 143

T494NH

LIFT ASS'Y

년/월
Year/Month

2022-12

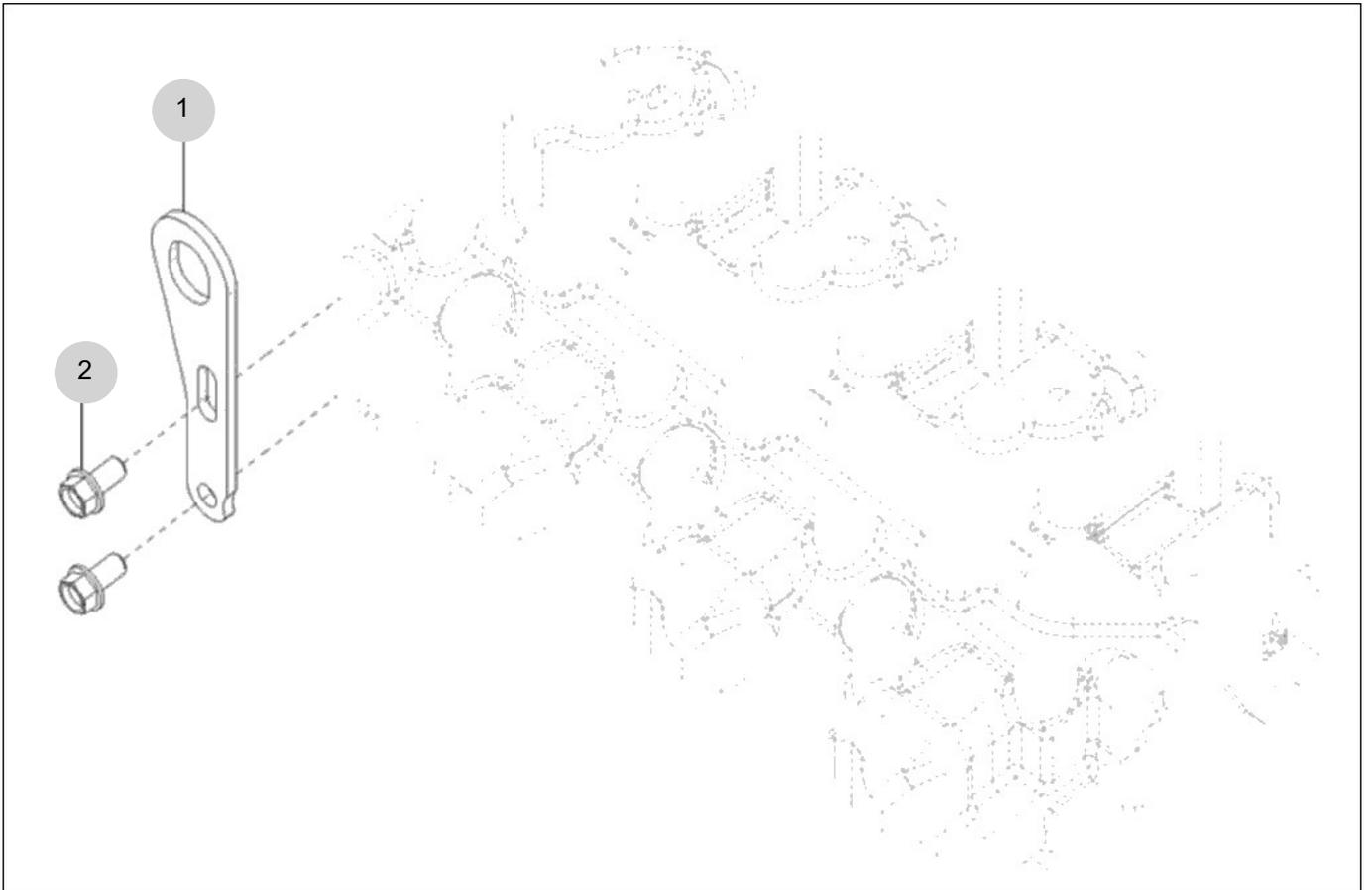

NOTE

FIG 144

T494NH

COMP . DRIVE PULLEY ASS'Y OPTION

년/월
Year/Month

2022-12

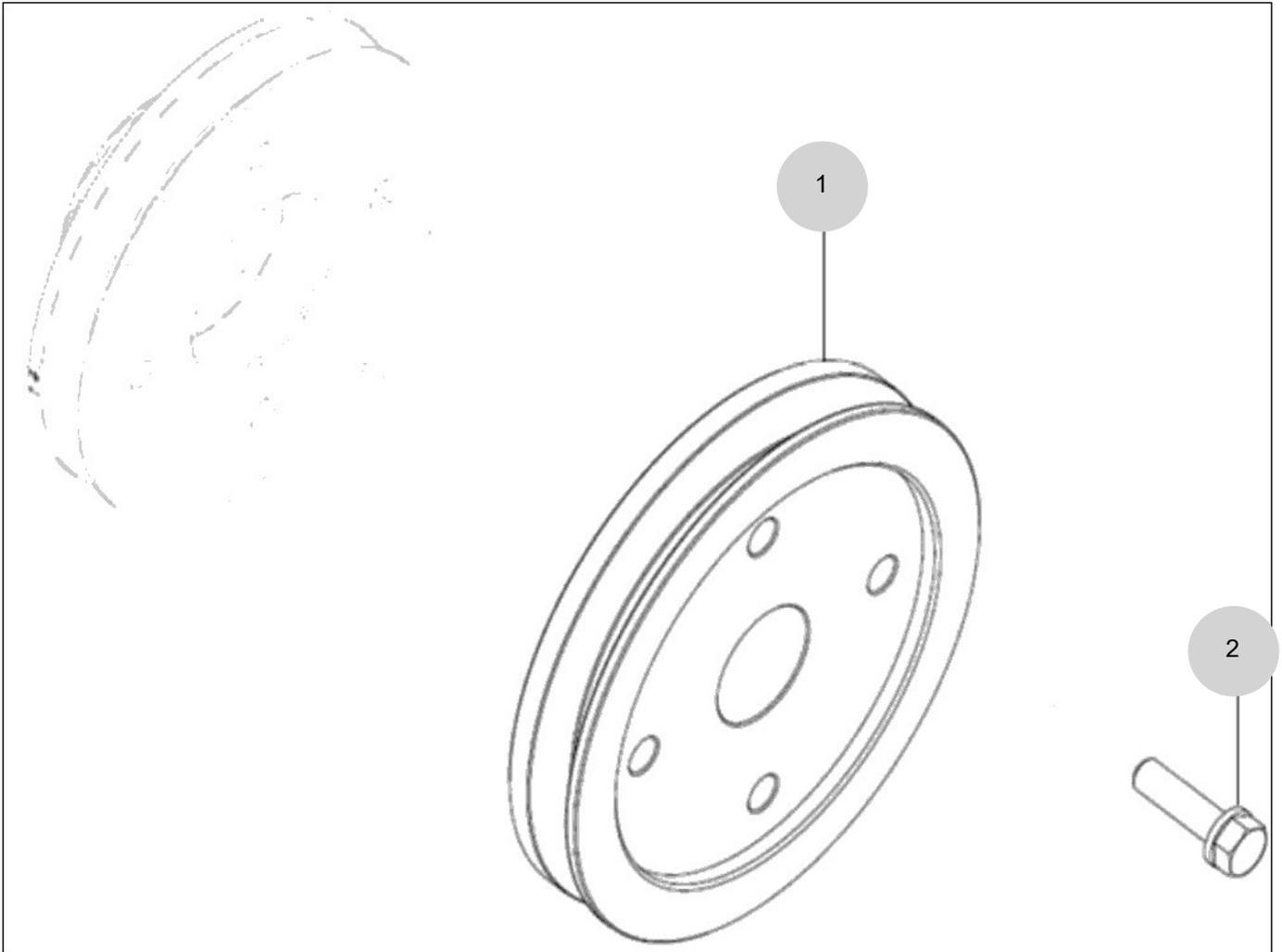

NOTE

FIG 147

T494NH

LOOSED PARTS

년/월
Year/Month

2022-12

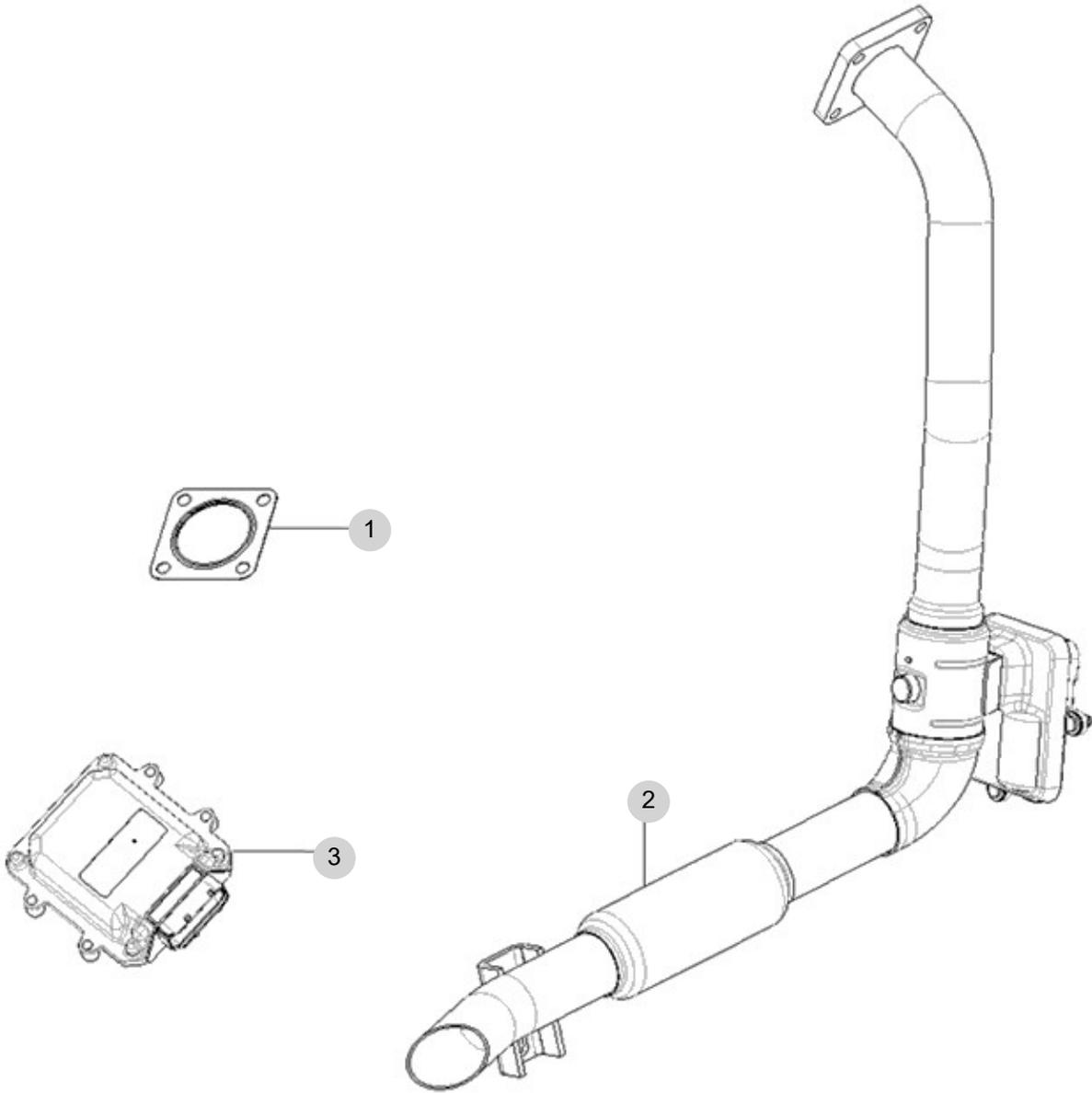

NOTE

2. Engine Accessories PART NO. T2

FIG 201B AIR CLEANER (T494)	104
FIG 202 RADIATOR	106
FIG 203 MUFFLER	108
FIG 204 FUEL HOSE & FILTER	110
FIG 205 FUEL TANK	112
FIG 206 ACCELERATOR	114
FIG 207 OIL COOLER	116

FIG 201B

AIR CLEANER (T494)

년/월
Year/Month

2022-12

T494NH

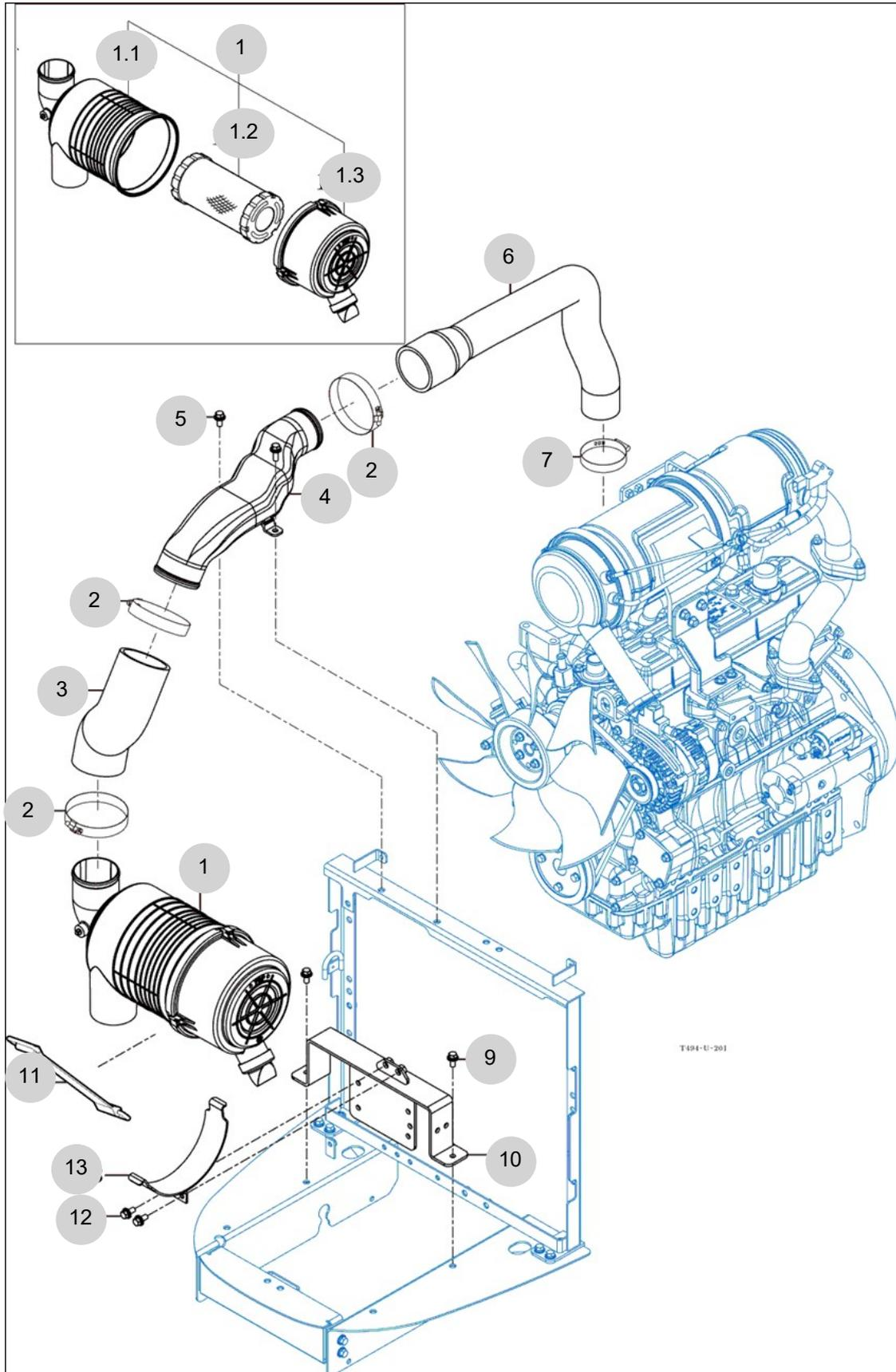

NOTE

FIG 202

RADIATOR

년/월
Year/Month

2022-12

T494NH

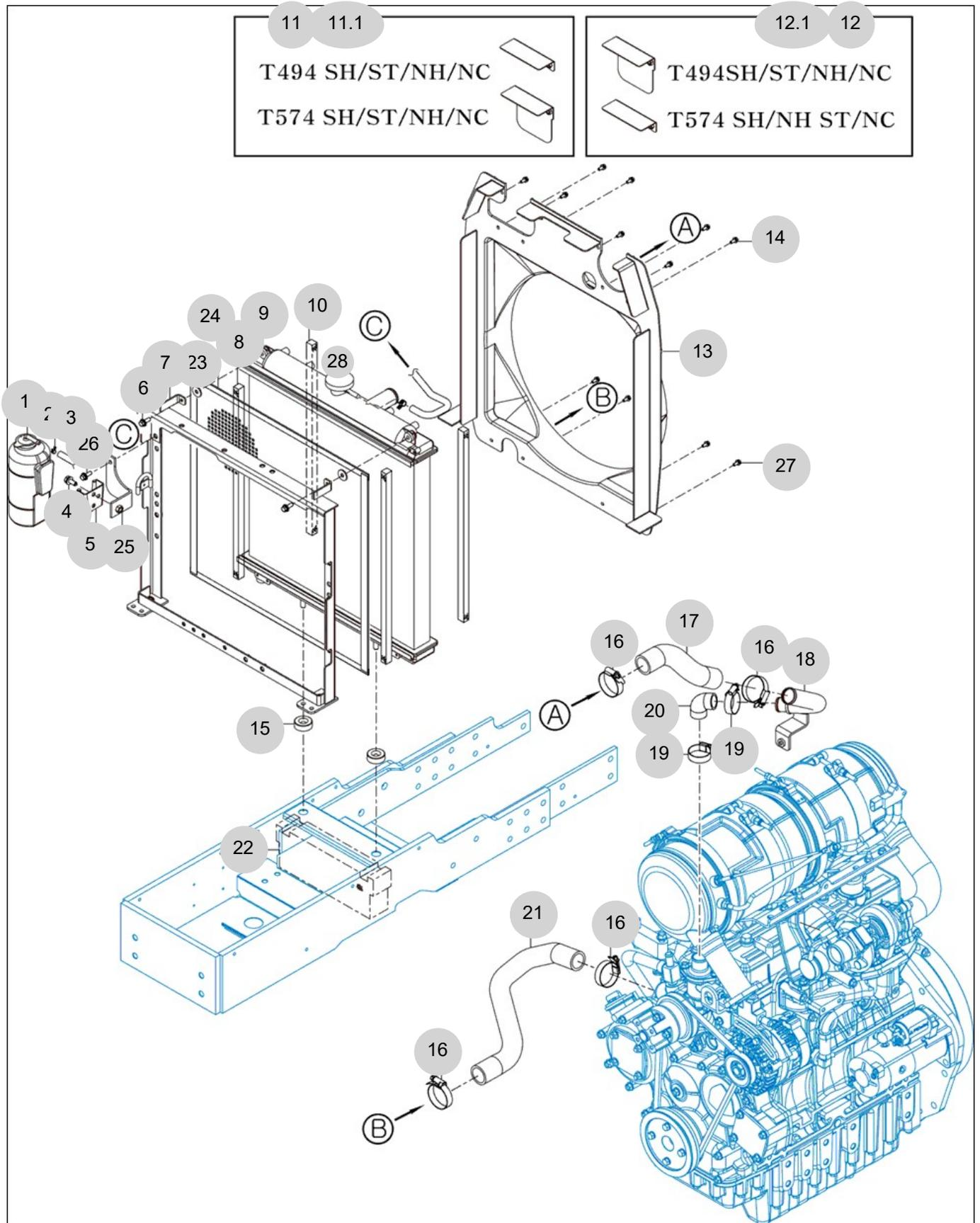

NOTE

FIG 203

MUFFLER

년/월
Year/Month

2022-12

T494NH

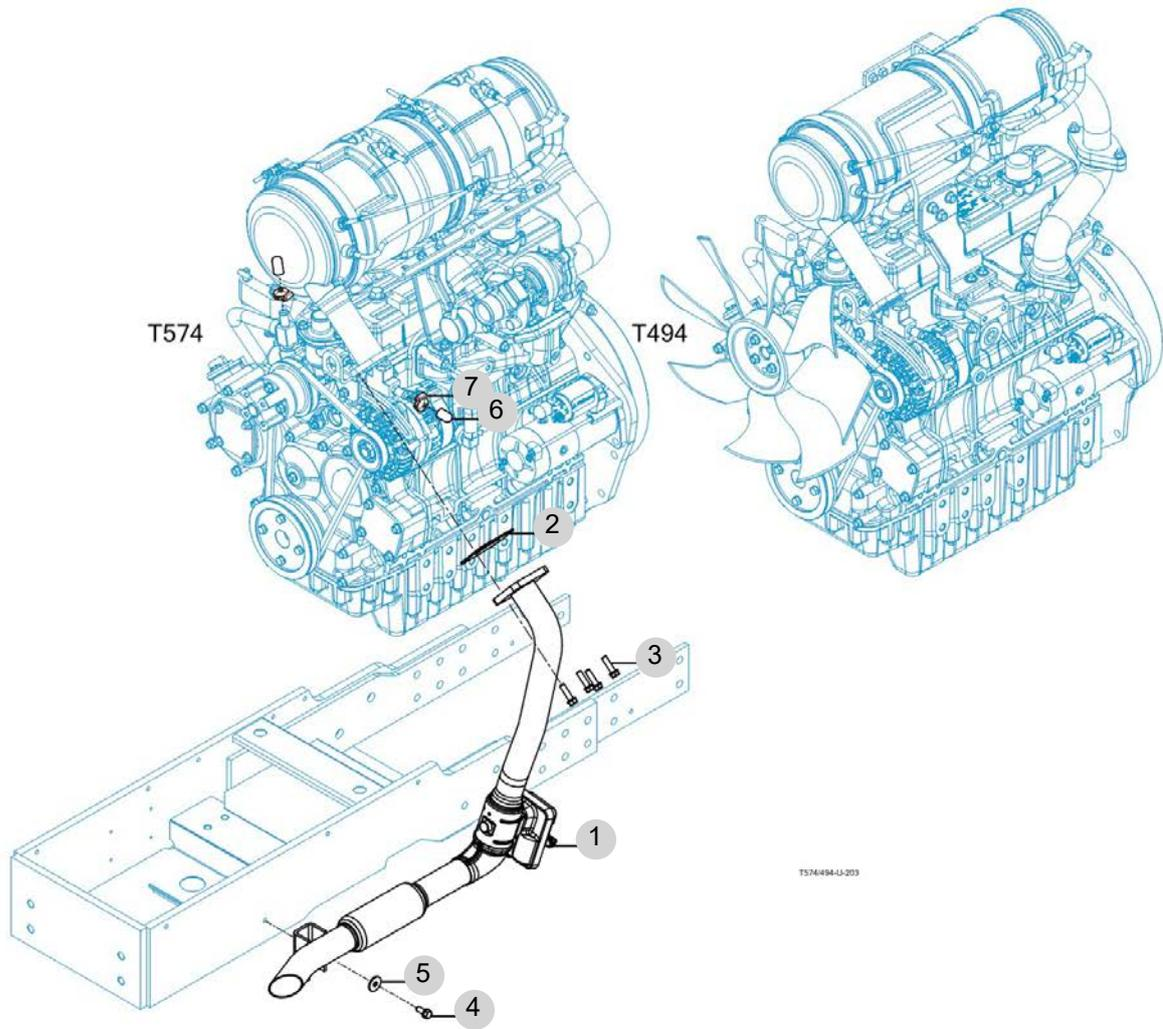

NOTE

FIG 204

FUEL HOSE & FILTER

년/월
Year/Month

2022-12

T494NH

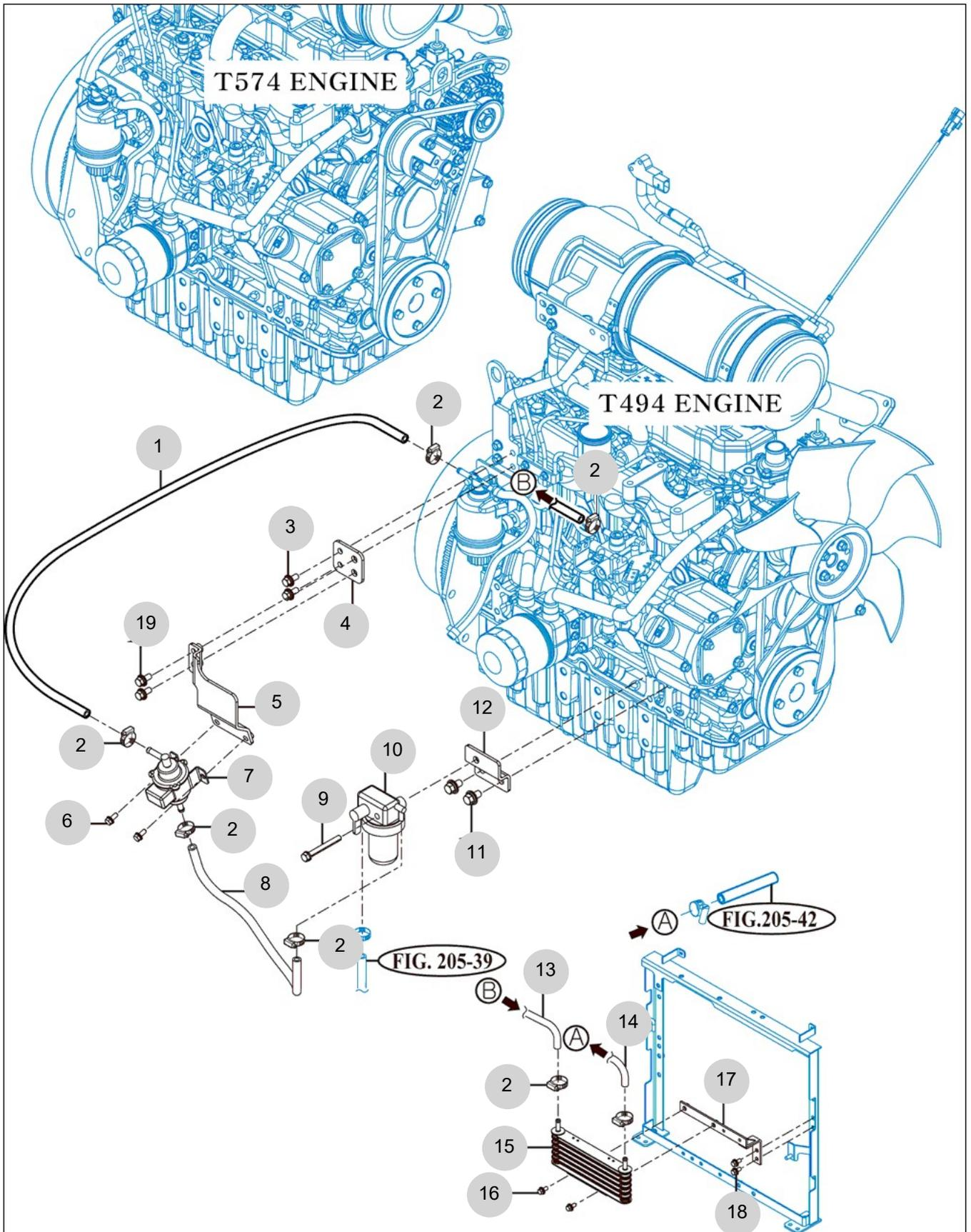

NOTE

FIG 205

T494NH

FUEL TANK

년/월
Year/Month

2022-12

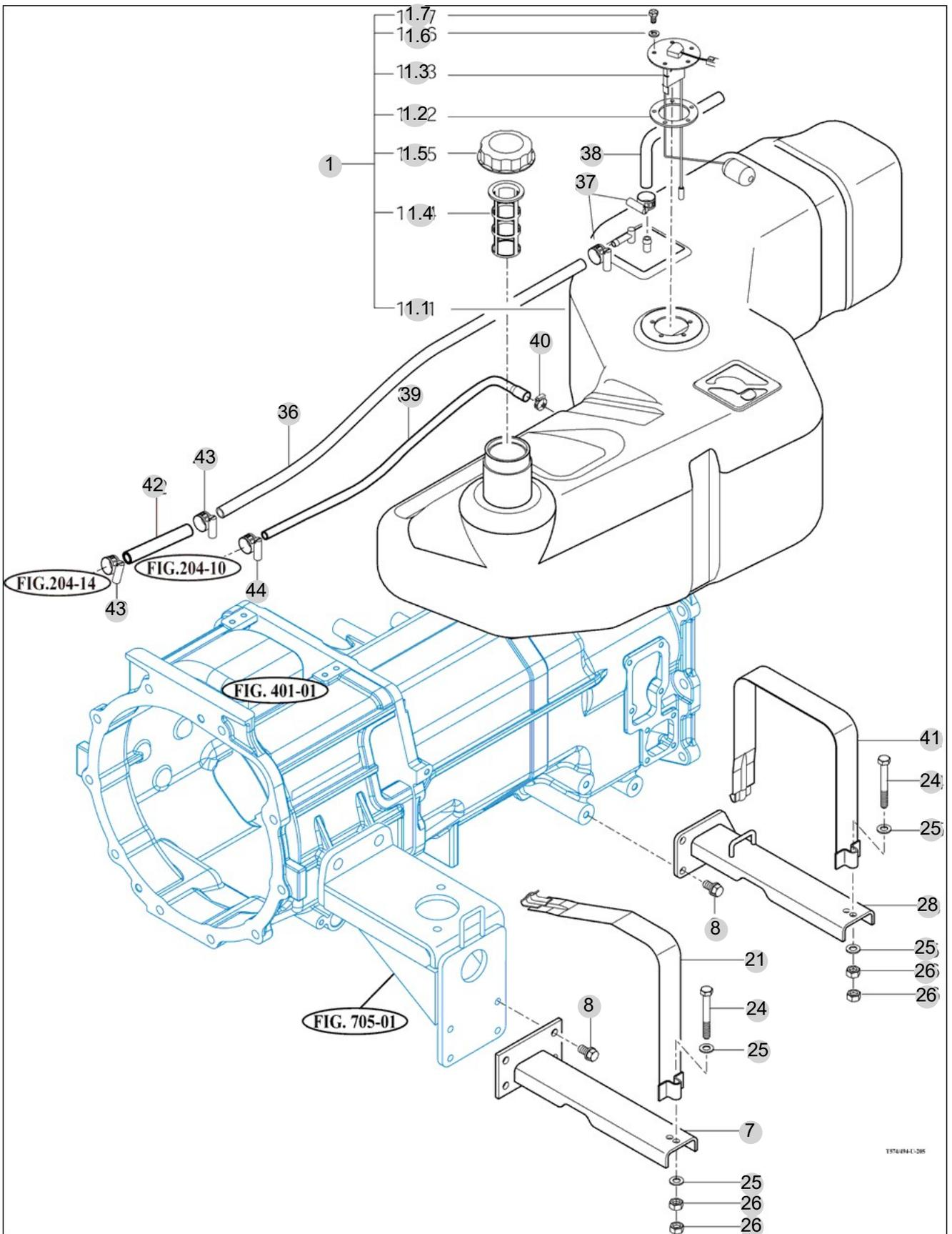

1574-094-L-205

NOTE

FIG 206

ACCELERATOR

년/월
Year/Month

T494NH

2022-12

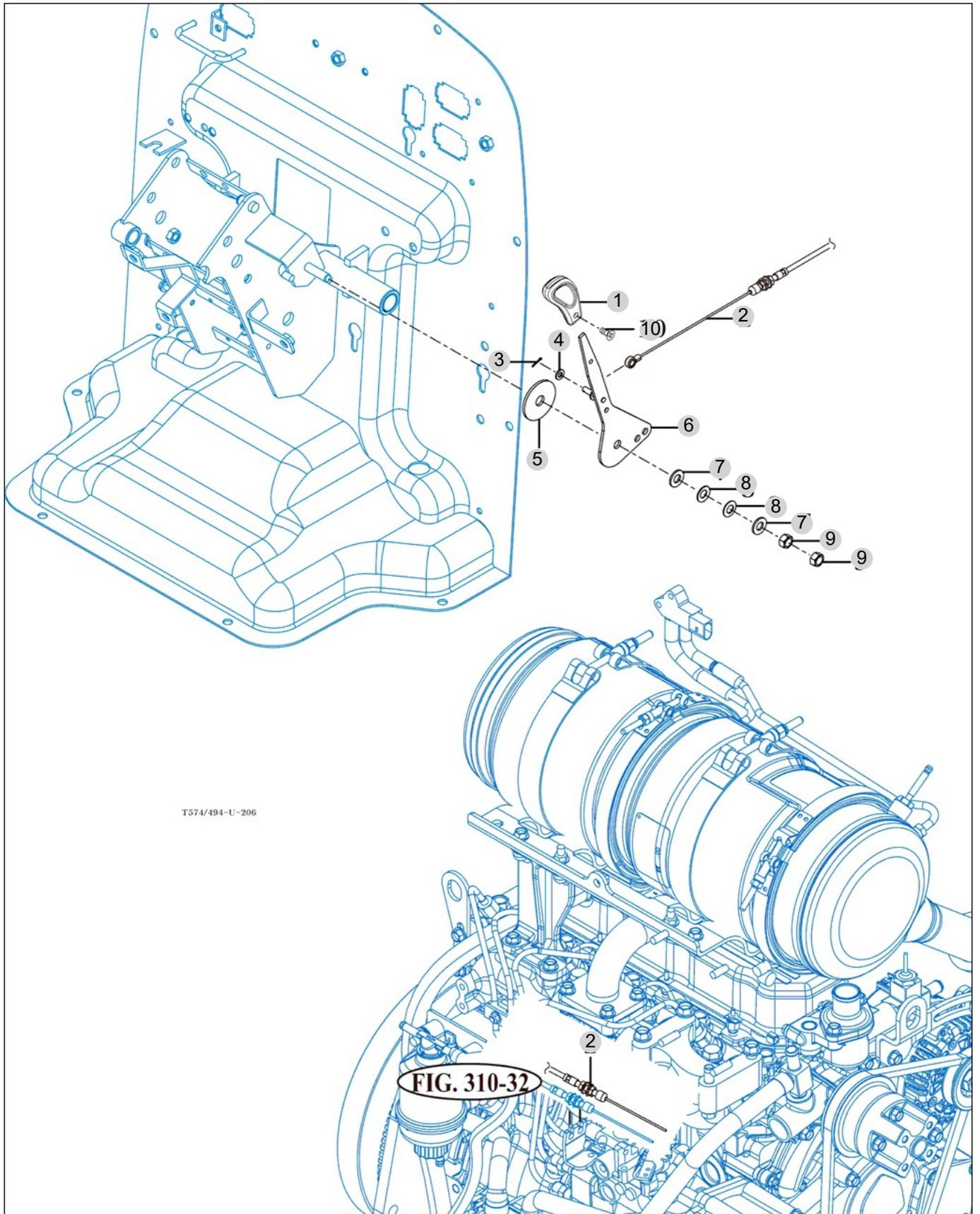

NOTE

FIG 207

OIL COOLER

년/월
Year/Month

T494NH

2022-12

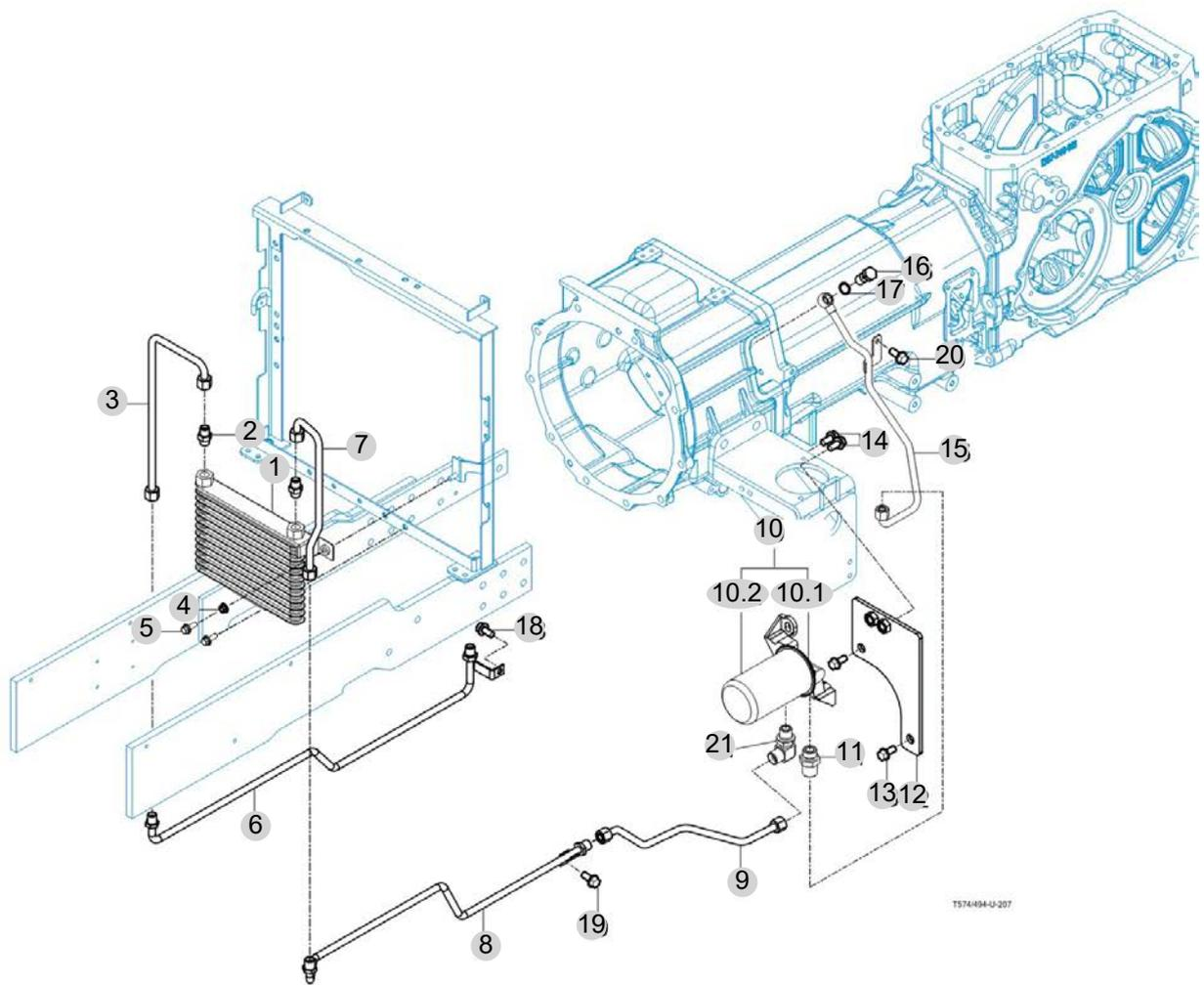

NOTE

3. Clutch/Brake/Steering PART NO. T3

FIG 301 FLYWHEEL HOUSING	119
FIG 302 CLUTCH PEDAL	121
FIG 303 BRAKE	123
FIG 304 BRAKE PEDAL & LINK	125
FIG 305 FRONT WHEEL	127
FIG 306 REAR WHEEL	129
FIG 307 POWER STEERING WHEEL	131
FIG 308 POWER STEERING VALVE	133
FIG 309 POWER STEERING CYLINDER	135
FIG 310 HST CONTROL LINK	137

FIG 301

FLYWHEEL HOUSING

년/월
Year/Month

2022-12

T494NH

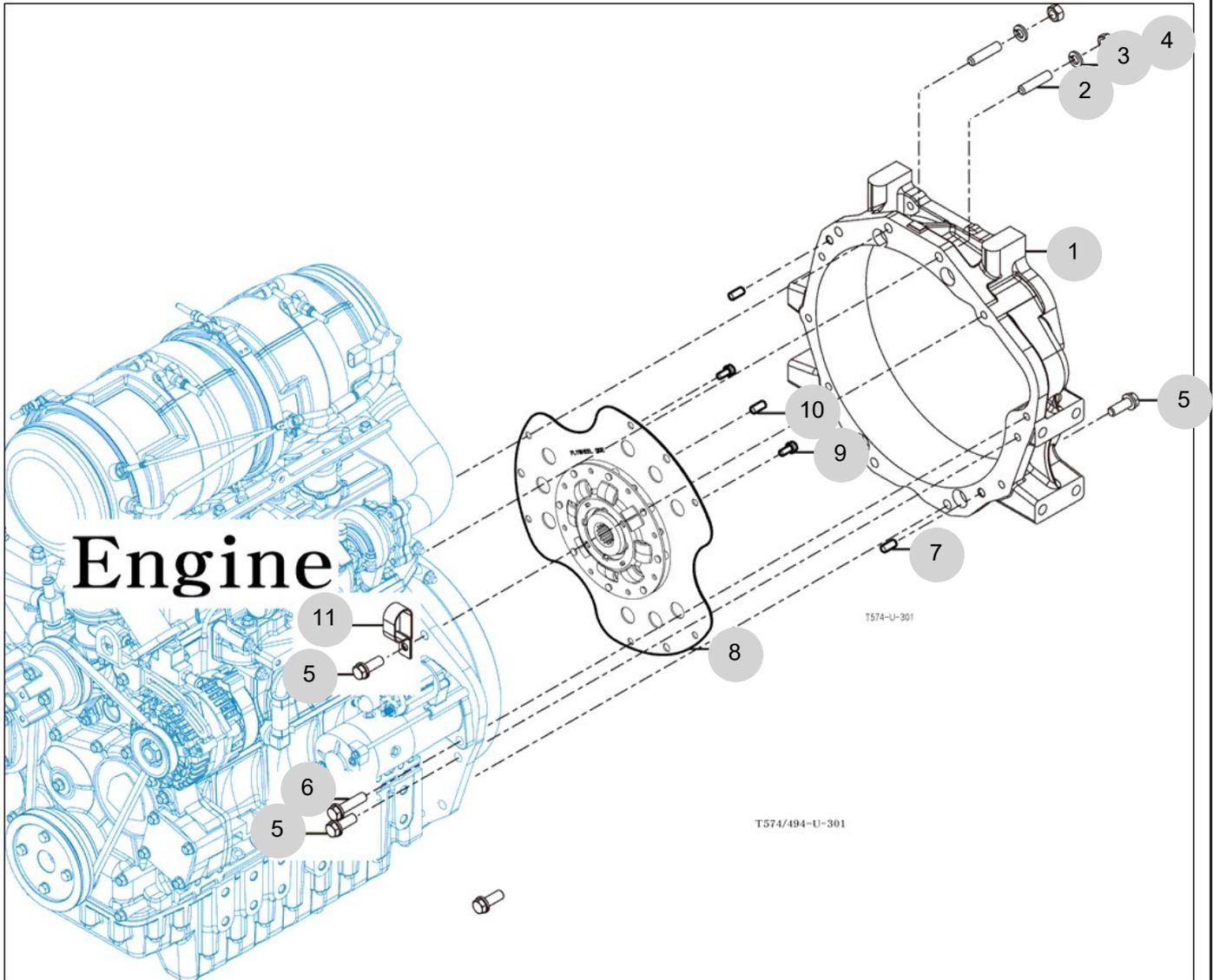

NOTE

FIG 302

CLUTCH PEDAL

년/월
Year/Month

2022-12

T494NH

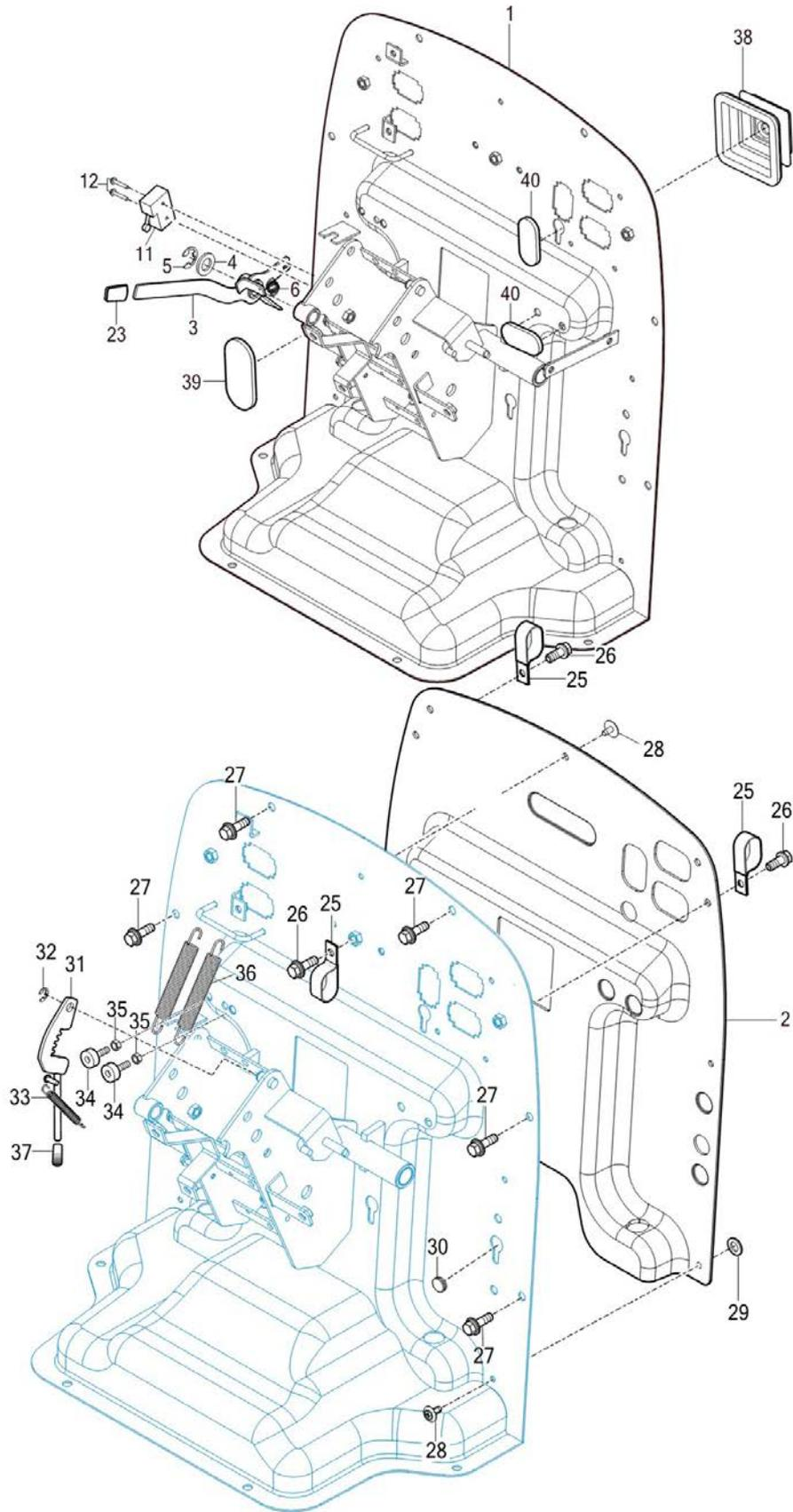

NOTE

FIG 304

BRAKE PEDAL & LINK

년/월
Year/Month

2022-12

T494NH

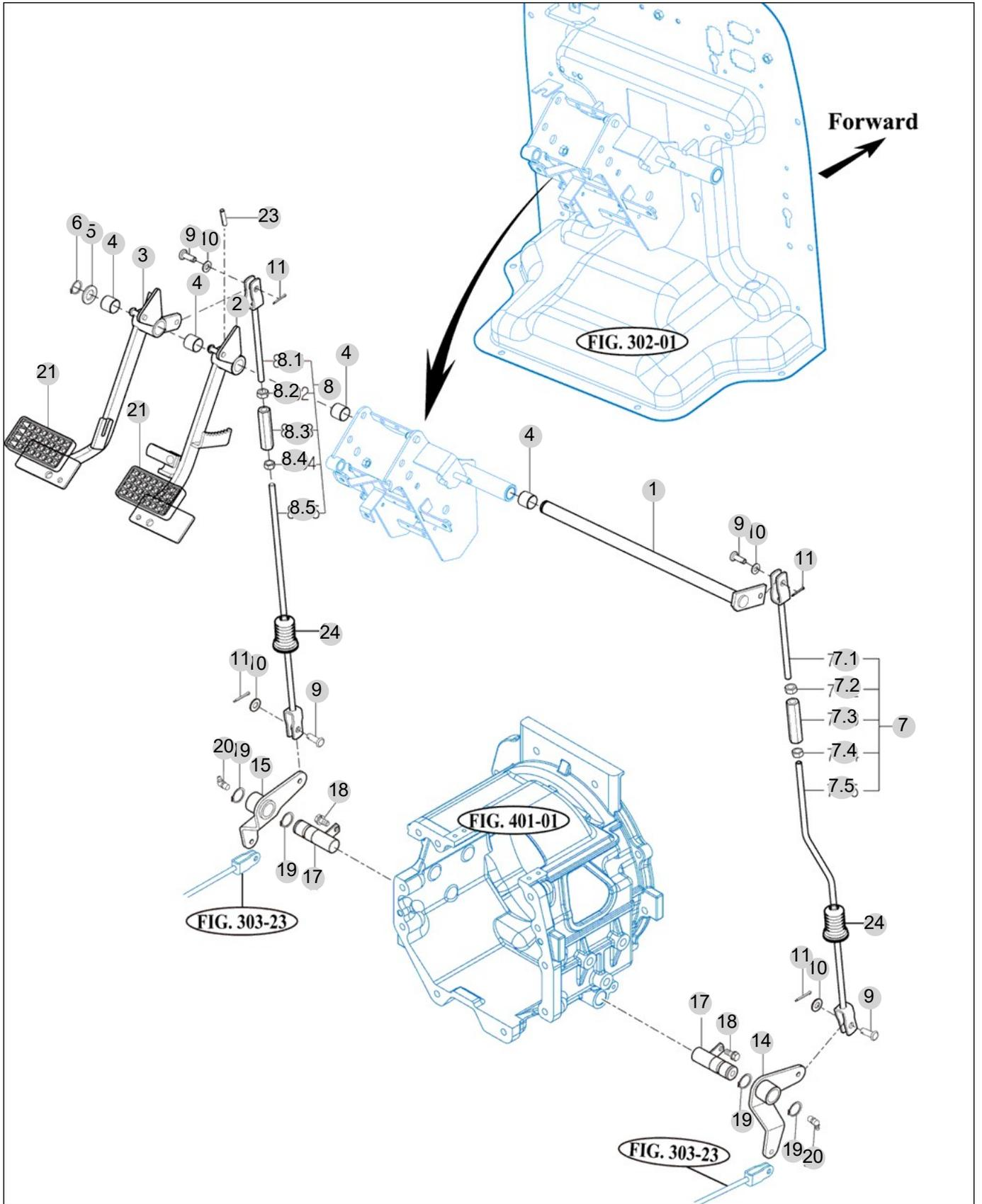

NOTE

FIG 305

T494NH

FRONT WHEEL

년/월
Year/Month

2022-12

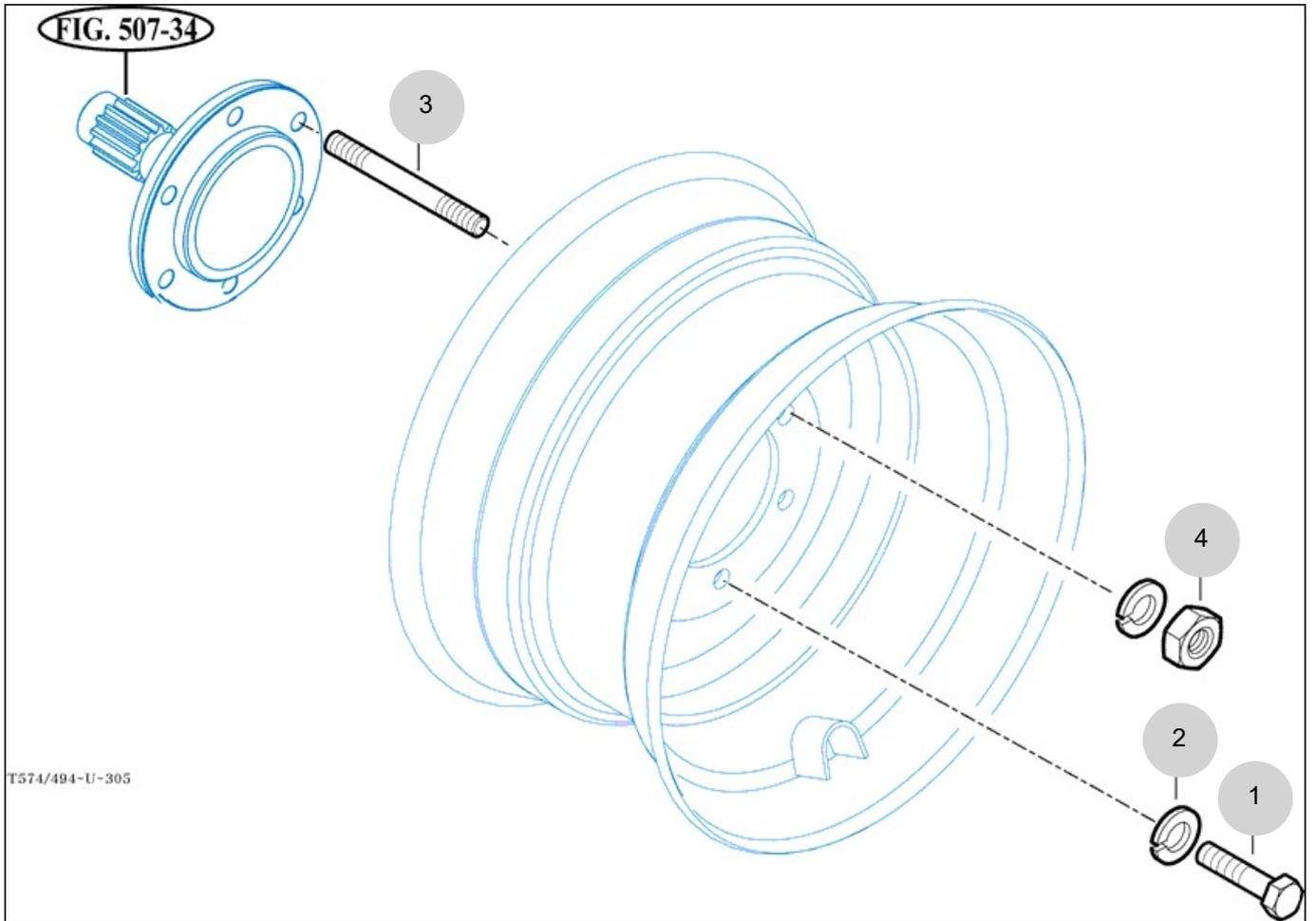

T574/494-U-305

NOTE

FIG 306

T494NH

REAR WHEEL

년/월
Year/Month

2022-12

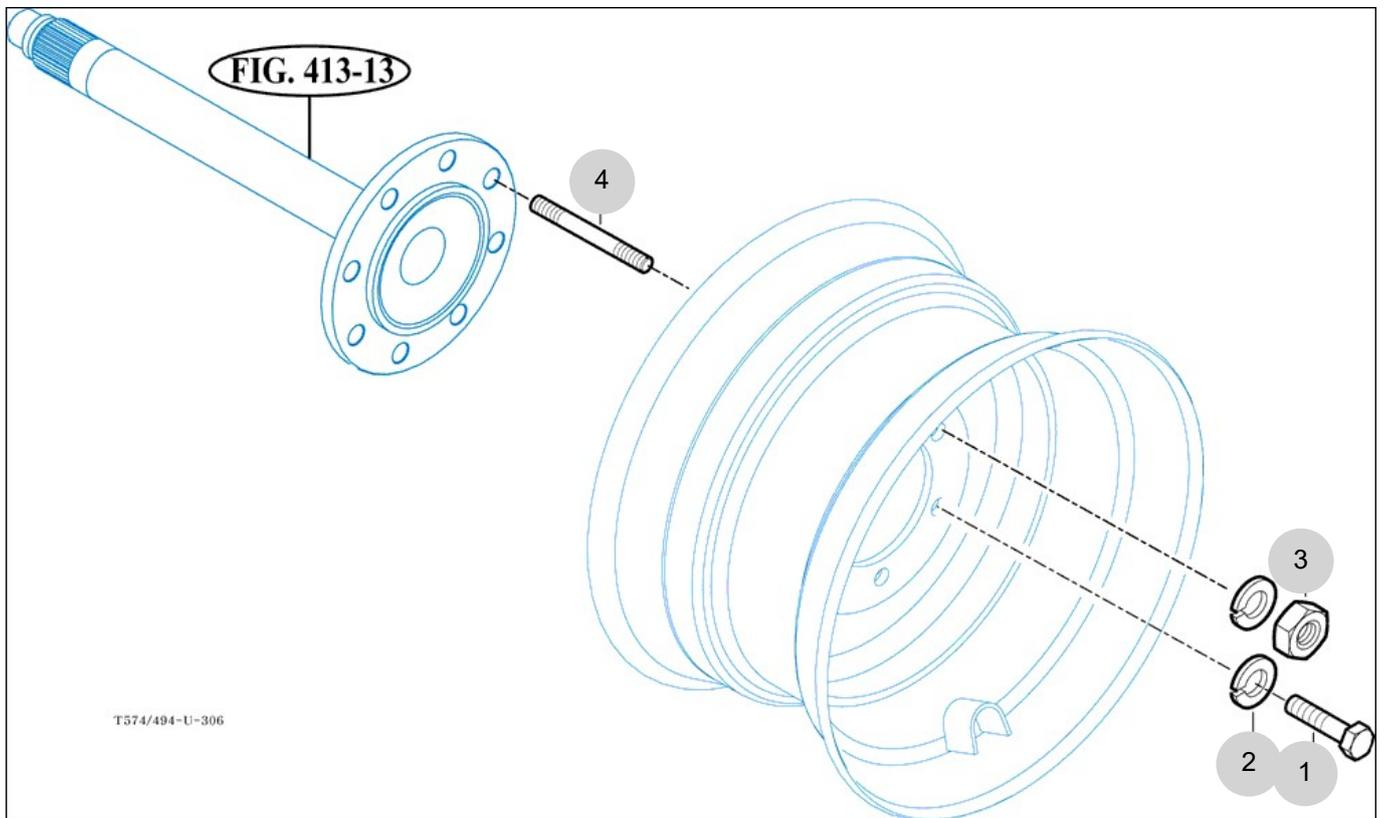

T574/494-U-306

NOTE

FIG 308

POWER STEERING VALVE

년/월
Year/Month

T494NH

2022-12

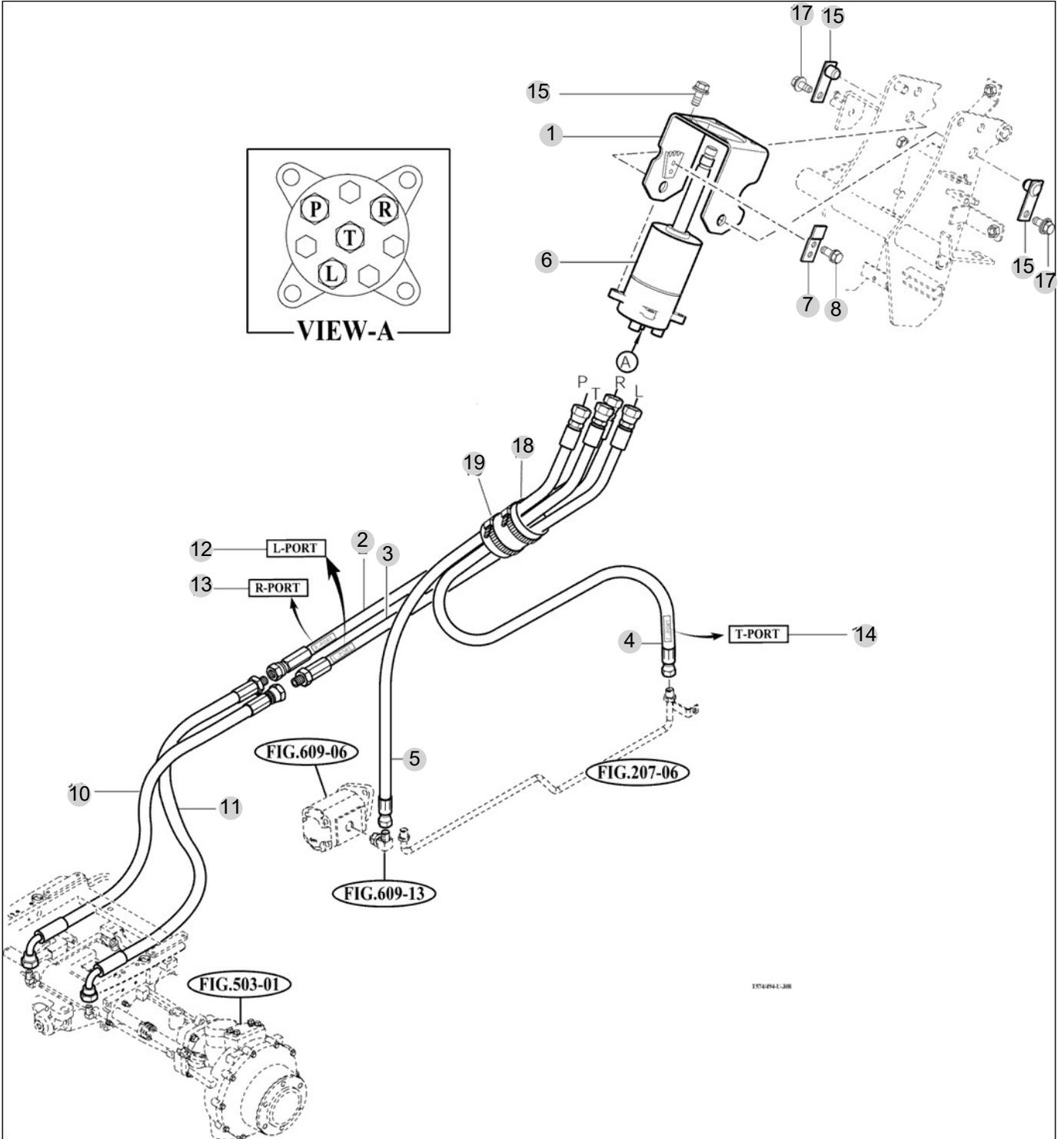

NOTE

FIG 309

T494NH

POWER STEERING CYLINDER

년/월
Year/Month

2022-12

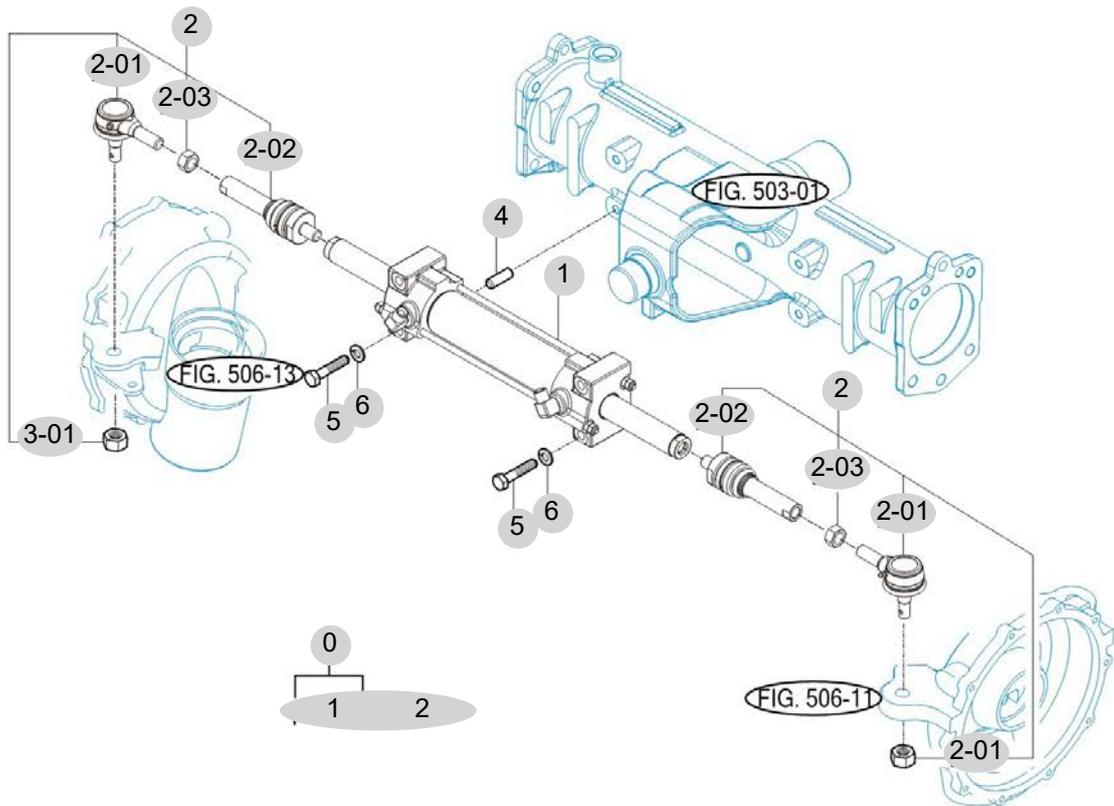

T55551/T494NH-E-309

NOTE

FIG 310

T494NH

HST CONTROL LINK

년/월
Year/Month

2022-12

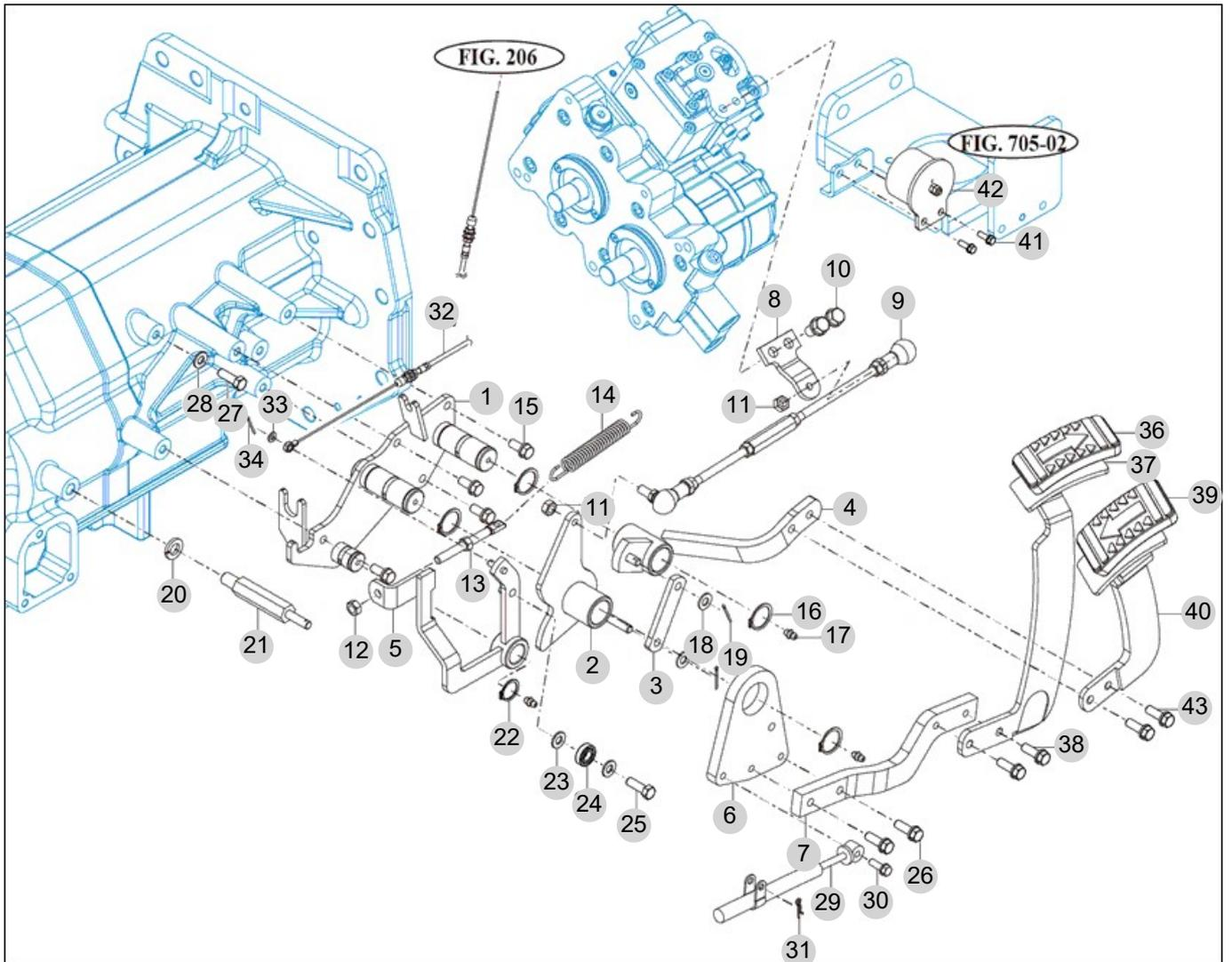

NOTE

FIG 310		HST CONTROL LINK					년/월	
							Year/Month	
T494NH		2022-12						
KEY NO	PART NO	DESCRIPTION	SPEC	QTY	REPAIR	EFFECTIVE DATE	REMARKS	
310	1	13872313200	BRACKET COMP, HST PEDAL			1		
310	2	13872312300	ARM COMP, FORWARD			1		
310	3	14722310023	PLATE , REVERSE	19X6		1		
310	4	13872312600	ARM COMP, REVERSE			1		
310	5	13872312501	ARM COMP, CAM FOLLOWER			1		
310	6	13872312330	PLATE, CONTROL			1		
310	7	13872310050	PLATE, FORWARD			1		
310	8	13872312110	ARM PLATE, HST			1		
310	8	13872312111	ARM PLATE, HST			1		
310	8	13872312112	ARM PLATE, HST			1		
310	9	13872325000	ROD ASSY, HST			1		
310	9	13872325001	ROD ASSY, HST			1		
310	9	13872325002	ROD ASSY, HST			1		
310	10	V2143610020	BOLT , HEX FINE /S	M10X20		2		
310	11	V3013600080	NUT .HEX NORMAL /2	M8		2		
310	12	V3043600080	NUT , HEX/2	M8		1		
310	13	34522150080	ROD , CHAIN(TENSION)(82)	D=8		1		
310	14	14722310033	SPRING , RETURN	D=2.4		1		
310	15	V2173608020	BOLT , HEX/S	M8X20		4		
310	16	V7041400250	C-RING , SHAFT	25		4		
310	17	V7601500000	NIPPLE , GREASE/A-M6F			3		
310	18	V4111600080	WASHER , PLAIN	M8		2		
310	19	V5001920020	PIN , SPLIT	2X20		2		
310	20	V4011600120	WASHER , SPRING	M12		1		
310	21	14722310041	PIN , OIL DAMPER	B=17		1		
310	22	V7041400200	C-RING , SHAFT	20		1		
310	23	V4111600080	WASHER , PLAIN	M8		2		
310	24	14722310060	BEARING , BALL			1		
310	25	V2013608025	BOLT , HEX	M8X25		1		
310	26	V2173608025	BOLT , HEX/S	M8X25		2		
310	27	V2013608045	BOLT , HEX	M8X45		1		
310	28	V3042600080	NUT , HEX/2	M8		1		
310	29	14722312401	DAMPER , OIL	1X1X1		1		
310	30	V2183608030	BOLT , HEX/SP	M8X30		1		
310	31	V5601600008	PIN , SNAP	8		1		
310	32	13871162700	CABLE ASSY, AUTO THROTTLE			1		
310	33	V4111600060	WASHER , PLAIN	M6		1		
310	34	V5001920015	PIN , SPLIT	2X15		1		
310	36	14722312730	PAD	1X1X1		1		
310	37	13872312700GB	PEDAL COMP, FORWARD			1		
310	38	V2173608020	BOLT , HEX/S	M8X20		2		
310	39	14722312730	PAD	1X1X1		1		
310	40	13872312800GB	PEDAL COMP, REVERSE			1		
310	40	13872312801GB	PEDAL COMP, REVERSE			1		
310	41	V2173608020	BOLT , HEX/S	M8X20		2		
NOTE								

4. Transmission PART NO. T4

FIG 401 TRANSMISSION FRONT CASE	141
FIG 402 HST	143
FIG 403 MID TRANSMISSION CASE	145
FIG 404 TRANSTER GEAR SET	147
FIG 405 TRANSMISSION REAR CASE	149
FIG 406 SUB CHANGE GEARS	151
FIG 407 SUB CHANGE SHIFTER	153
FIG 408 DRIVE GEARS	155
FIG 409 4WD CHANGE LEVER	157
FIG 410 P.T.O DRIVE SHAFT	159
FIG 411 P.T.O CHANGE GEARS	161
FIG 412 REAR DIFFERENTIAL GEARS	163
FIG 413 REAR AXLE HOUSING	166

FIG 401

T494NH

TRANSMISSION FRONT CASE

년/월
Year/Month

2022-12

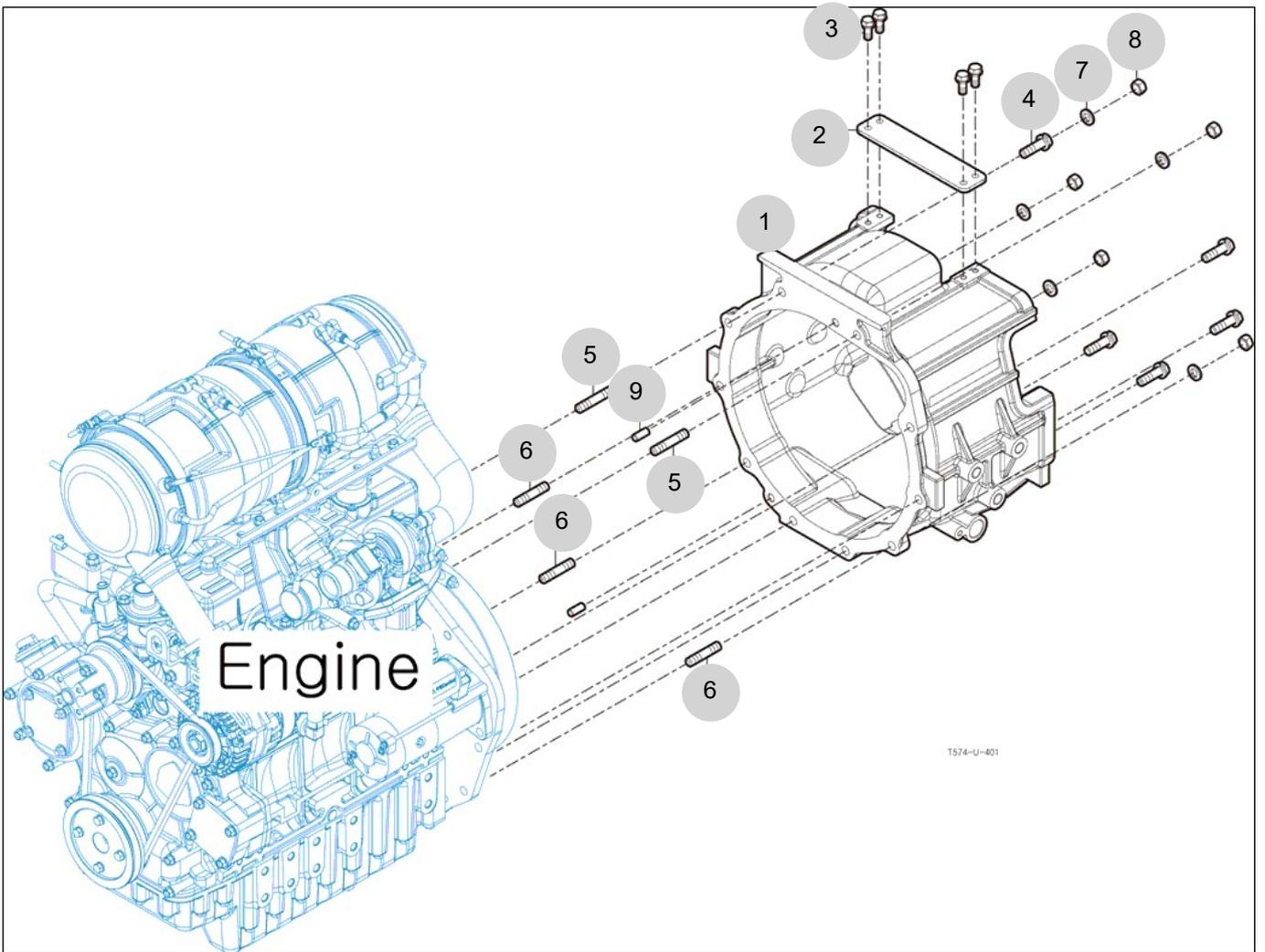

NOTE

FIG 402

T494NH

HST

년/월
Year/Month

2022-12

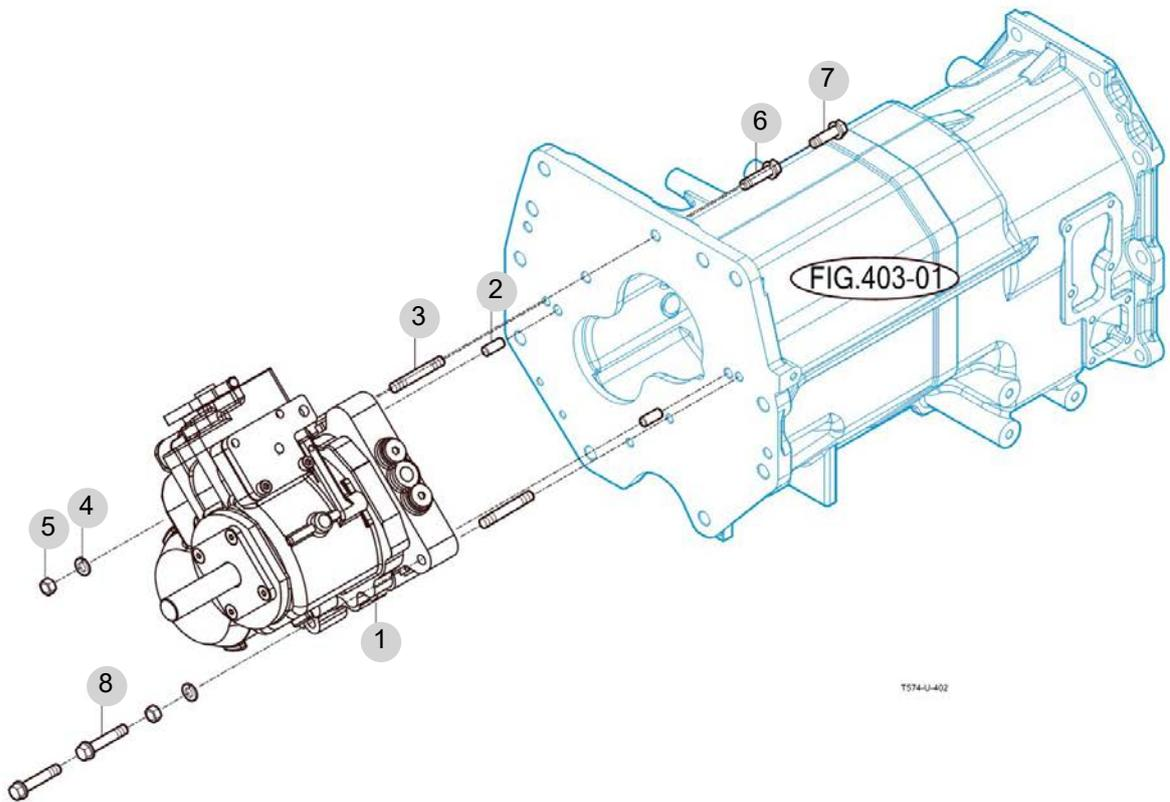

T574-U-402

NOTE

FIG 403

T494NH

MID TRANSMISSION CASE

년/월
Year/Month

2022-12

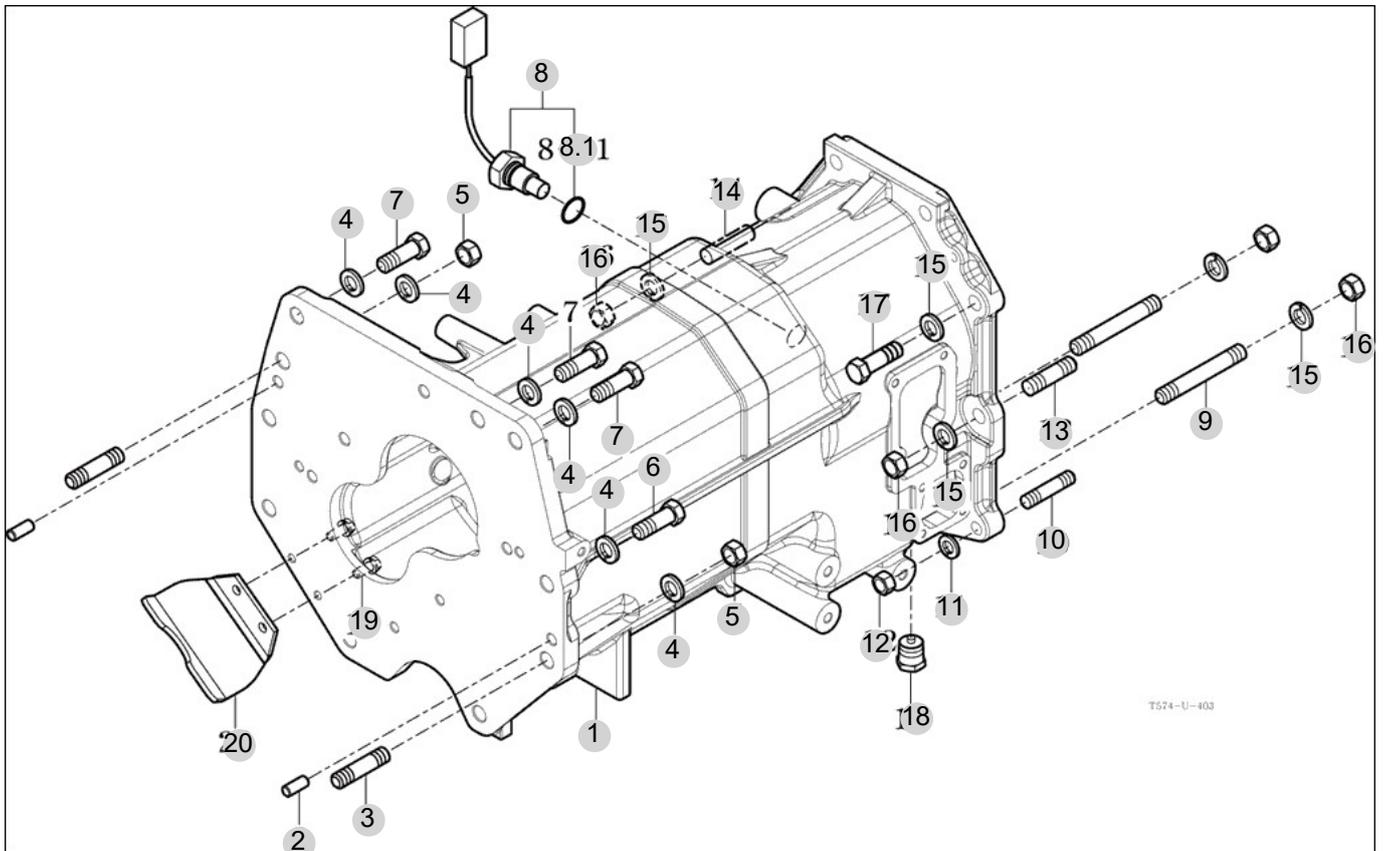

NOTE

FIG 404

T494NH

TRANSFER GEAR SET

년/월
Year/Month

2022-12

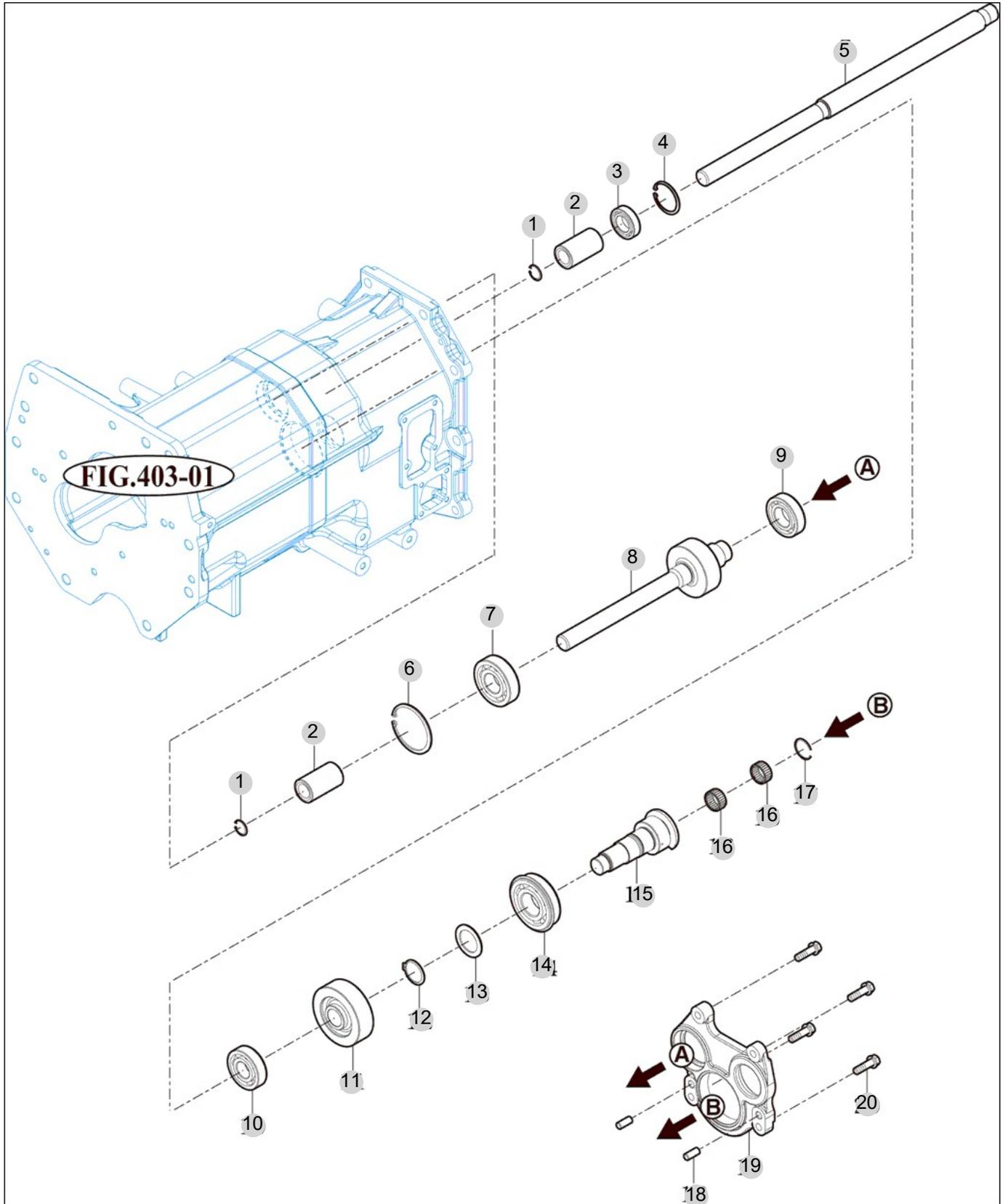

NOTE

FIG 405

TRANSMISSION REAR CASE

년/월
Year/Month

2022-12

T494NH

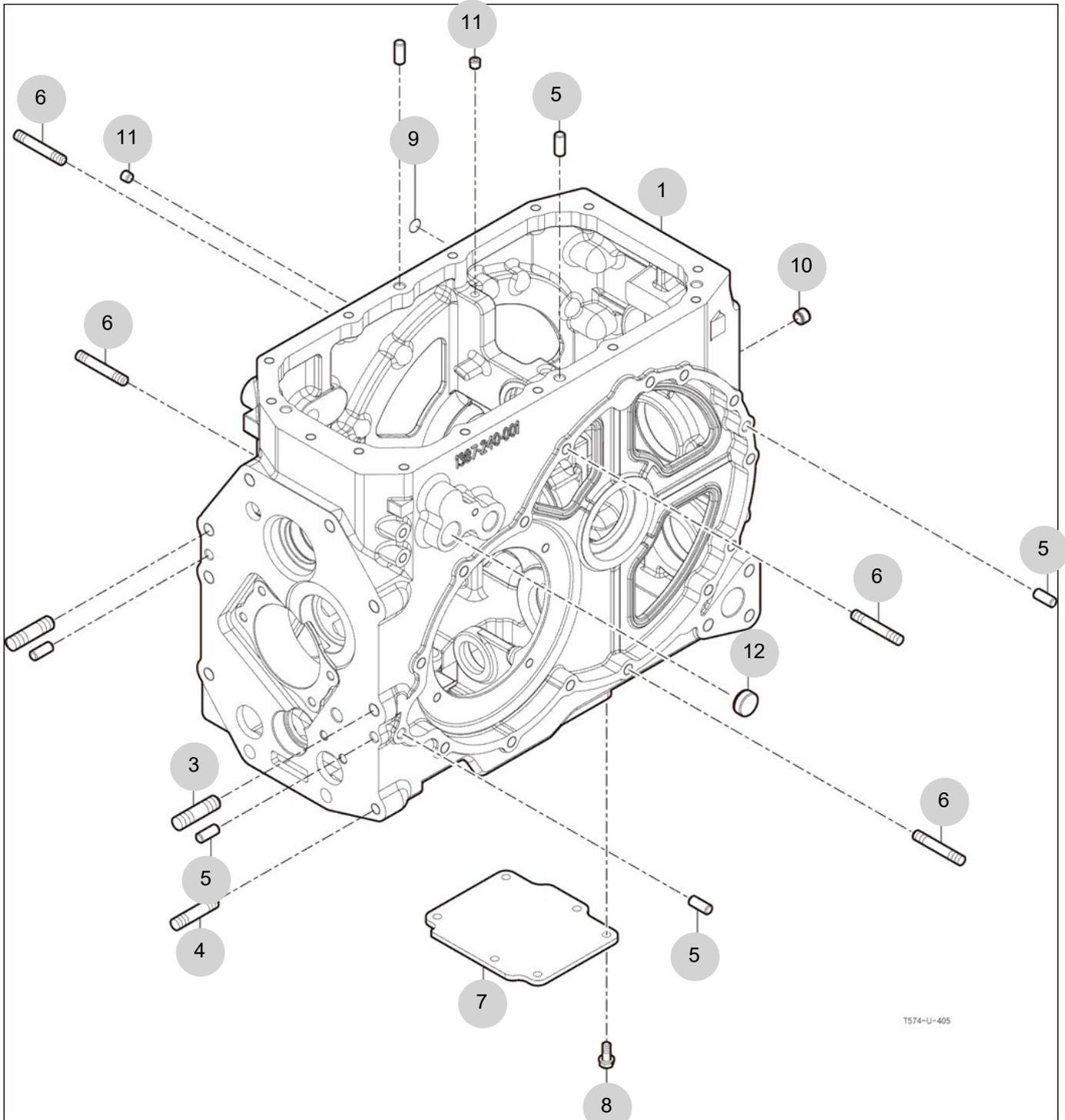

NOTE

FIG 406

SUB CHANGE GEARS

년/월
Year/Month

T494NH

2022-12

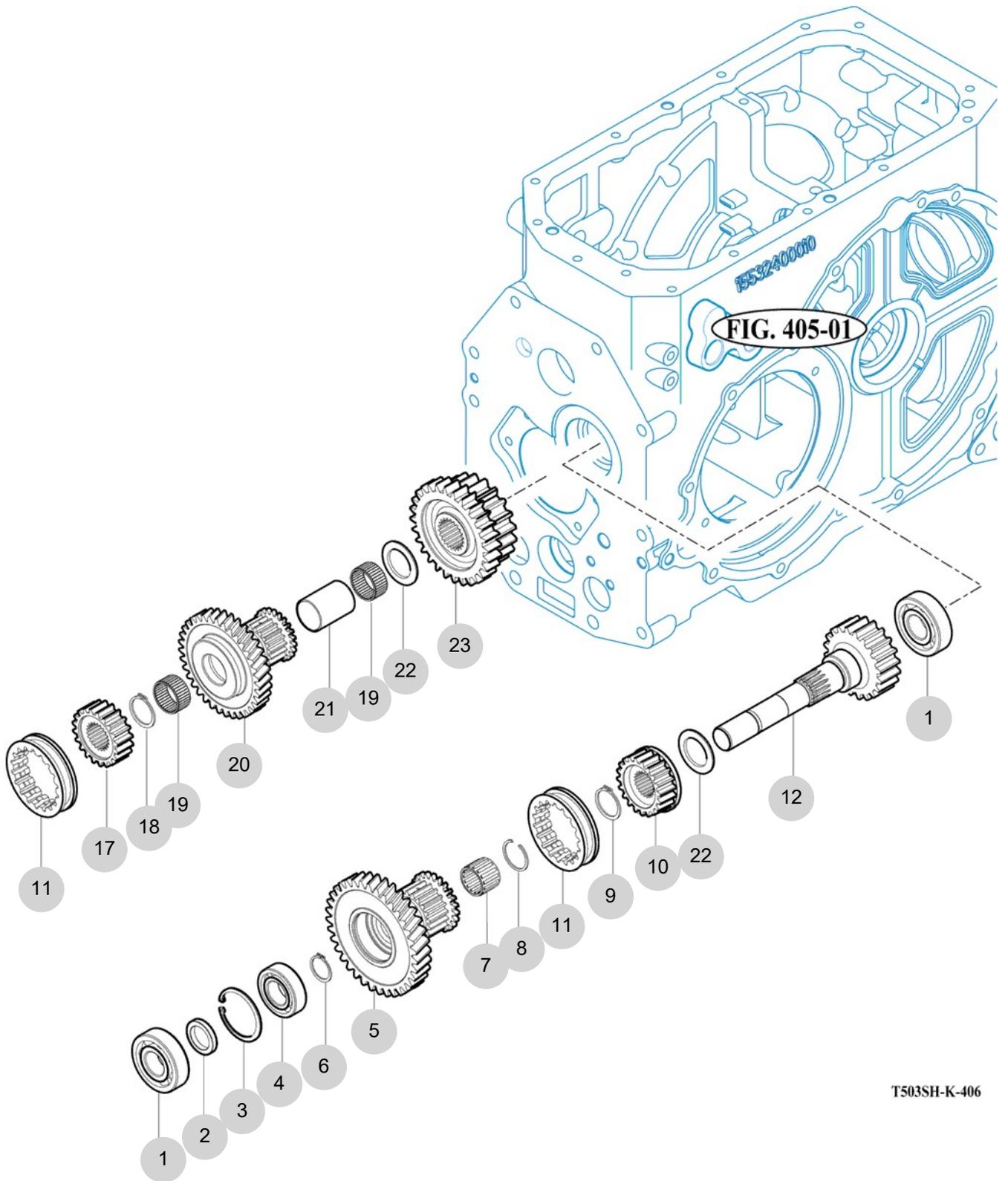

T503SH-K-406

NOTE

FIG 407

SUB CHANGE SHIFTER

년/월
Year/Month

T494NH

2022-12

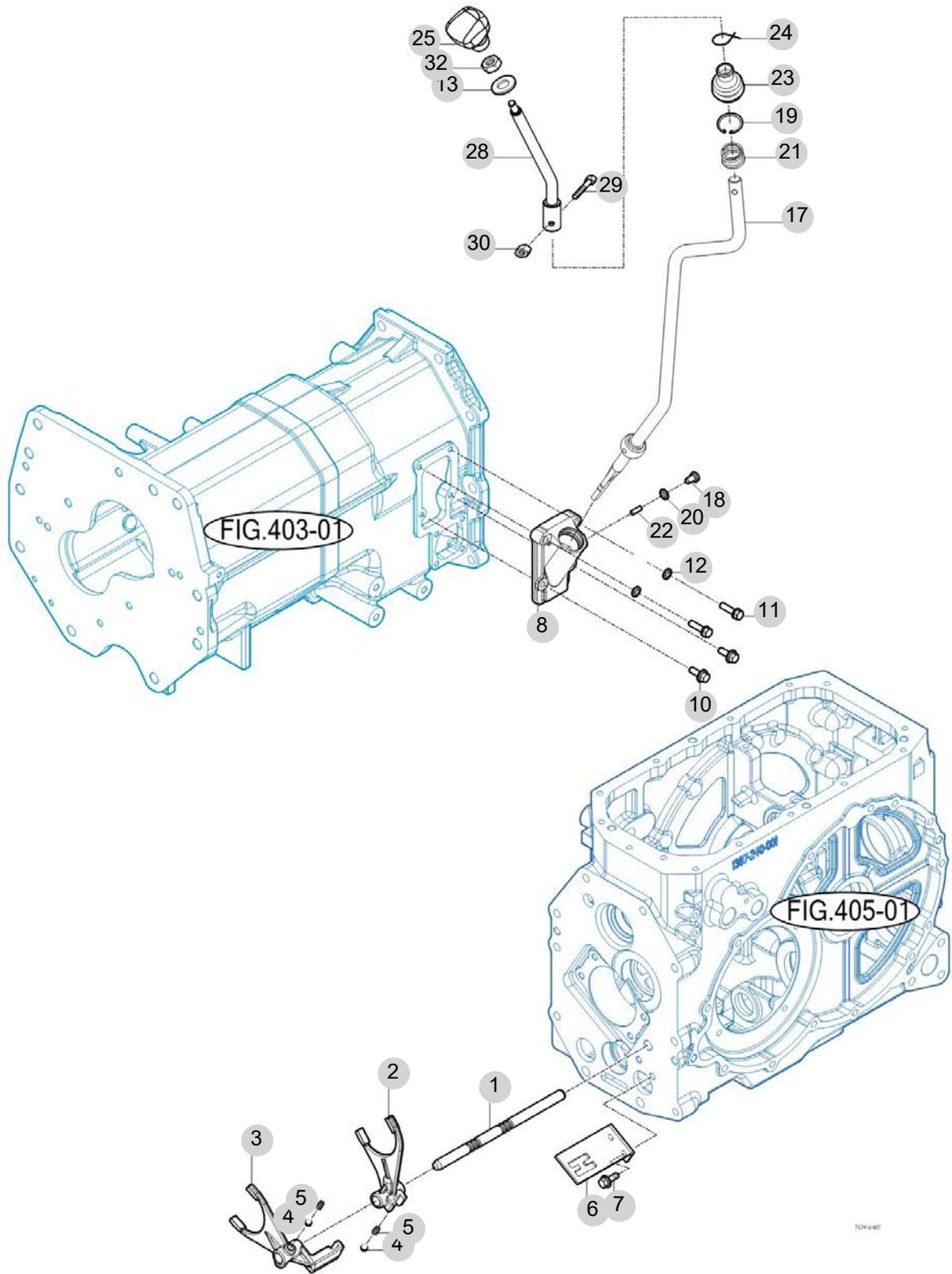

NOTE

FIG 408

DRIVE GEARS

년/월
Year/Month

T494NH

2022-12

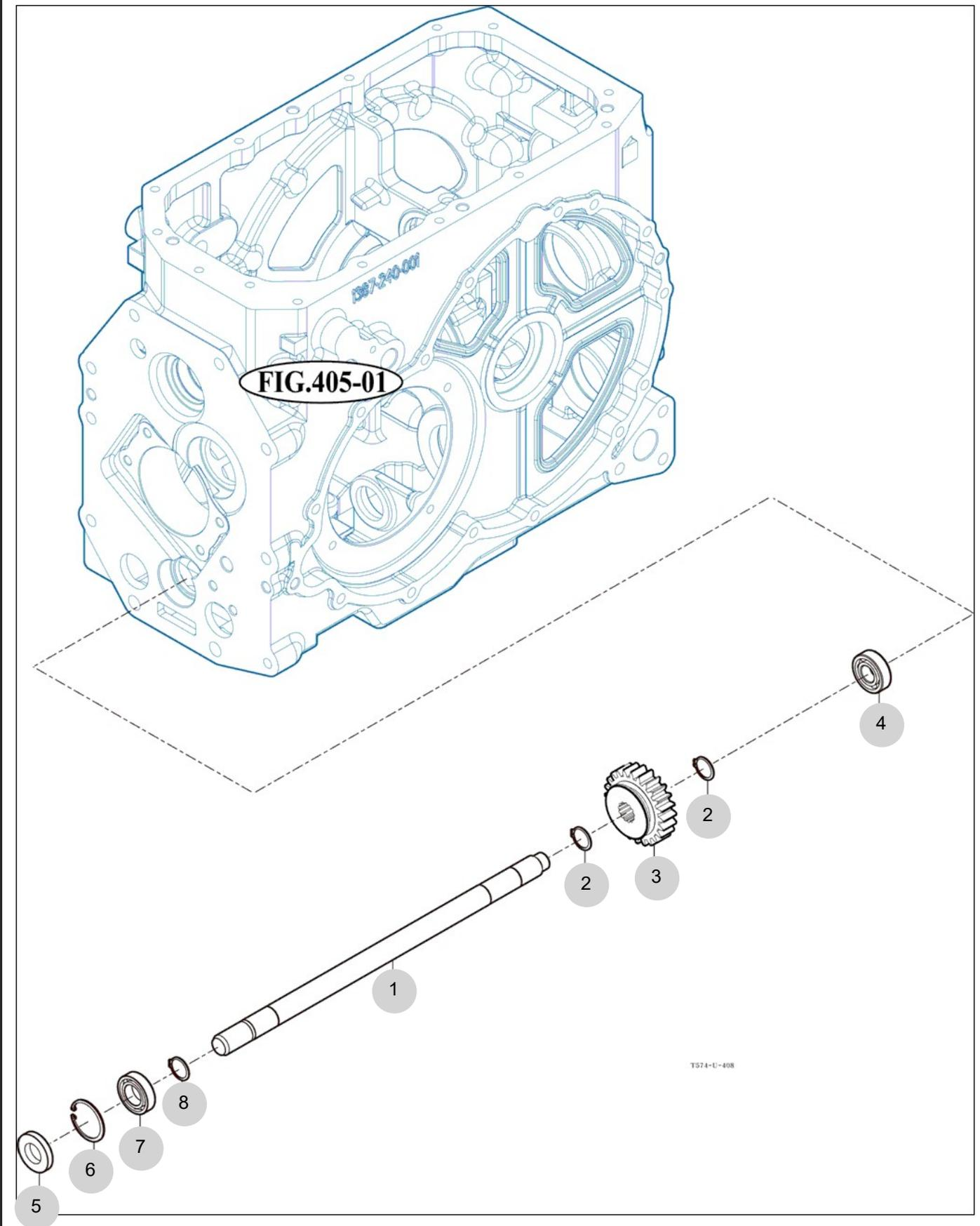

NOTE

FIG 409

T494NH

4WD CHANGE LEVER

년/월
Year/Month

2022-12

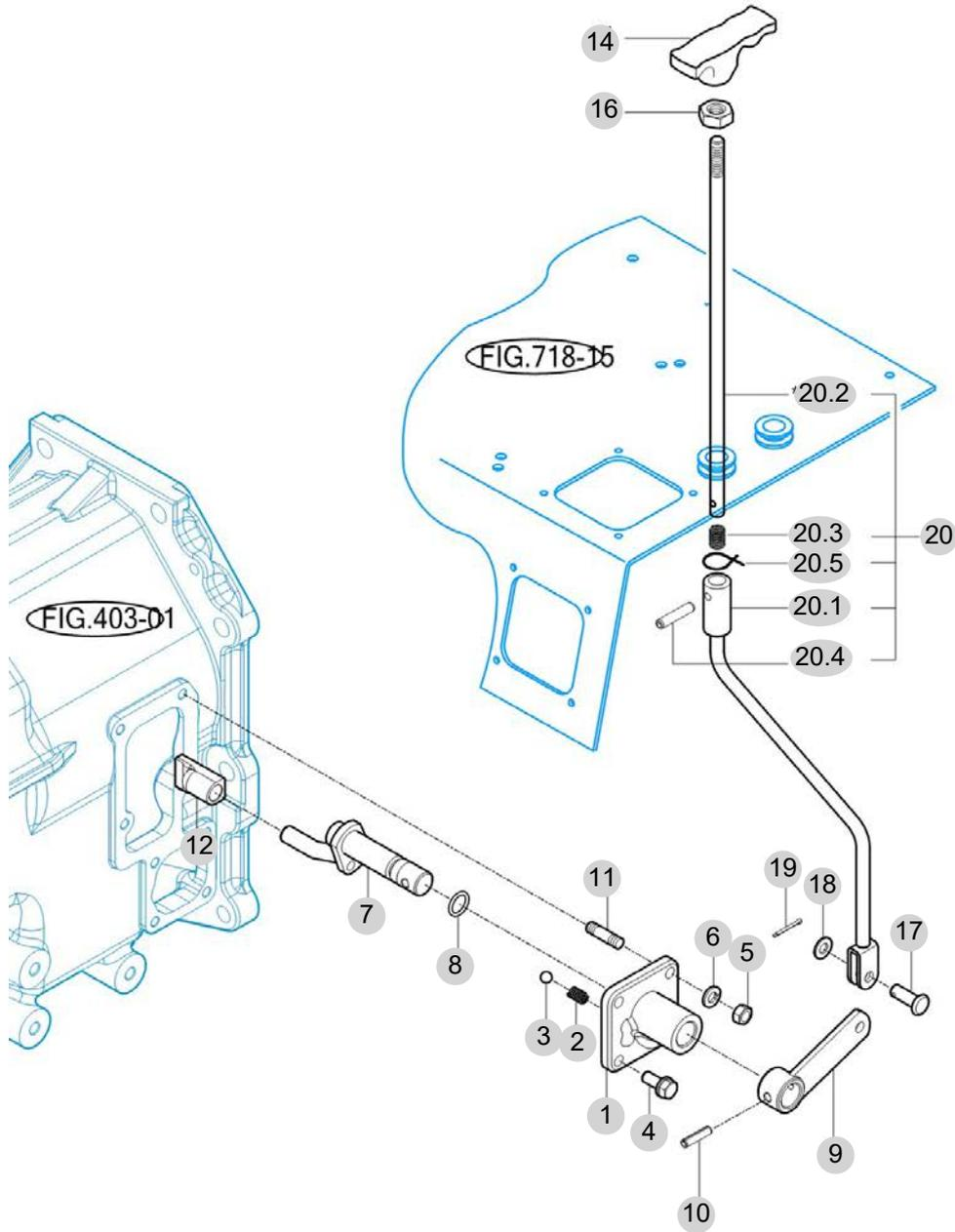

*NOT SERVICED SEPARATELY

T574-U-409

NOTE

FIG 410

T494NH

P.T.O DRIVE SHAFT

년/월
Year/Month

2022-12

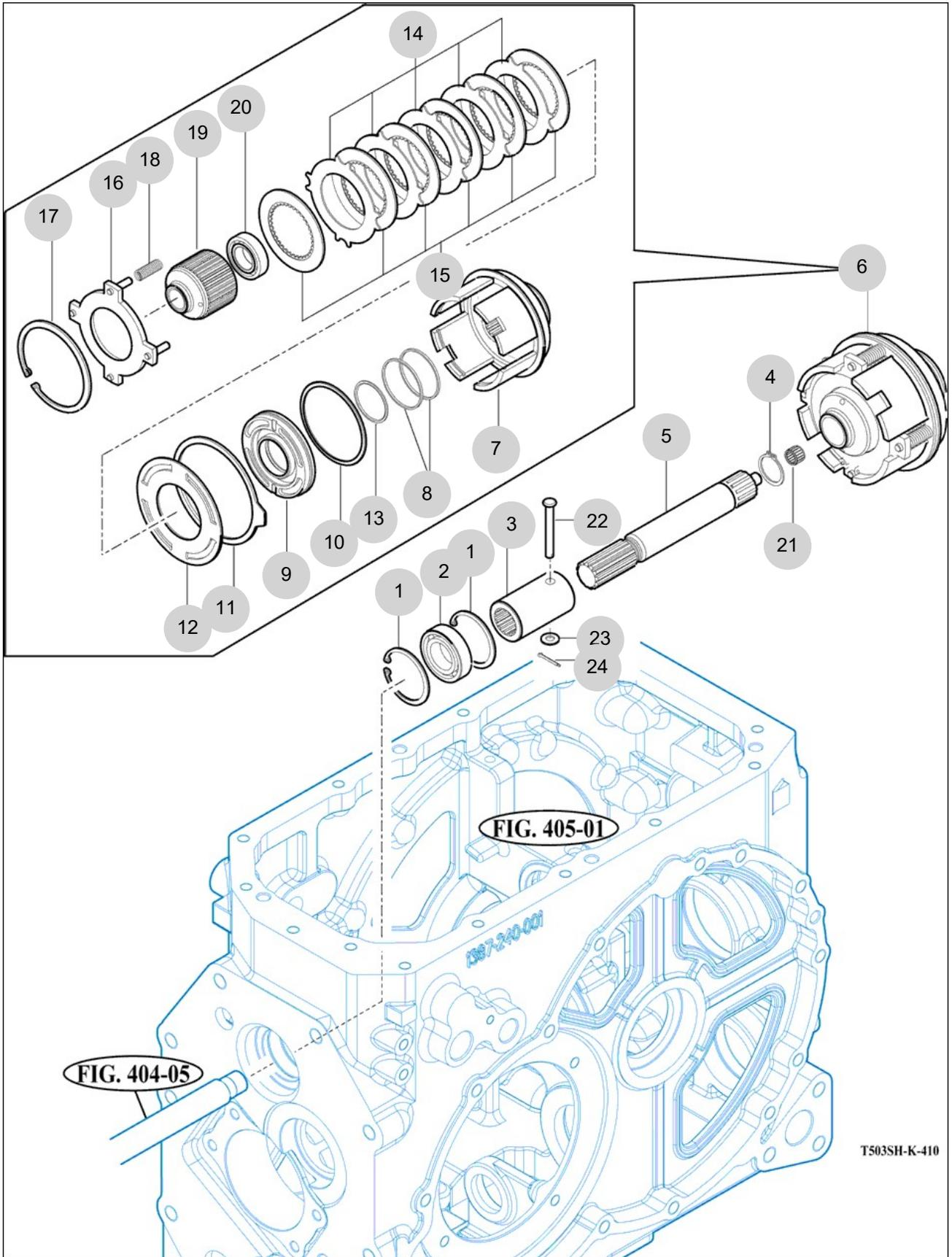

NOTE

FIG 411

P.T.O CHANGE GEARS

년/월
Year/Month

T494NH

2022-12

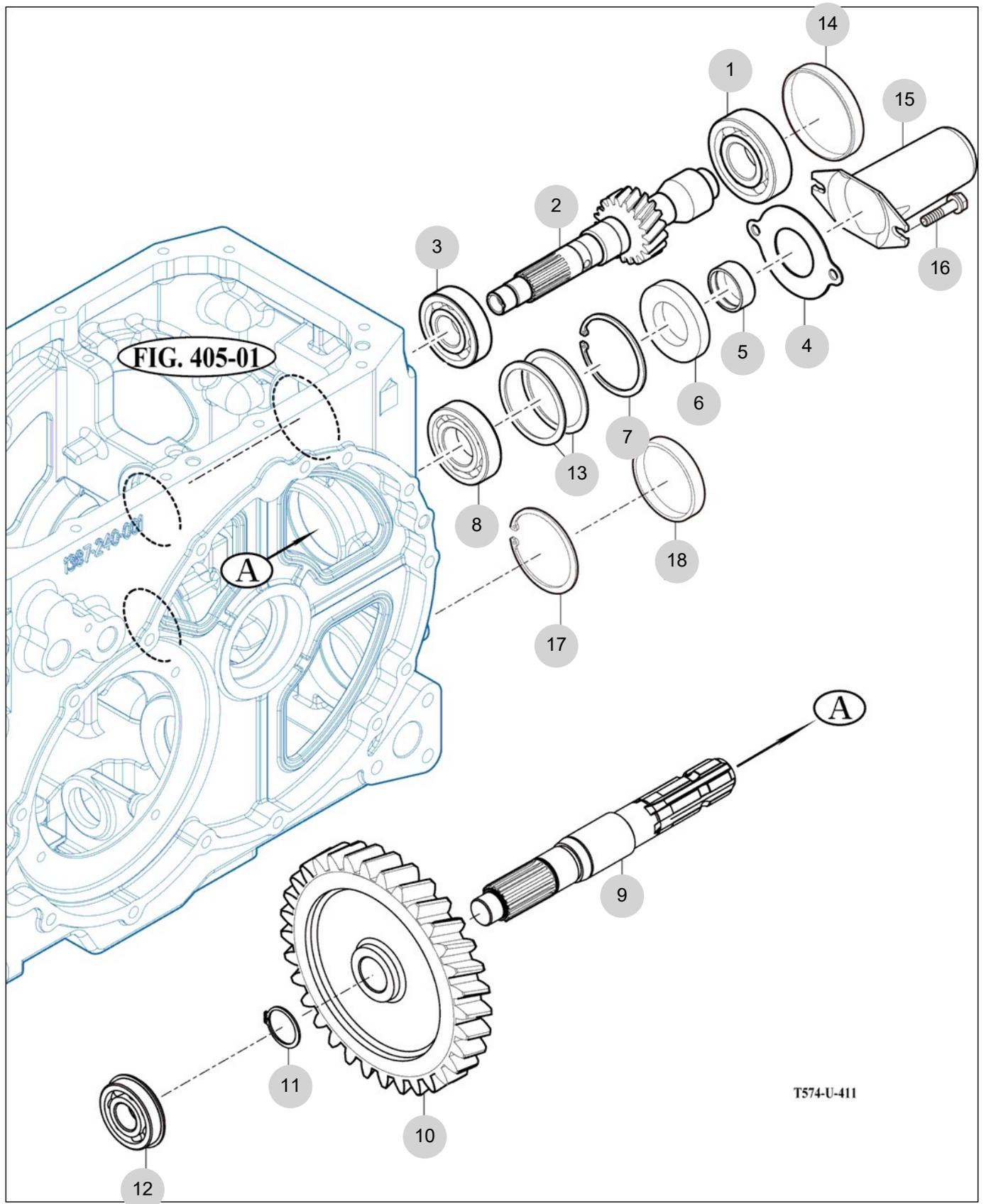

NOTE

FIG 412

REAR DIFFERENTIAL GEARS

년/월
Year/Month

2022-12

T494NH

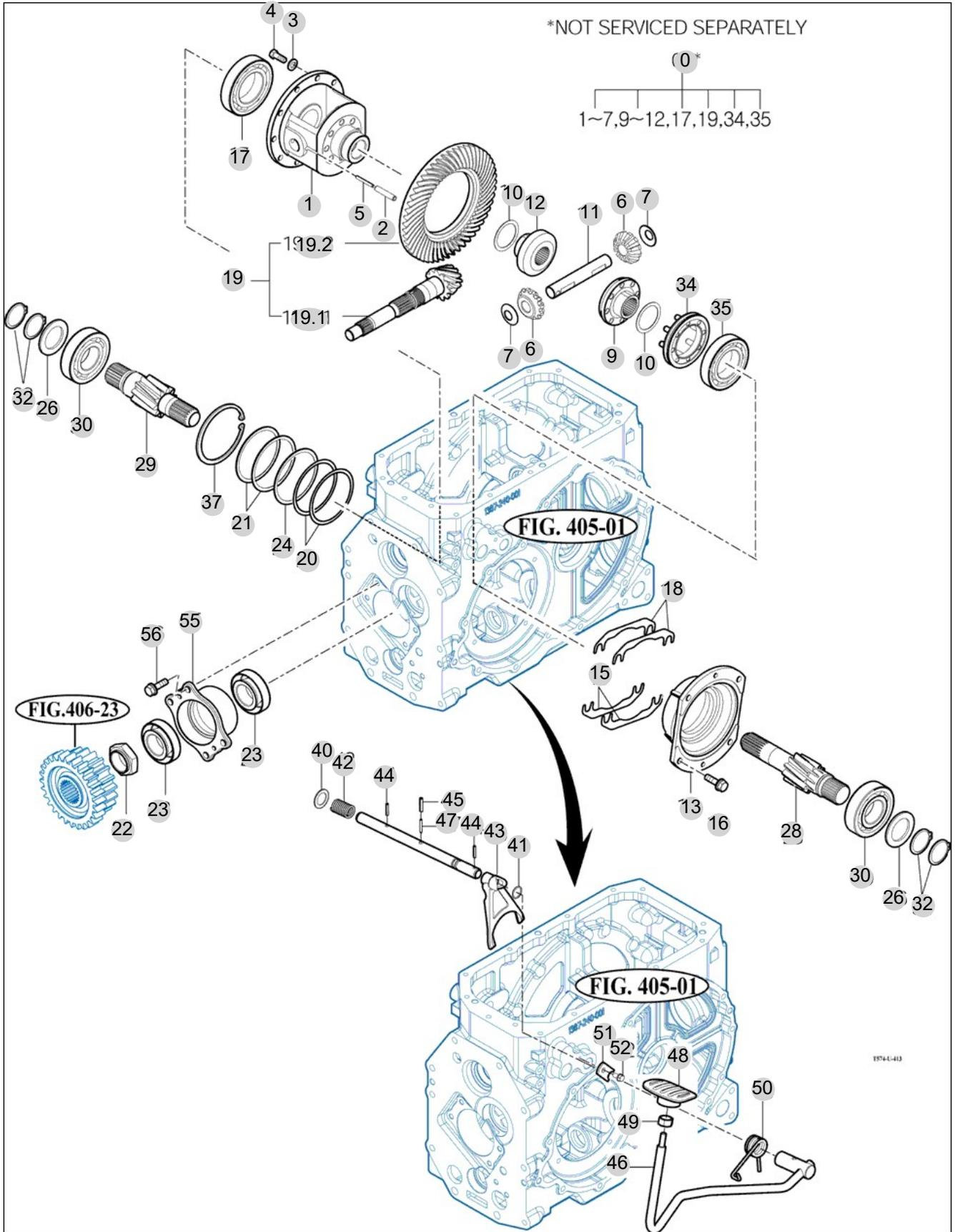

NOTE

FIG 412		REAR DIFFERENTIAL GEARS					년/월 Year/Month		
							2022-12		
T494NH		KEY NO	PART NO	DESCRIPTION	SPEC	QTY	REPAIR	EFFECTIVE DATE	REMARKS
412	0	14523031001	DIFF ASSY, RR 47PS			1			
412	1	14523030010M	CASE , DIFF			1			
412	2	V5801408040	PIN , SPRING	8X50		1			
412	3	V4011600100	WASHER , SPRING	M10		10			
412	4	V2024610025	BOLT , HEX FINE	M10X25		10			
412	5	V5801405036	PIN , SPRING	5X36		1			
412	6	14523180041	PINION , DIFF	1X1X1		2			
412	7	14523030080	COLLAR , PINION	T=1.0		2			
412	9	14523180061	PINION , BEVEL 16T LH	1X1X1		1			
412	10	14523030100	WASHER , THRUST	D=52.5		2			
412	11	14523030110	SHAFT , DIFF PINION	D=23		1			
412	12	14523180031	PINION , BEVEL 16T RH	1X1X1		1			
412	13	14523030131M	METAL , DIFF CASE LH			1			
412	15	14523010090	SHIM , B	T=0.2		4			
412	16	V2173610025	BOLT , HEX/S	M10X25		4			
412	17	V6001106212	BEARING , BALL	6212		1			
412	18	14523010080	SHIM , A	T=0.1		2			
412	19	14523022100	GEAR SET , 10-41T			1			
412	19.1	14523022111	PINION , BEVEL			1			
412	19.2	14523022120	GEAR , SPIRAL BEVEL			1			
412	20	14523010050	SHIM , 0.1	T=0.1		1			
412	22	15533030020	NUT , M40 P1,5	육각B=55		1			
412	23	V6321132208	BEARING , TAPER-ROLLER	32208CR		2			
412	24	14523010100	SHIM , 0.2	T=0.2		2			
412	26	15133060030	COLLAR , THRUST 45X68X4			2			
412	28	14523060010	PINION , LH HERICAL11T			1			
412	29	14523060020	PINION , RH HERICAL11T			1			
412	30	V6001106309	BEARING , BALL	6309		2			
412	32	V7041400450	C-RING , SHAFT	45		4			
412	34	14523033400	SLEEVE COMP			1			
412	35	V6001106211	BEARING , BALL	6211		1			
412	37	V7051401100	C-RING , HOLE	110		1			
412	39	15533193010	SHAFT , DIFF LOCK	D=20		1			
412	40	V4111600200	WASHER , PLAIN	M20		1			
412	41	V7201024016	O-RING , P	P16		1			
412	42	17973030420	SPRING	(D=3.6) X22.5X74.5		1			
412	43	14523190011M	FORK , DIFF LOCK			1			
412	44	V5801406032	PIN , SPRING	6X32		2			
412	45	V5801408036	PIN , SPRING	8X36		1			
412	46	15533193100	PEDAL COMP , DIFF LOCK			1			
412	47	V5801405036	PIN , SPRING	5X36		1			
412	48	14521220120	PEDAL COMP,ACCEL	1X1X1		1			
412	49	V3342600100	NUT , HEX FINE/2	M10		1			
412	50	15533190020	SPRING , DIFF PEDAL			1			
412	50	15533190021	SPRING , DIFF PEDAL	D=5.5		1			
NOTE									

FIG 413

REAR AXLE HOUSING

년/월
Year/Month

T494NH

2022-12

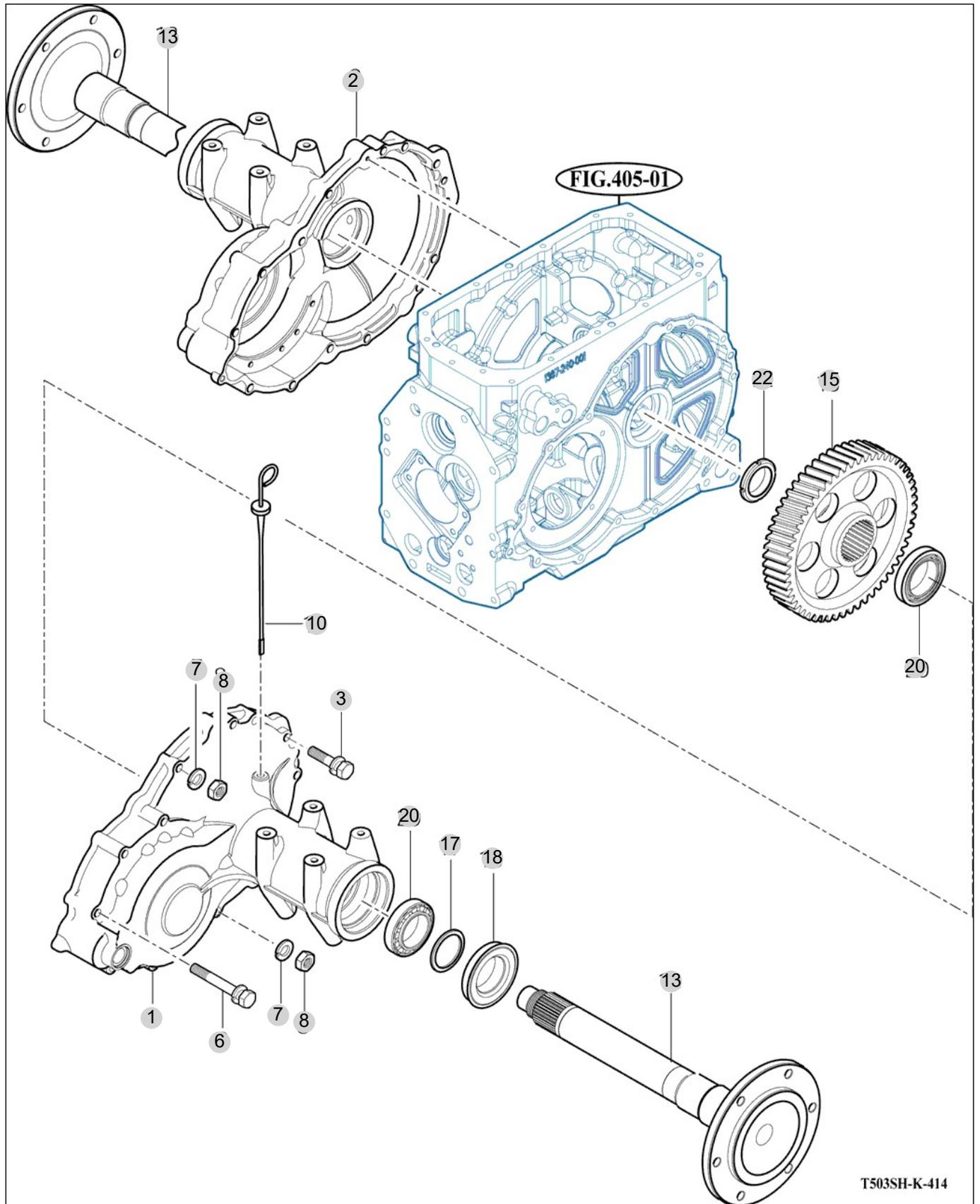

T503SH-K-414

NOTE

5. Front Axle PART NO. T5

FIG 501 FRONT AXLE SUPPORT	169
FIG 502 FRONT DRIVE SHAFT	171
FIG 503 FRONT AXLE HOUSING	173
FIG 504 FRONT DIFFERENTIAL GEARS	175
FIG 505 FRONT GEAR CASE (1)	177
FIG 506 FRONT GEAR CASE (2)	179
FIG 507 FRONT GEAR CASE (3)	181

FIG 501

T494NH

FRONT AXLE SUPPORT

년/월
Year/Month

2022-12

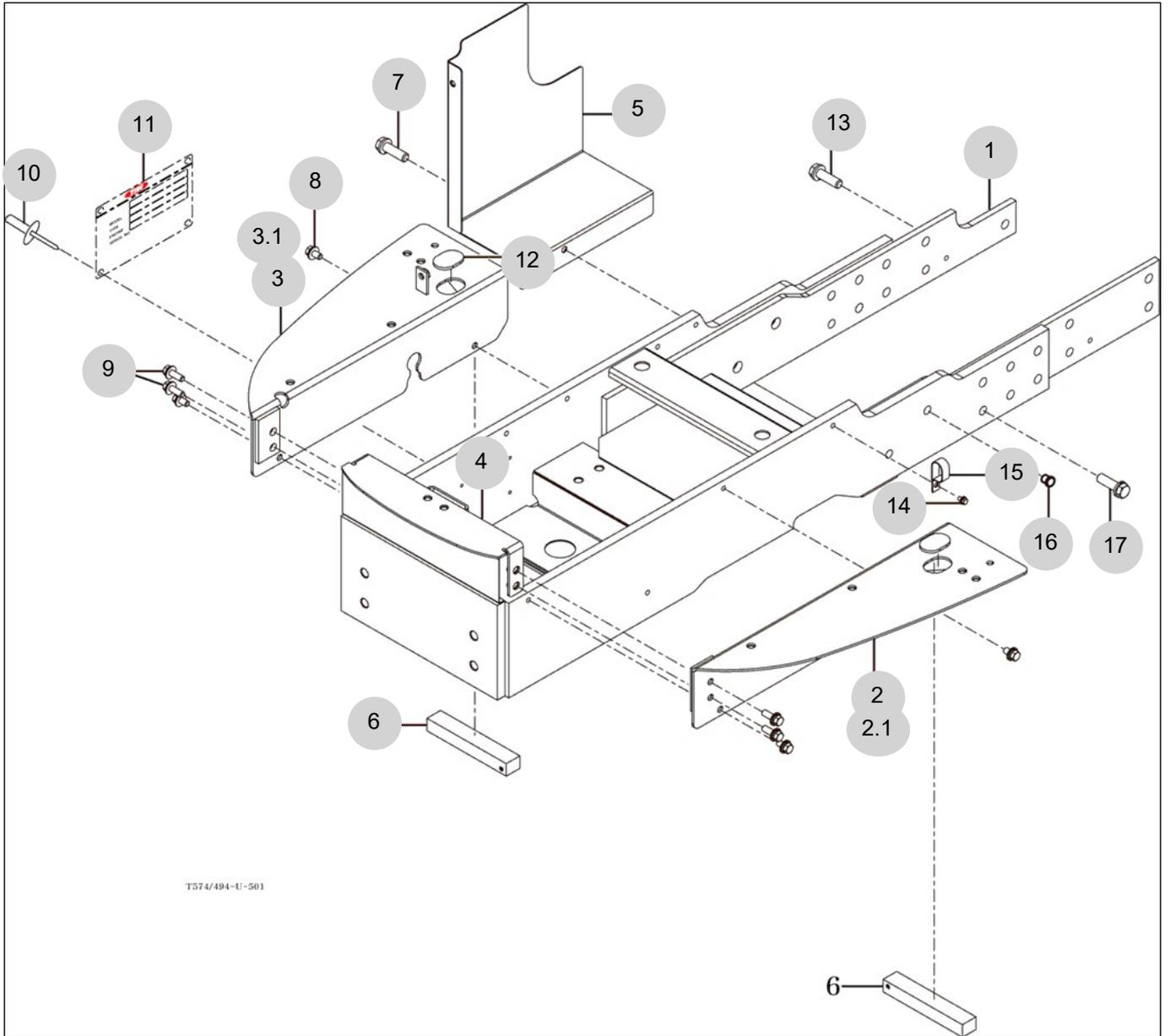

NOTE

FIG 503

FRONT AXLE HOUSING

년/월
Year/Month

T494NH

2022-12

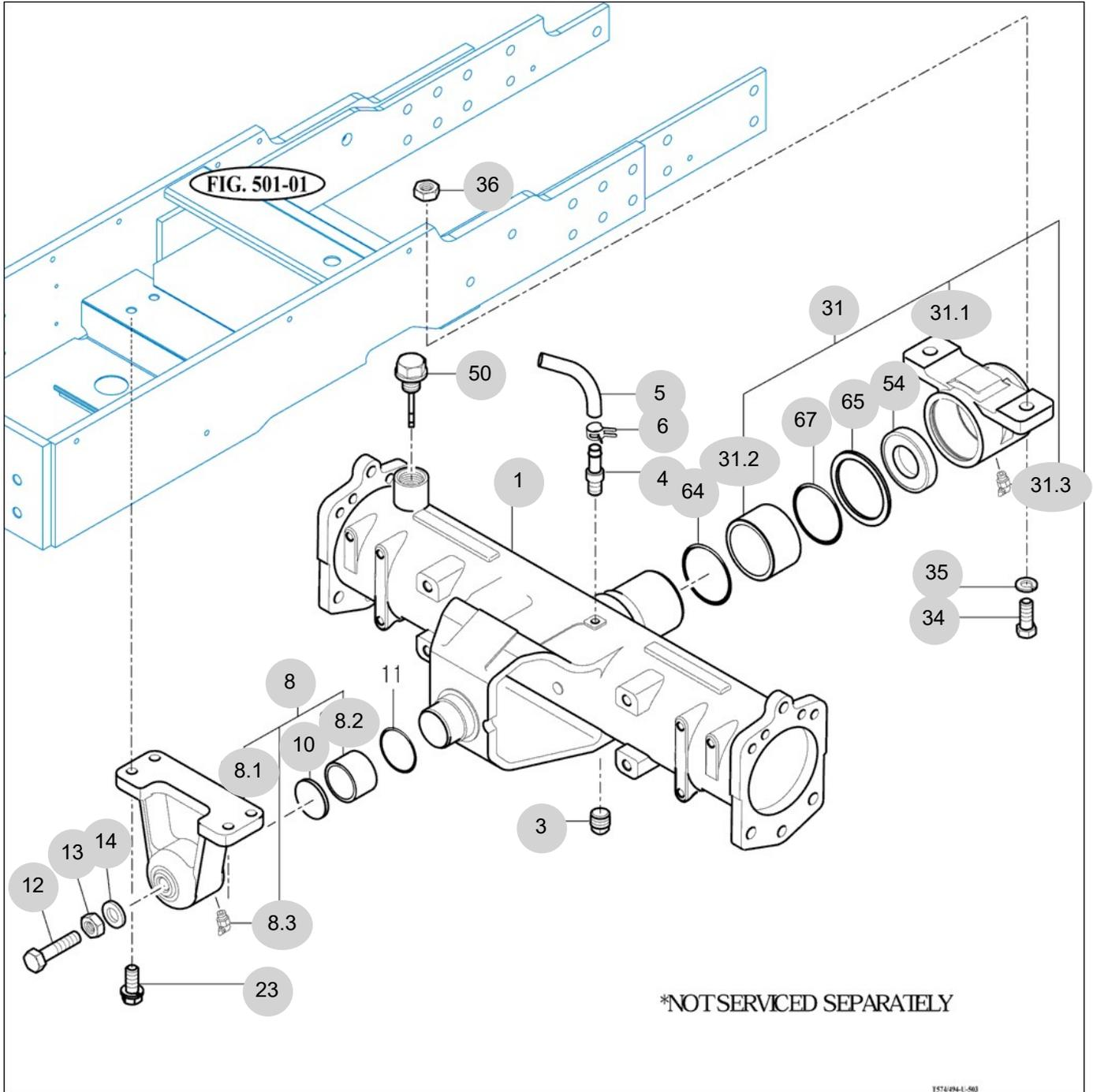

NOTE

FIG 504

FRONT DIFFERENTIAL GEARS

년/월
Year/Month

2022-12

T494NH

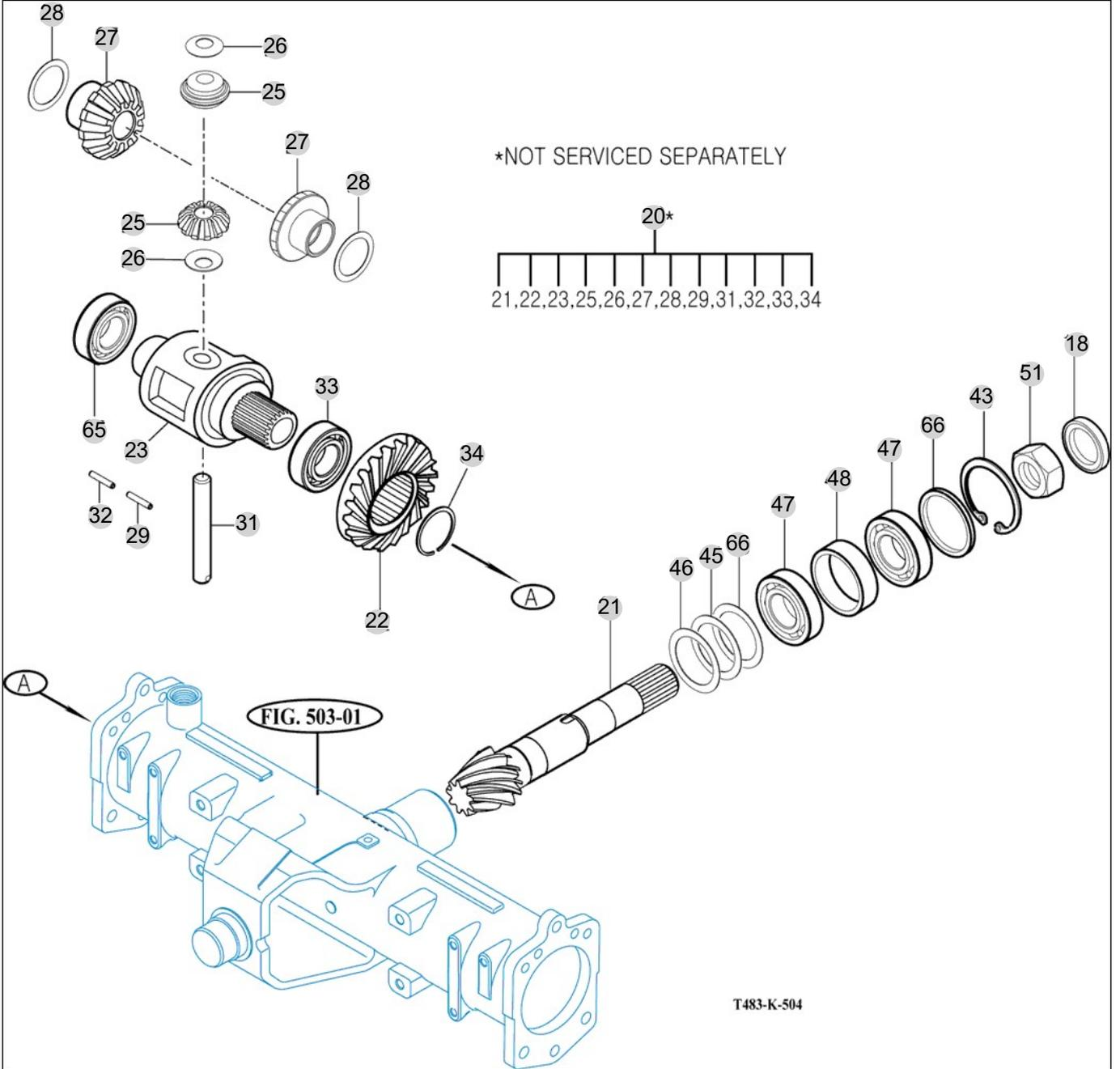

NOTE

FIG 505

T494NH

FRONT GEAR CASE (1)

년/월
Year/Month

2022-12

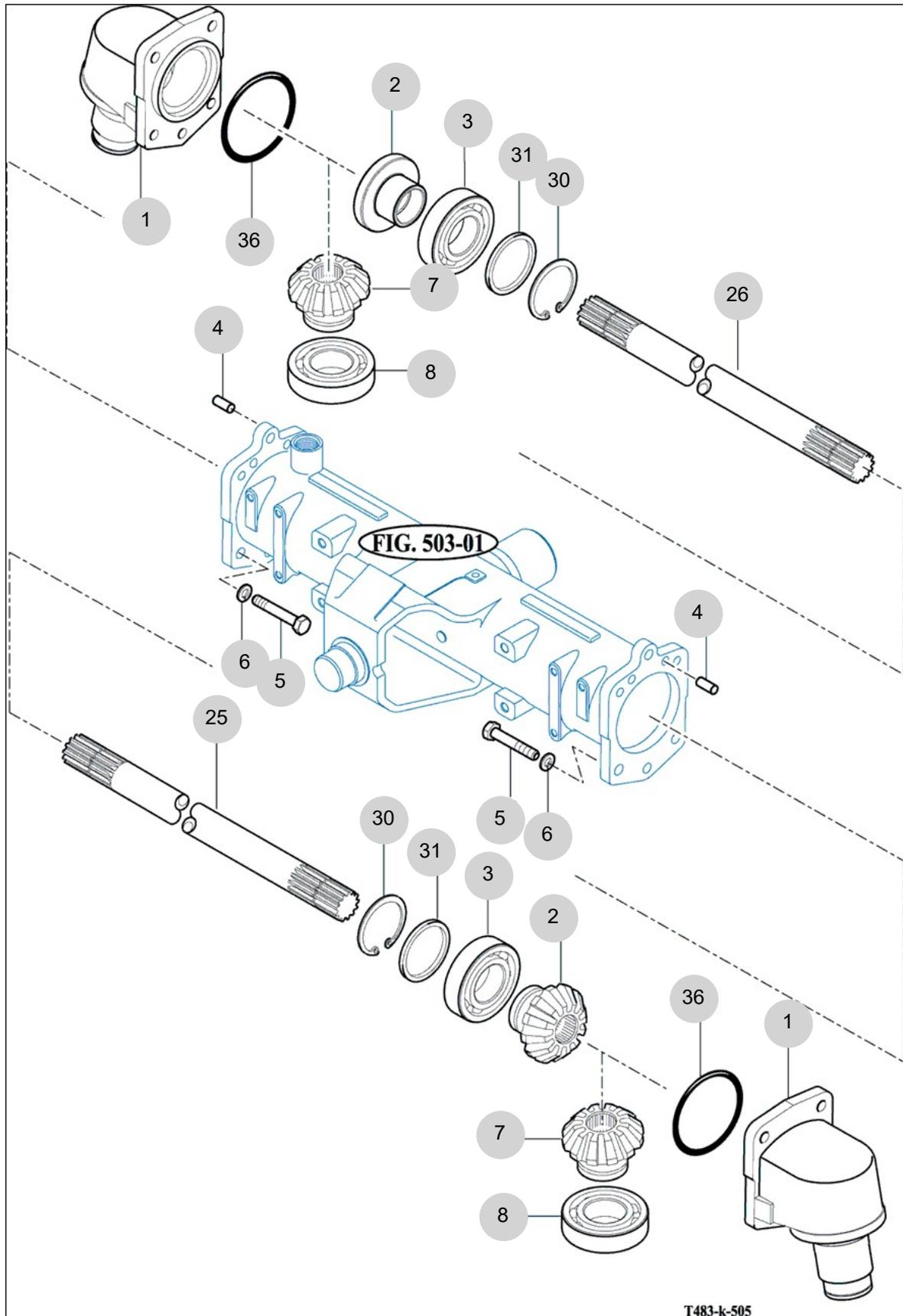

T483-k-505

NOTE

FIG 506

FRONT GEAR CASE (2)

년/월
Year/Month

2022-12

T494NH

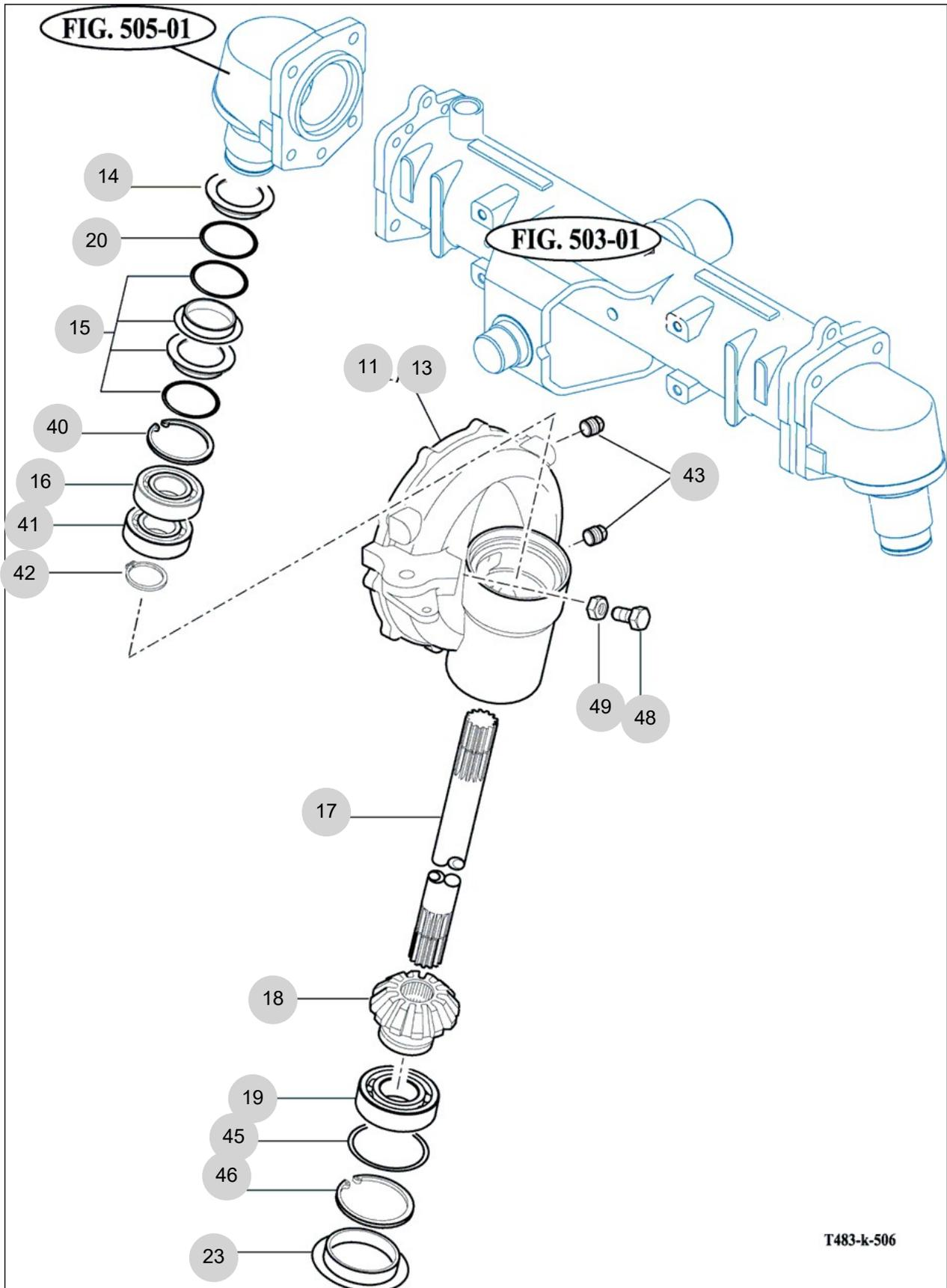

T483-k-506

NOTE

FIG 507

FRONT GEAR CASE (3)

년/월
Year/Month

2022-12

T494NH

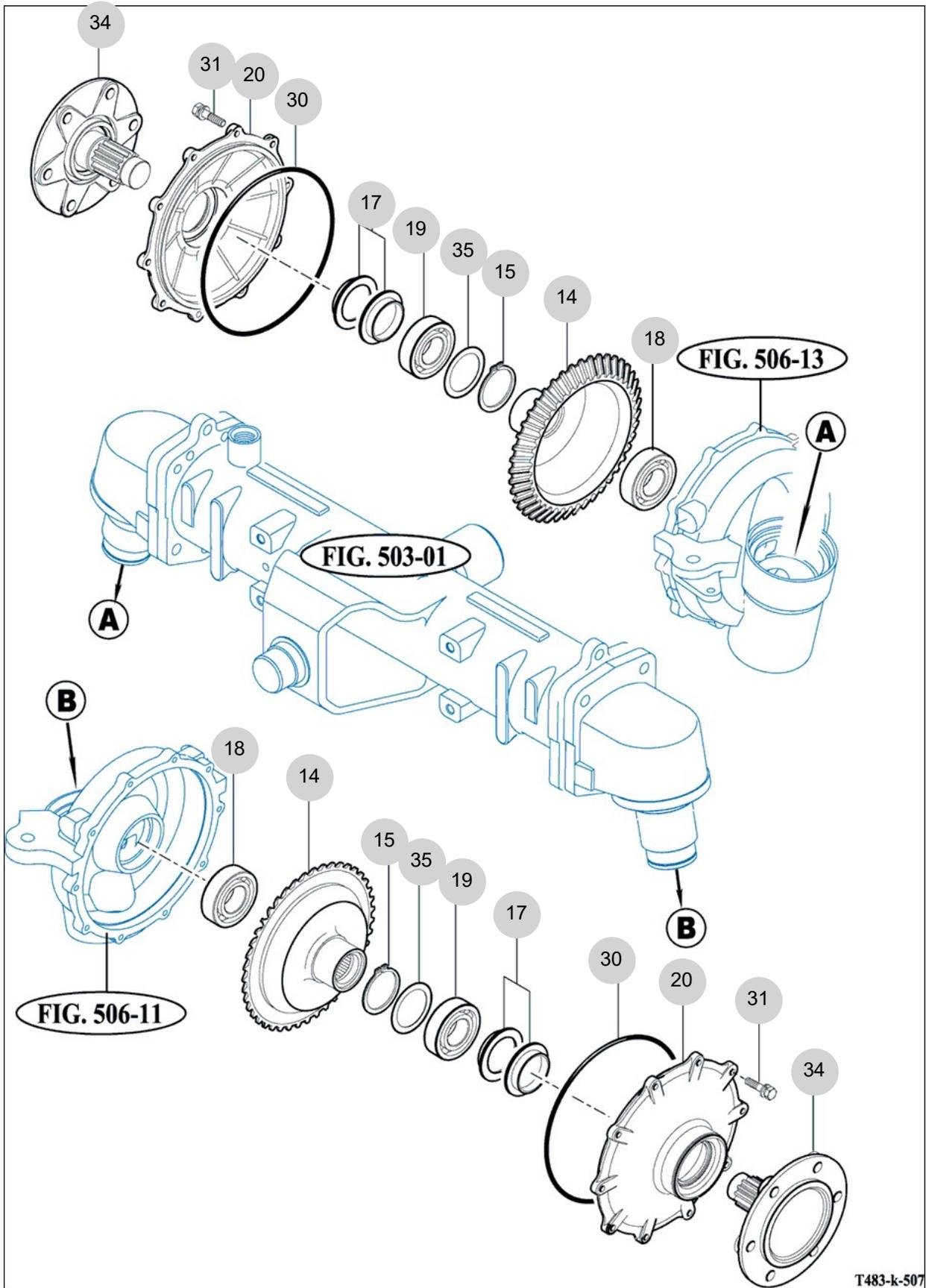

NOTE

6. Hydraulic/3P-Link PART NO. T6

FIG 601 CYLINDER CASE	184
FIG 602 LIFT ARM	186
FIG 603 CYLINDER	188
FIG 604 POSITION LINK	190
FIG 605 CONTROL VALVE	192
FIG 606 DRAFT LINK	194
FIG 607 POSITION & DRAFT LEVER	196
FIG 607-2 POSITION & DRAFT LEVER(2)	198
FIG 608 EXTERIOR HYD. VALVE	200
FIG 609 HYDRAULIC PIPE	202
FIG 610 JOYSTICK	204
FIG 612 HITCH & 3-POINT LINK	207
FIG 613 LOWER LINK & LIFT ROD	210

FIG 601

CYLINDER CASE

년/월
Year/Month

2022-12

T494NH

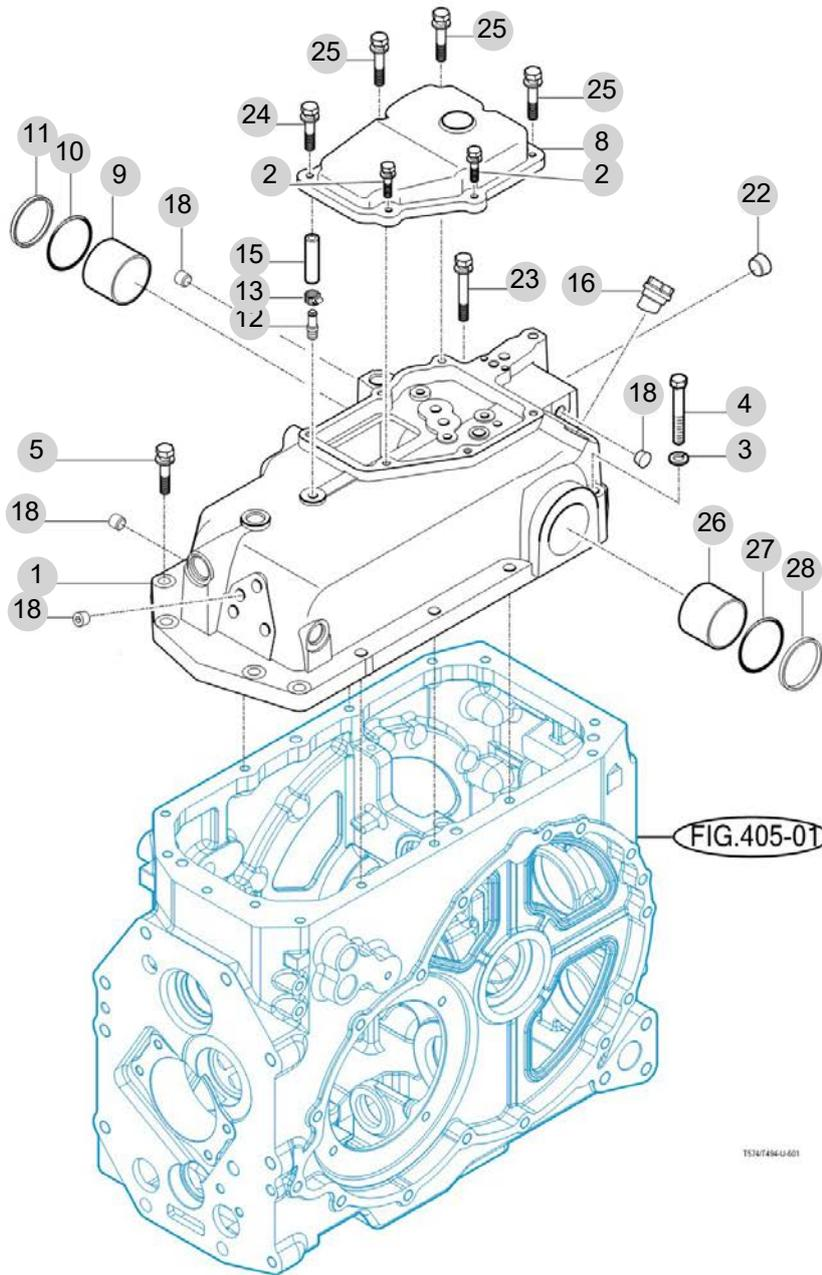

NOTE

FIG 602

T494NH

LIFT ARM

년/월
Year/Month

2022-12

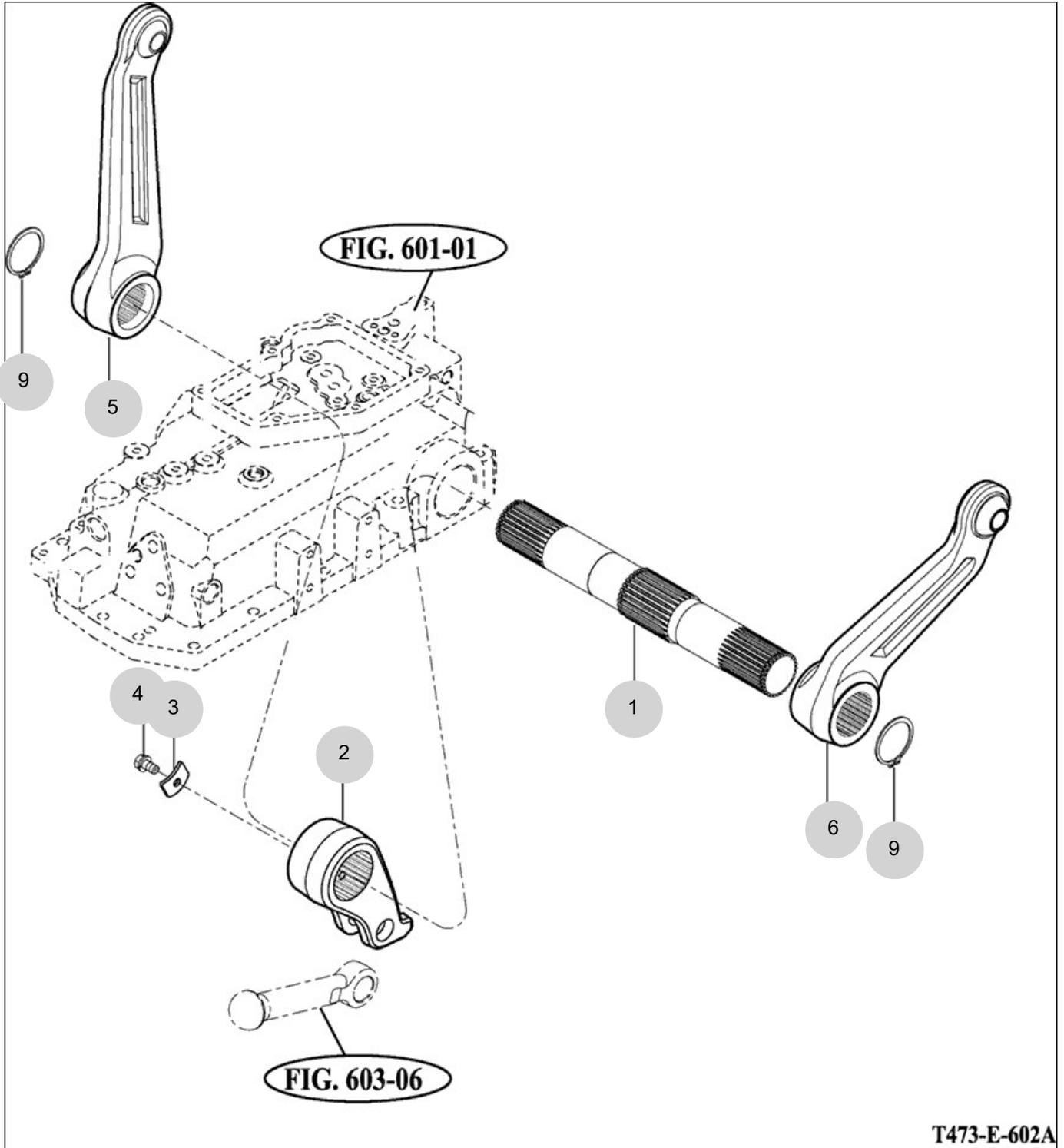

NOTE

FIG 604

POSITION LINK

년/월
Year/Month

T494NH

2022-12

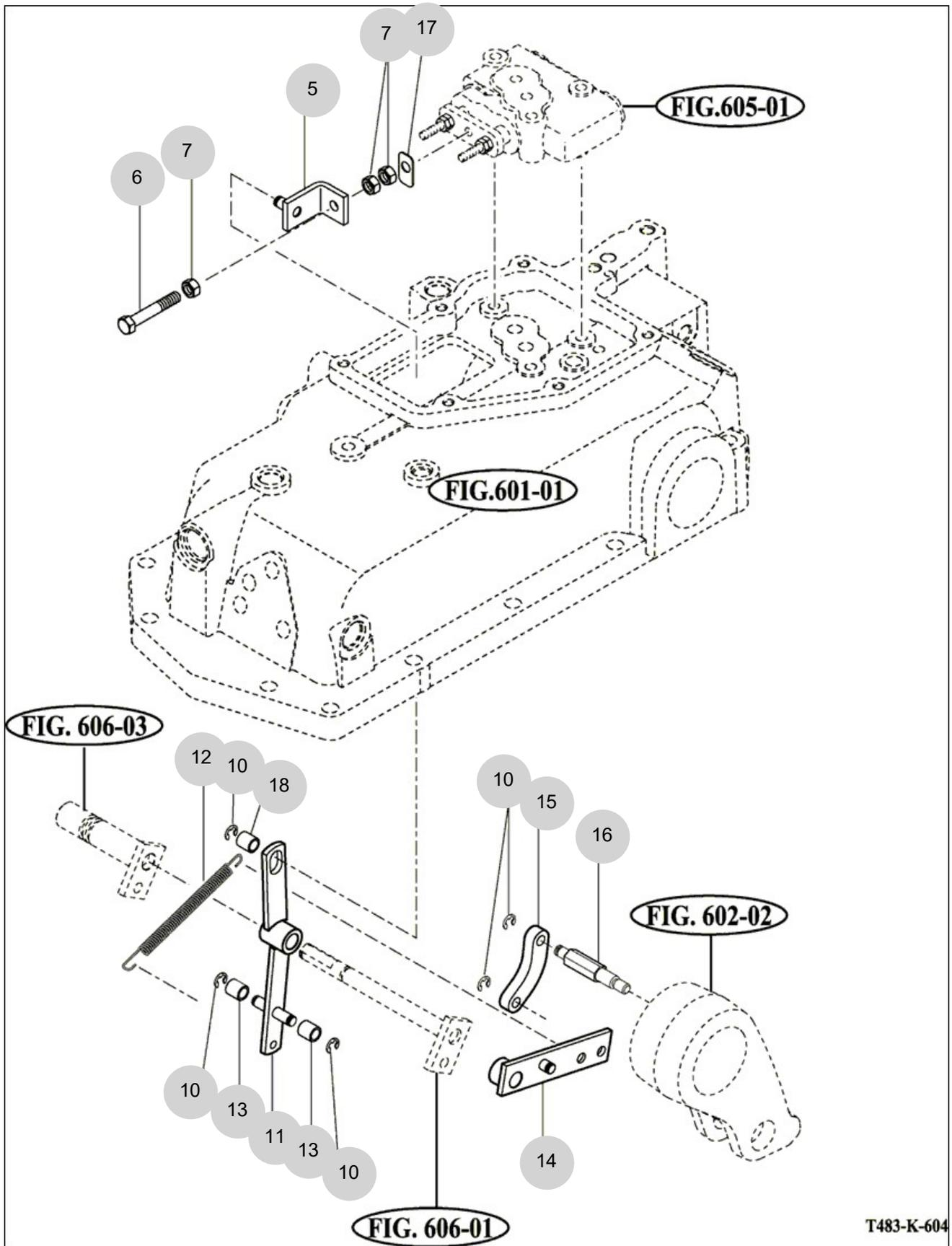

T483-K-604

NOTE

FIG 605

T494NH

CONTROL VALVE

년/월
Year/Month

2022-12

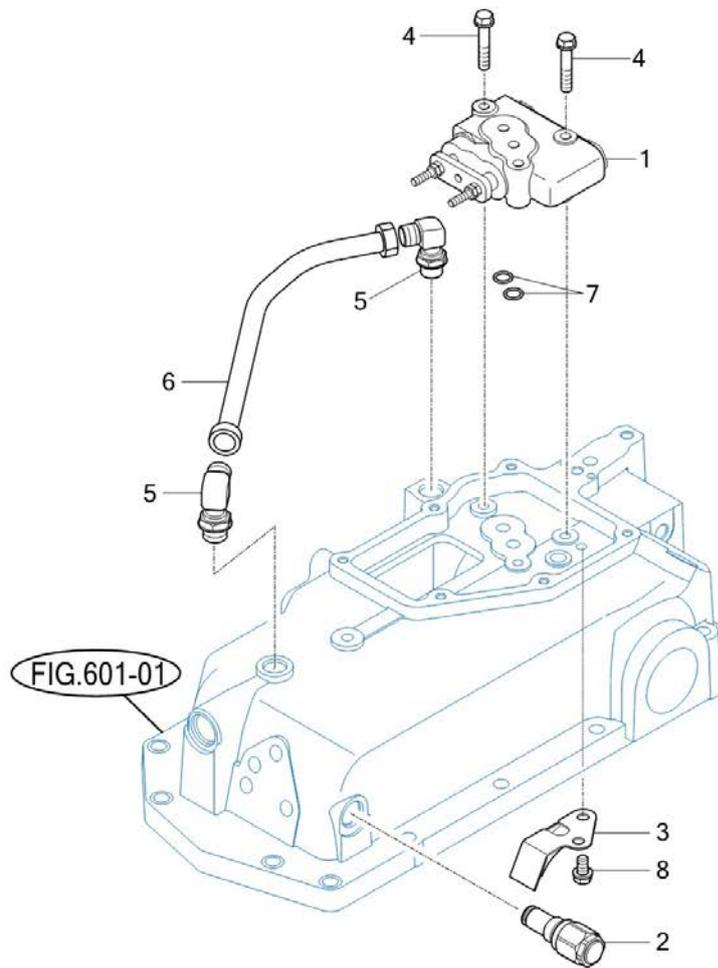

T374-U-605

NOTE

FIG 606

T494NH

DRAFT LINK

년/월
Year/Month

2022-12

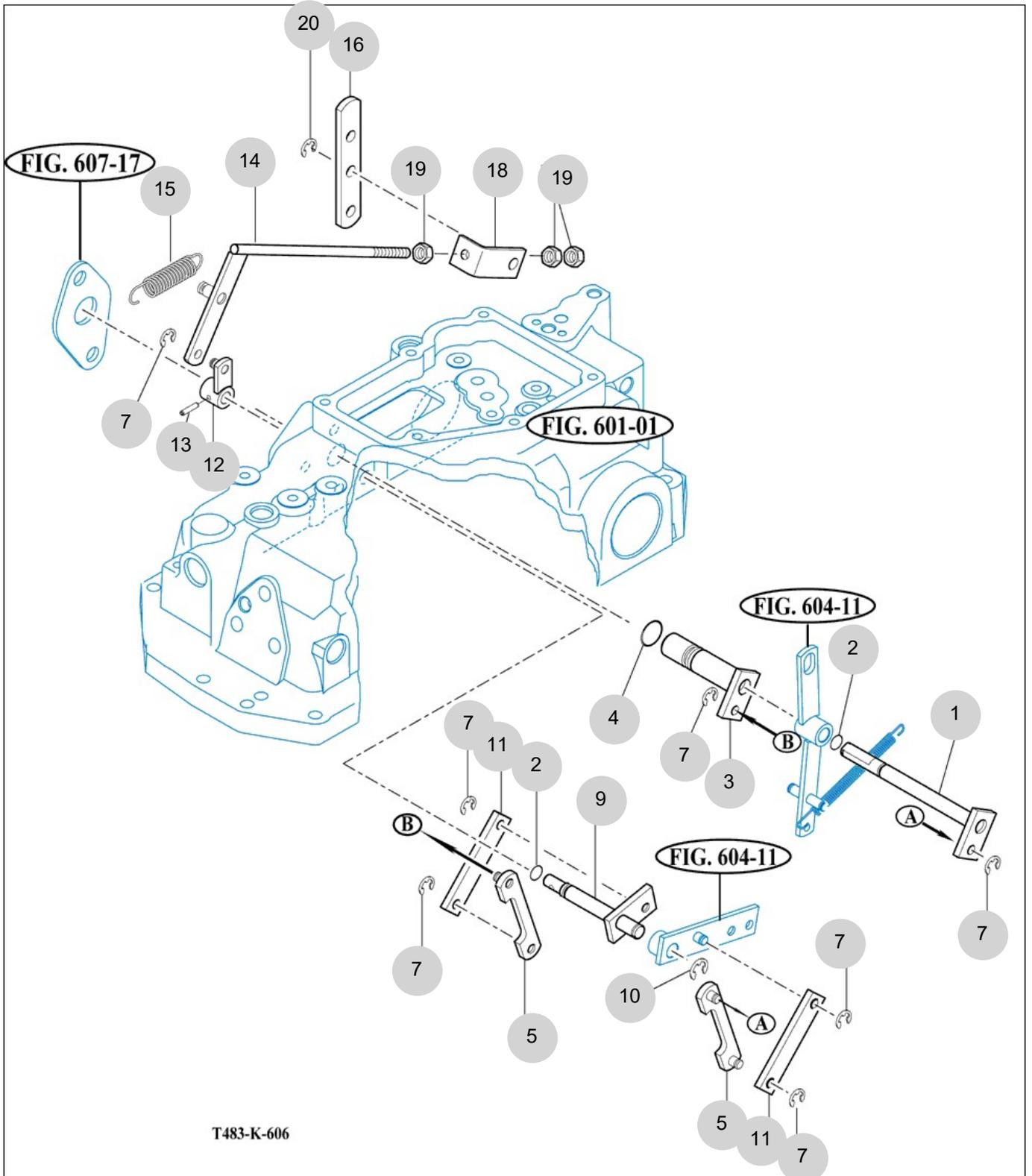

NOTE

FIG 607-2

POSITION & DRAFT LEVER(2)

년/월
Year/Month

2022-12

T494NH

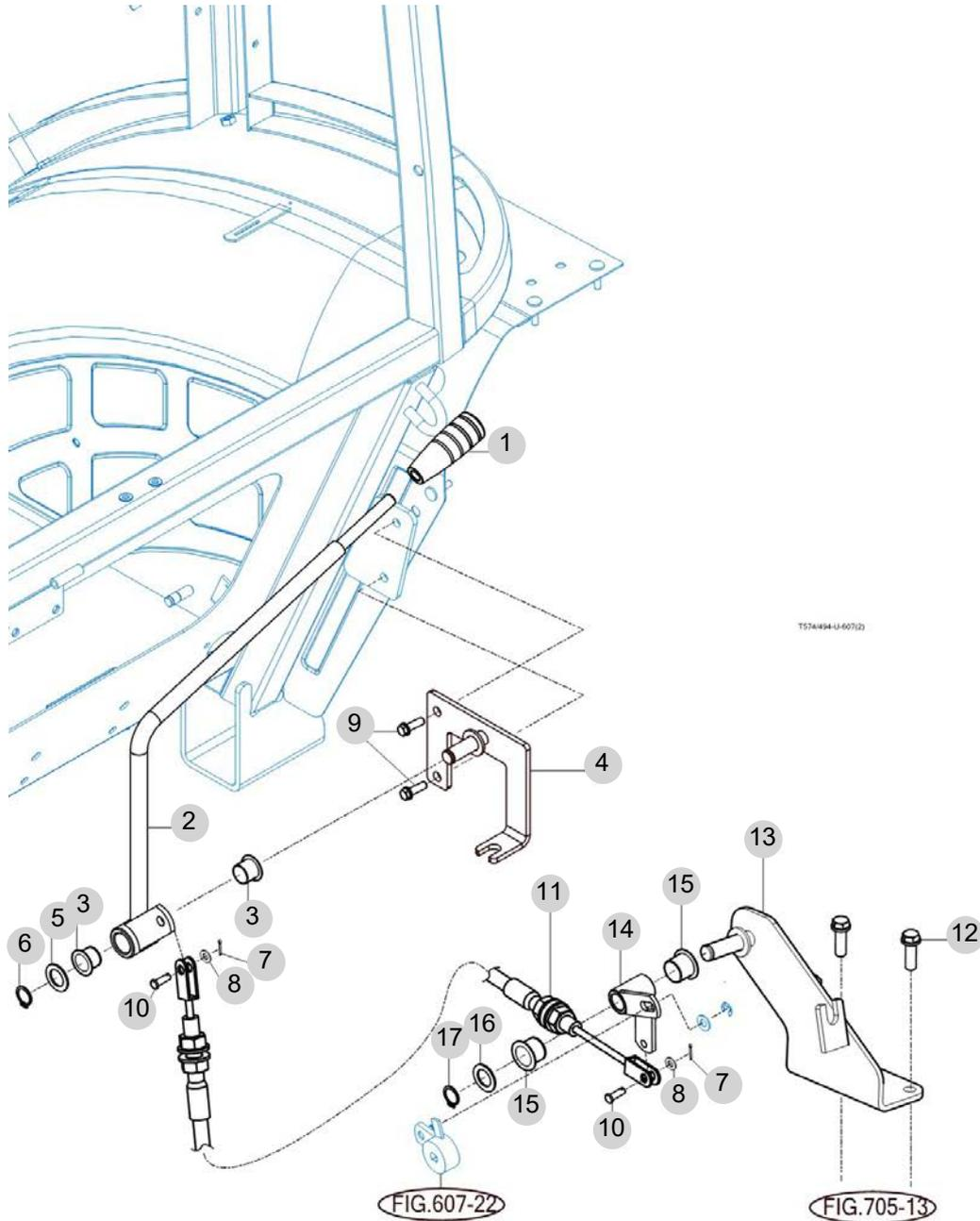

NOTE

FIG 608

EXTERIOR HYD. VALVE

년/월
Year/Month

2022-12

T494NH

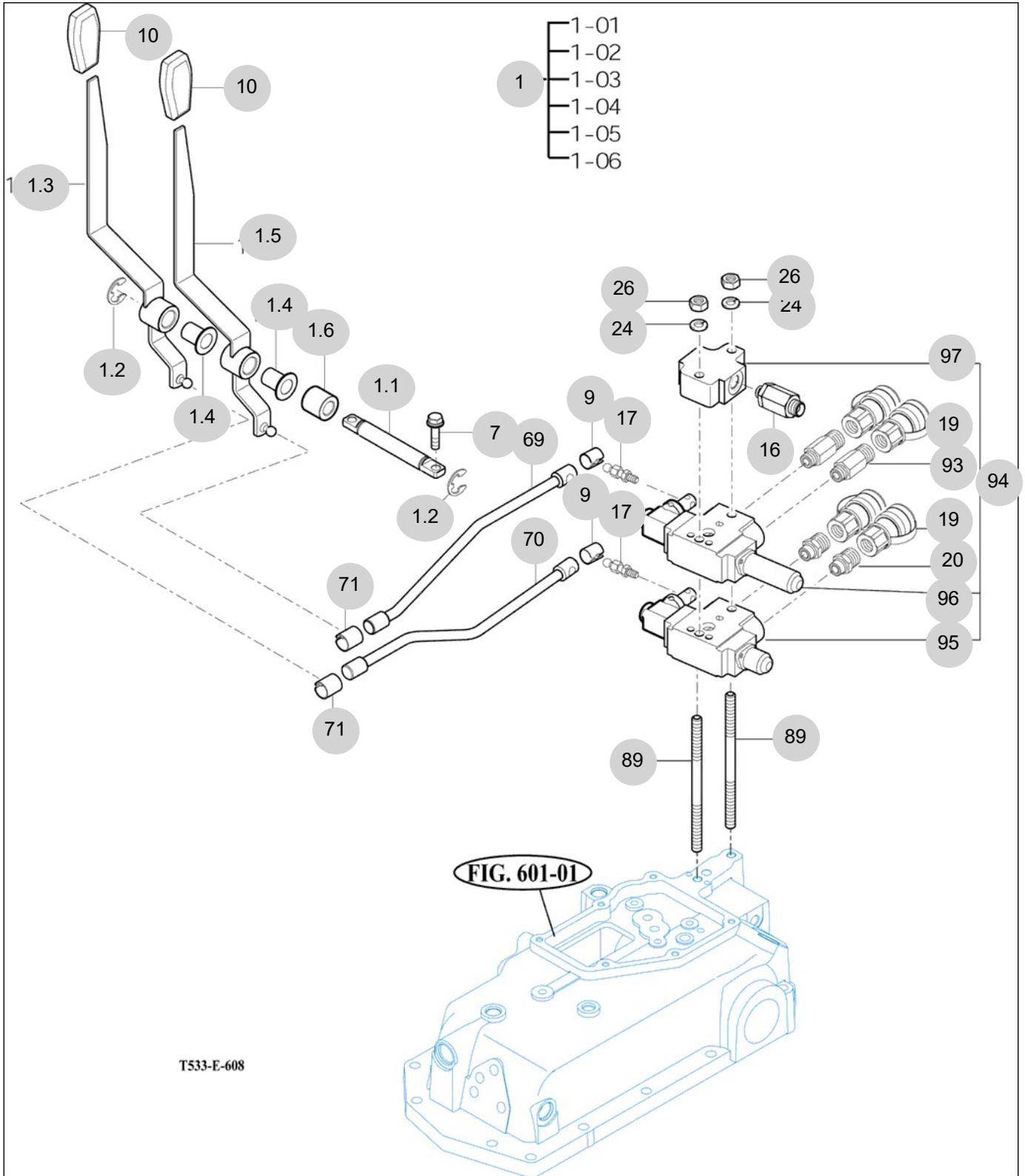

NOTE

FIG 609

HYDRAULIC PIPE

년/월
Year/Month

2022-12

T494NH

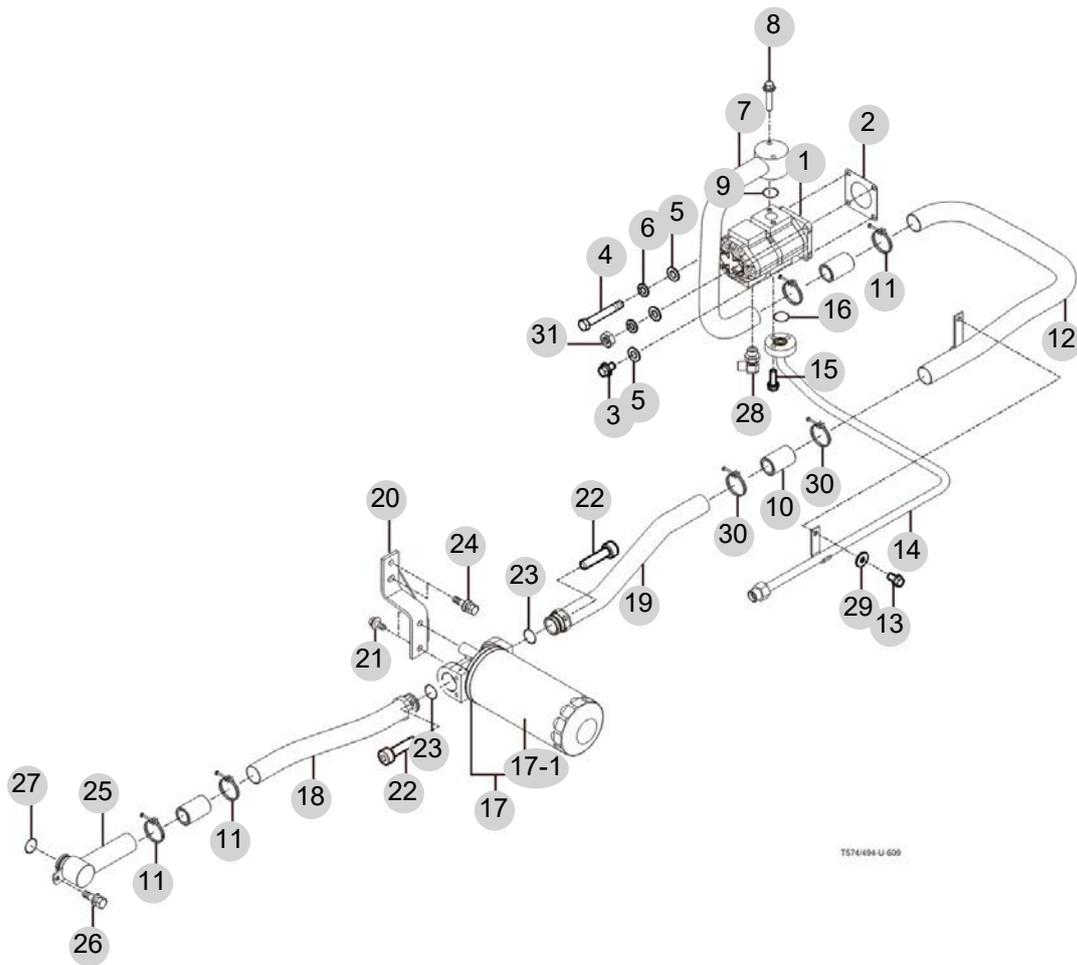

T574694 U 609

NOTE

FIG 610

T494NH

JOYSTICK

년/월
Year/Month

2022-12

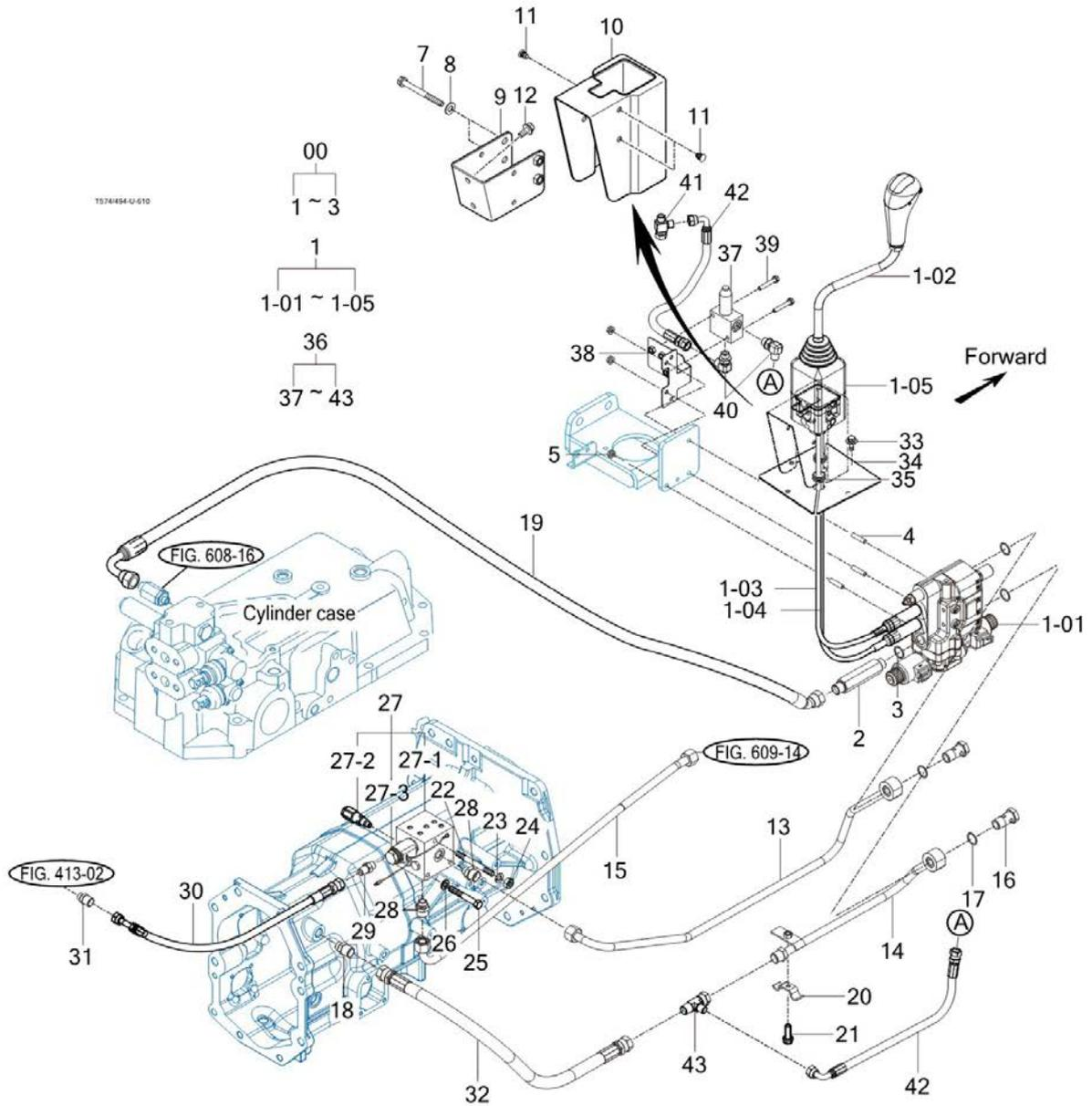

NOTE

FIG 610		JOYSTICK					년/월	
							Year/Month	
T494NH		2022-12						
KEY NO	PART NO	DESCRIPTION	SPEC	QTY	REPAIR	EFFECTIVE DATE	REMARKS	
610	0	13877753000	LOADER VALVE SUB		1			
610	1	13877752000	JOYSTIC ASSY , LOADER VALVE		1			
610	1.1	13877752100	LOADER VALVE ASSY		1			
610	1.2	13877752200	JOYSTIC LEVER ASSY		1			
610	1.3	13877752300	JOYSTIC CABLE ASSY ,UPR(720)		1			
610	1.4	13877752400	JOYSTIC CABLE ASSY ,LOW(770)		1			
610	1.5	13877752500	BOOT ASSY		1			
610	2	13805410050	UNION , PF1/2-130		1			
610	3	19557753010	BONDED SEAL , PF1/2		1			
610	4	V2513408025	BOLT , STUD/2	M8X25	3			
610	5	V3802600080	NUT , HEX FLANGE	M8	3			
610	7	V2173608085	BOLT , HEX/S	M8X85	2			
610	8	V4111600080	WASHER , PLAIN	M8	2			
610	9	14527103100GB	BRACKET , JOYSTICK	T=3.2	1			
610	10	14527100010	COVER , JOYSTICK T483	T=2.5	1			
610	11	15276040020	CLIP , TRIM	1X1X1	3			
610	12	V2183608020	BOLT , HEX/SP	M8X20	2			
610	13	13875412100GB	PIPE COMP , LOADER P		1			
610	13	13875412101GB	PIPE COMP , LOADER P		1			
610	14	13875412200GB	PIPE COMP , LOADER T		1			
610	14	13875412201GB	PIPE COMP , LOADER T		1			
610	15	13875102201GB	PIPE COMP , MAIN RR		1			
610	16	13875410081	BOLT , EYE JOINT(PF1/2)		2			
610	16	13875410080	BOLT , EYE JOINT(PF1/2)		2			
610	16	13875410082	BOLT , EYE JOINT(PF1/2)		2			
610	17	19555410060	WASHER , GASKET PF1/2		4			
610	17	19557753010	BONDED SEAL , PF1/2		4			
610	18	17995161130	UNION , PF3/8 PF1/2		1			
610	19	13875202300	HOSE ASSY , HYD 1550		1			
610	20	18715404700	CLIP		1			
610	21	V2173608016	BOLT , HEX/S	M8X16	1			
610	22	V2513408090	BOLT , STUD/2	M8X90	1			
610	23	V4011600080	WASHER , SPRING	M8	1			
610	24	V3042600080	NUT , HEX/2	M8	1			
610	25	V2013608090	BOLT , HEX	M8X90	2			
610	26	V4011600080	WASHER , SPRING	M8	1			
610	27	13875182000	VALVE ASSY , PTO		1			
610	27	17975182001	VALVE ASSY , PTO		1			
610	27-1	14725182100	VALVE , PTO		1			
610	27-2	16490110001	VALVE ASSY , RELIEF		1			
610	27-3	14725182210	SOLENOID COIL		1			
610	28	14135160010	UNION, PF3/8 M22		2			
610	29	37681850141	ADAPTER , STRAIGHT		1			
610	30	18717562060	HOSE ASSY , HYD 520		1			
610	31	17971850140	ADAPTER , STRAIGHT PF1/4	1X1X1	1			
NOTE								

FIG 612

HITCH & 3-POINT LINK

년/월
Year/Month

2022-12

T494NH

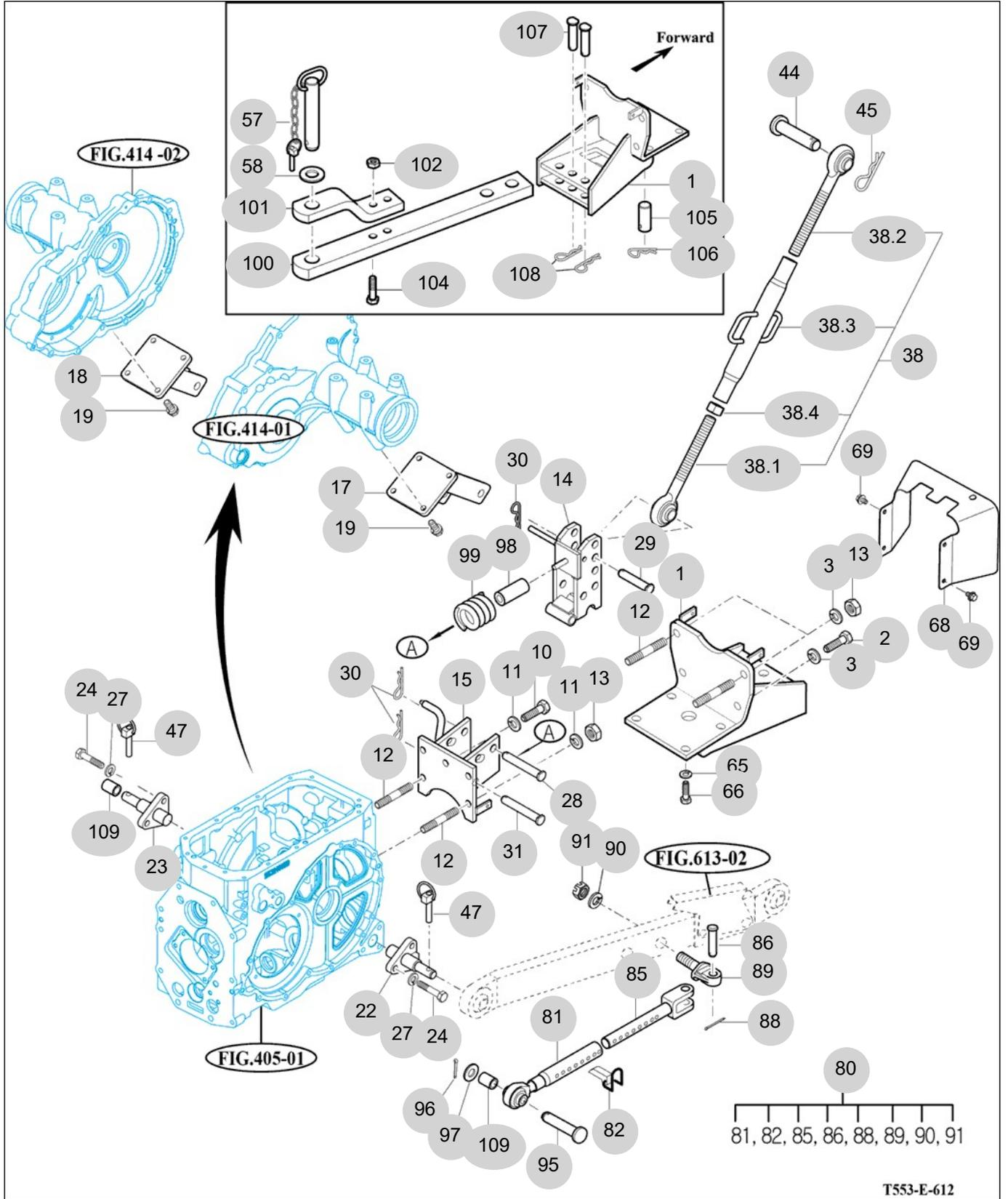

T553-E-612

NOTE

FIG 612		HITCH & 3-POINT LINK					년/월 Year/Month		
							2022-12		
T494NH		KEY NO	PART NO	DESCRIPTION	SPEC	QTY	REPAIR	EFFECTIVE DATE	REMARKS
612	1	15535202001GB	BRACKET COMP, SWING DRAWBAR			1			
612	1	15535202002GB	BRACKET COMP, SWING DRAWBAR			1			
612	1	15535202003GB	BRACKET COMP, SWING DRAWBAR			1			
612	2	V2013616035	BOLT, HEX	M16X35		2			
612	3	V4011600160	WASHER, SPRING	M16		4			
612	10	V2013616035	BOLT, HEX	M16X35		3			
612	11	V4011600160	WASHER, SPRING	M16		5			
612	12	V2513416035	BOLT, STUD/2	M16X35		4			
612	13	V3043600160	NUT, HEX/2	M16		4			
612	14	16735222102GB	LINK COMP	1X1X1		1			
612	15	15185222000GB	BRACKET COMP			1			
612	17	14525254100GB	BRACKET COMP, RR			1			
612	18	14525254100GB	BRACKET COMP, RR			1			
612	19	V2173612030	BOLT, HEX/S	M12X30		8			
612	22	15685252204	PIN COMP, LH			1			
612	23	15685252801	PIN COMP, RH			1			
612	24	V2013614040	BOLT, HEX	M14X40		6			
612	27	V4011600140	WASHER, SPRING	M14		6			
612	28	15645250010	PIN, 19X122	D=19		1			
612	29	15645220020	PIN, 19X95	D=19		1			
612	30	14445140051	PIN, 19	D=4.5		3			
612	31	15645250010	PIN, 19X122	D=19		1			
612	38	16505245501GB	LINK ASSY, TOP LINK			1			
612	38	16505245502GB	TOP LINK ASSY			1			
612	44	15645220011	PIN, 19X86	D=19		1			
612	45	14445140051	PIN, 19	D=4.5		1			
612	47	14215020020	PIN, LINK			2			
612	57	S0973063031	PIN ASSY	1X1X1		1			
612	58	15252470010	RUBBER, CUSHION			1			
612	65	V4011600140	WASHER, SPRING	M14		4			
612	66	V2013614035	BOLT, HEX	M14X35		4			
612	68	13605200012GB	COVER, SHIELD	1X1X1		1			
612	69	V2183608016	BOLT, HEX/SP	M8X16		4			
612	80	15155253000GB	LINK ASSY, ADJUSTER	570*60*50		2			
612	81	15155253100	ROD SUB, FR	44*320*60		2			
612	82	17705254200	PIN	1X1X1		2			
612	85	15155253300	ROD SUB, REAR	340*50*50		2			
612	86	15155253400	PIN, ø20X59	ø20X59		2			
612	88	V5001940035	PIN, SPLIT	4X35		2			
612	89	15155253500	EYEBOLT	66*60*40		2			
612	90	V4111600220	WASHER, PLAIN	M22		2			
612	91	V3343600220	NUT, HEX FINE/2	M22		2			
612	95	15645220020	PIN, 19X95	D=19		2			
612	96	V5001950035	PIN, SPLIT	5X35		2			
612	96	14445140051	PIN, 19			2			
NOTE									

FIG 613

LOWER LINK & LIFT ROD

년/월
Year/Month

2022-12

T494NH

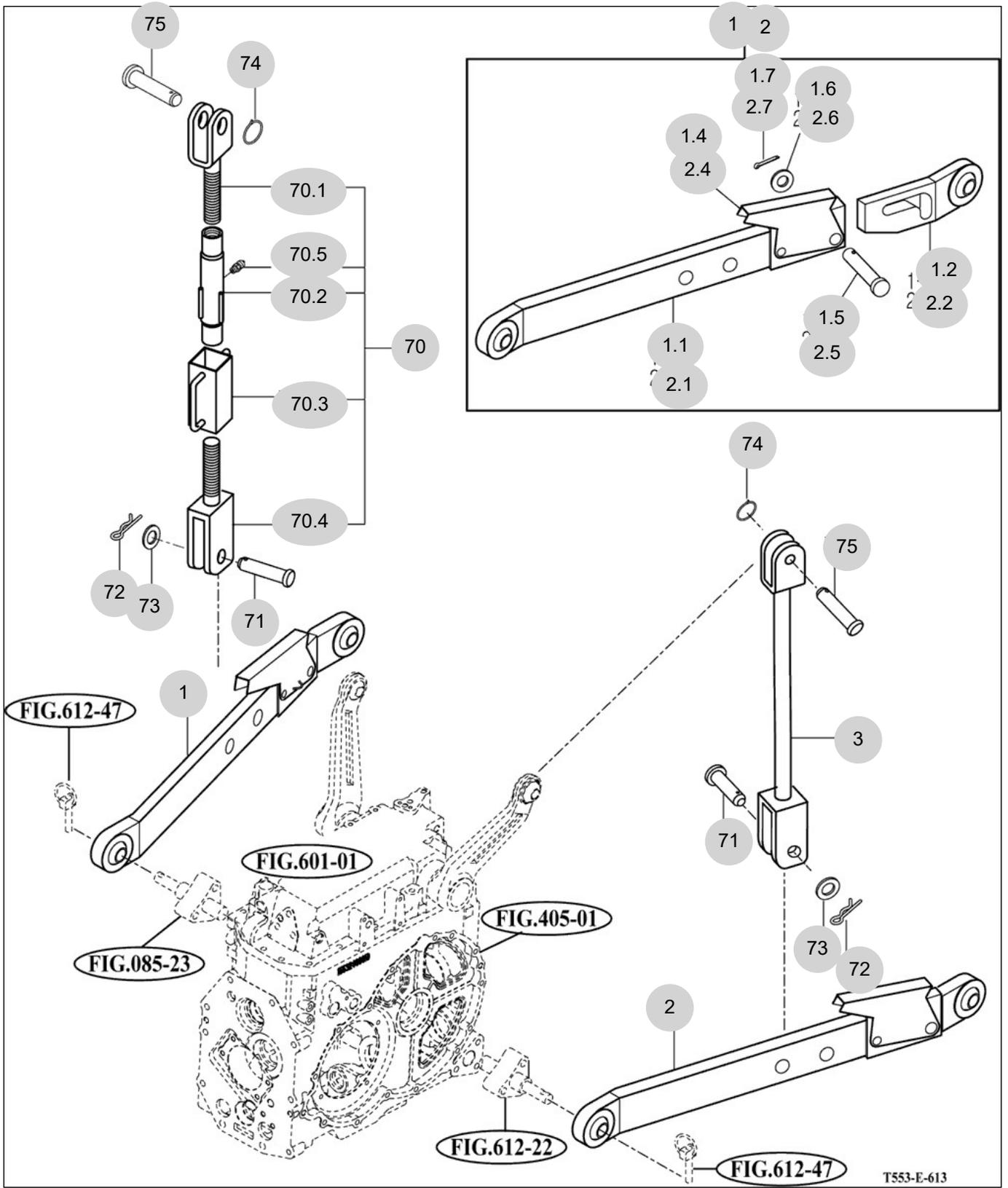

NOTE

7. Sheet Metal & Cabin PART NO. T7

FIG 701 BONNET FRAME	213
FIG 702 BONNET (1)	215
FIG 702-2 BONNET (2)	217
FIG 703 EXTENSION COVER	219
FIG 704-2 LEVER COVER & STEP-NON CAB	221
FIG 705 FRONT & REAR MOUNTING	223
FIG 706 SEAT & MAT	225
FIG 710-2 FRAME & 2POLES-ROPS-NON CAB	227
FIG 713-2 SUB FENDER & COVER-NON CAB	229
FIG 714-2 MIRROR&WORKING LAMP-NON CAB	231

FIG 701

BONNET FRAME

년/월
Year/Month

2022-12

T494NH

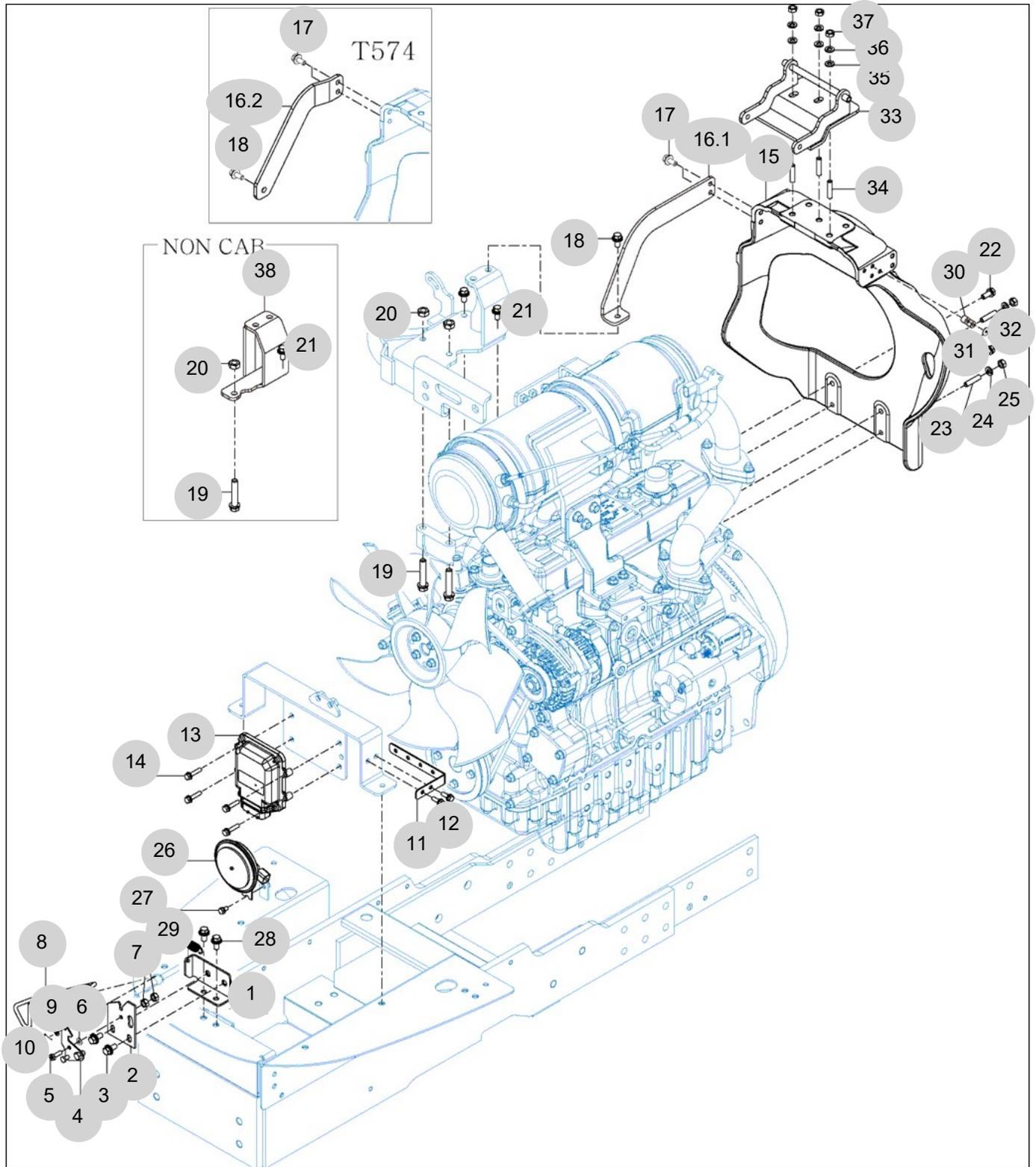

NOTE

FIG 702

T494NH

BONNET (1)

년/월
Year/Month

2022-12

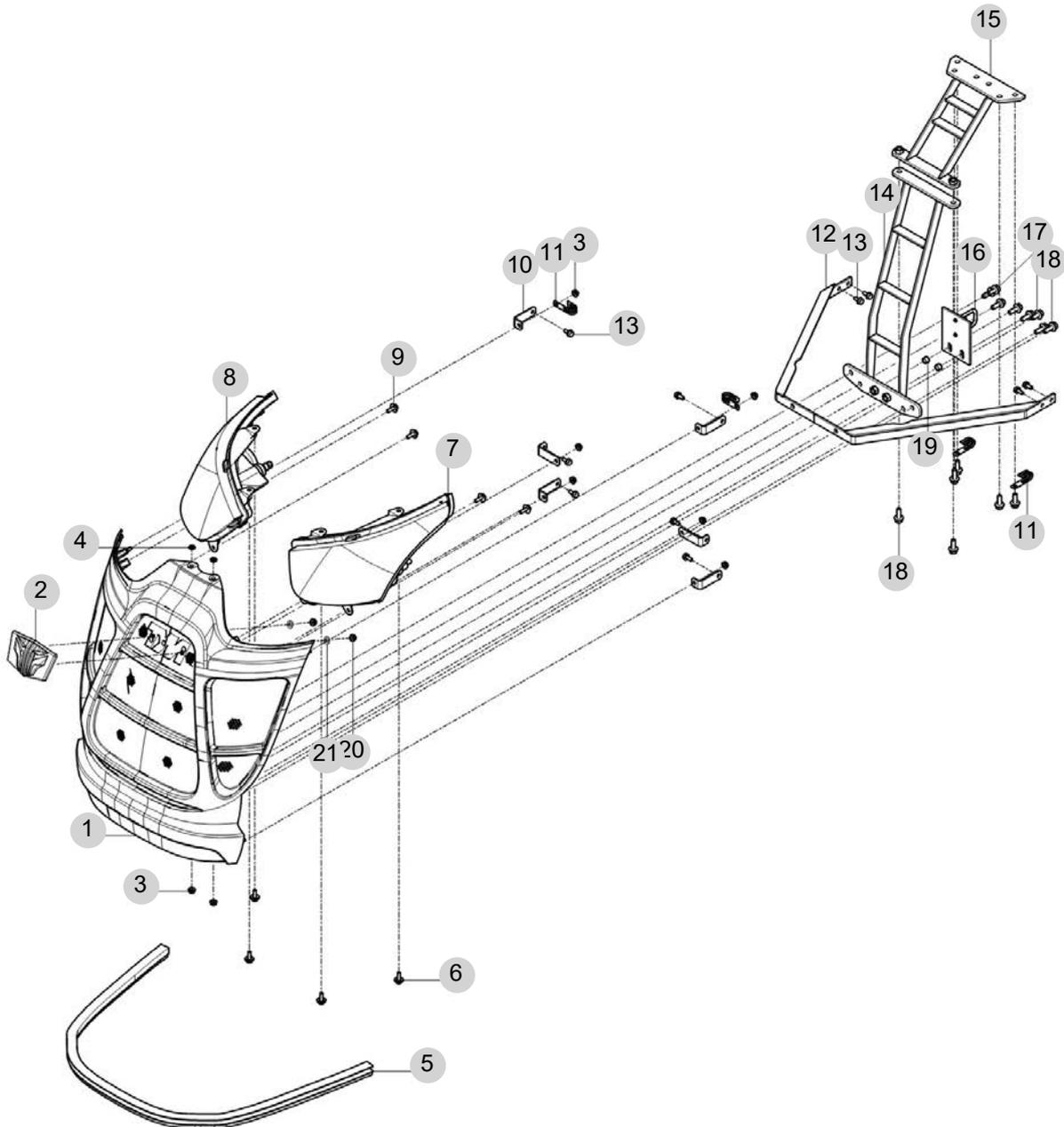

NOTE

FIG 702-2

T494NH

BONNET (2)

년/월
Year/Month

2022-12

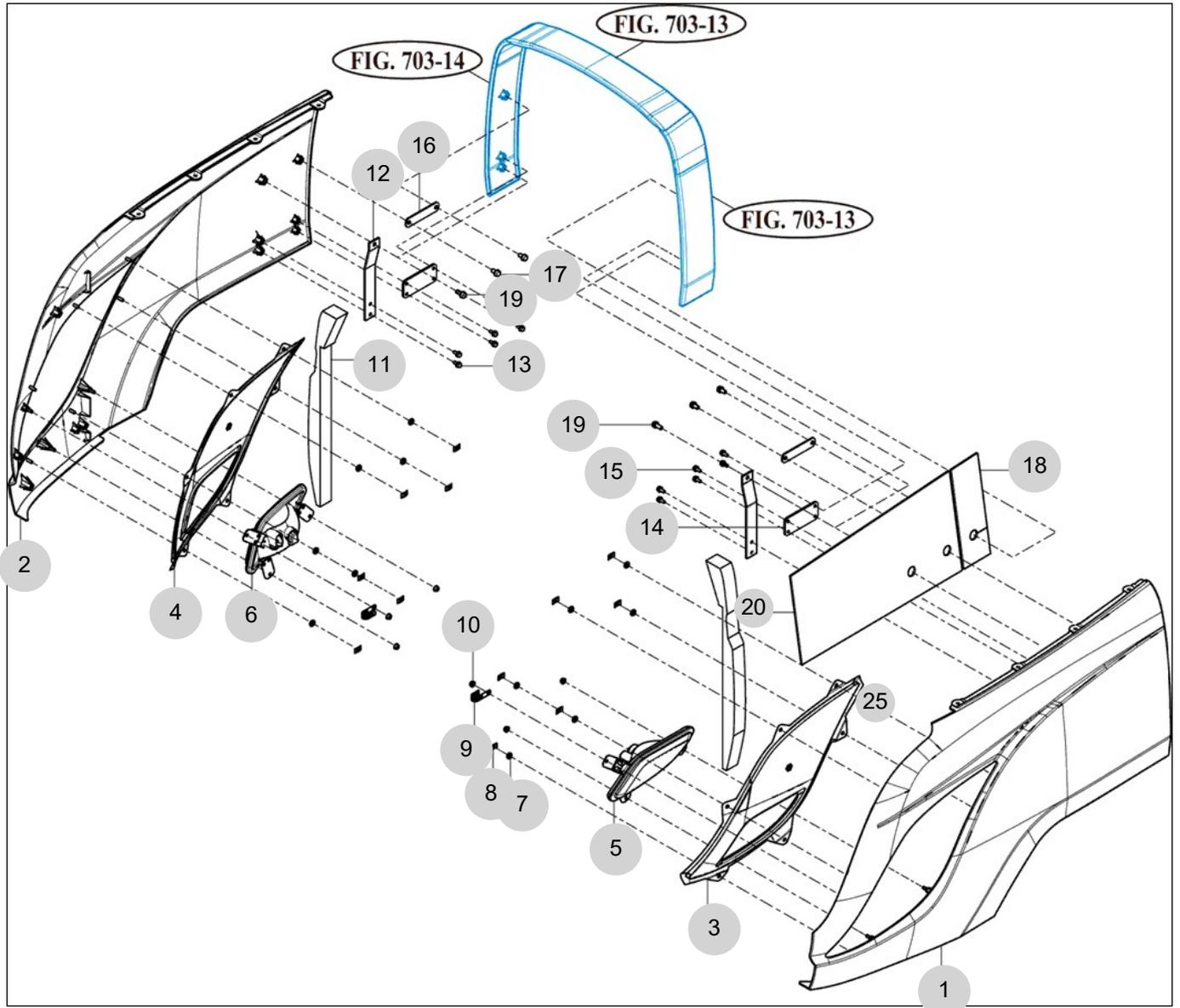

NOTE

FIG 703

EXTENSION COVER

년/월
Year/Month

2022-12

T494NH

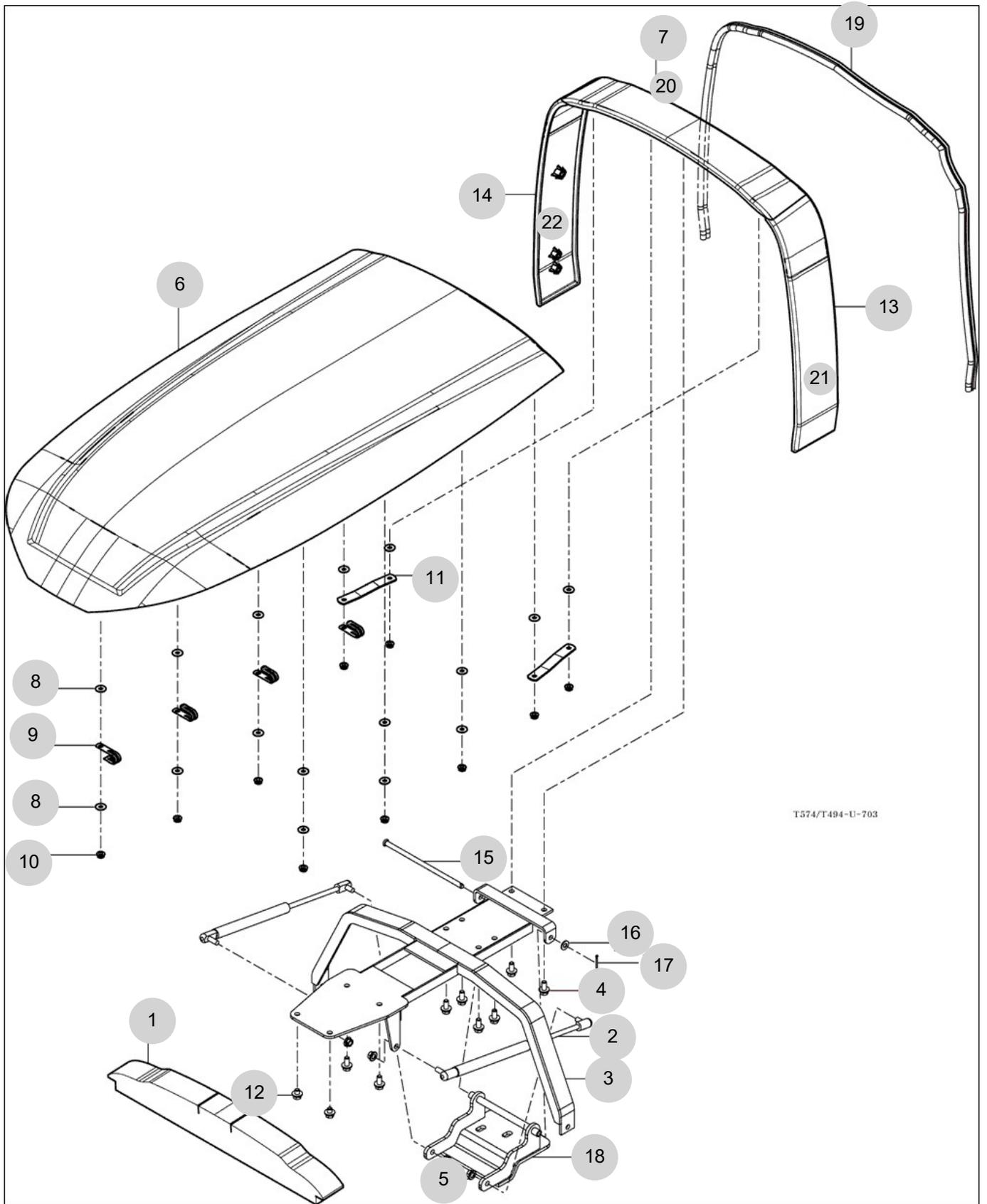

T574/T494-U-703

NOTE

T494NH

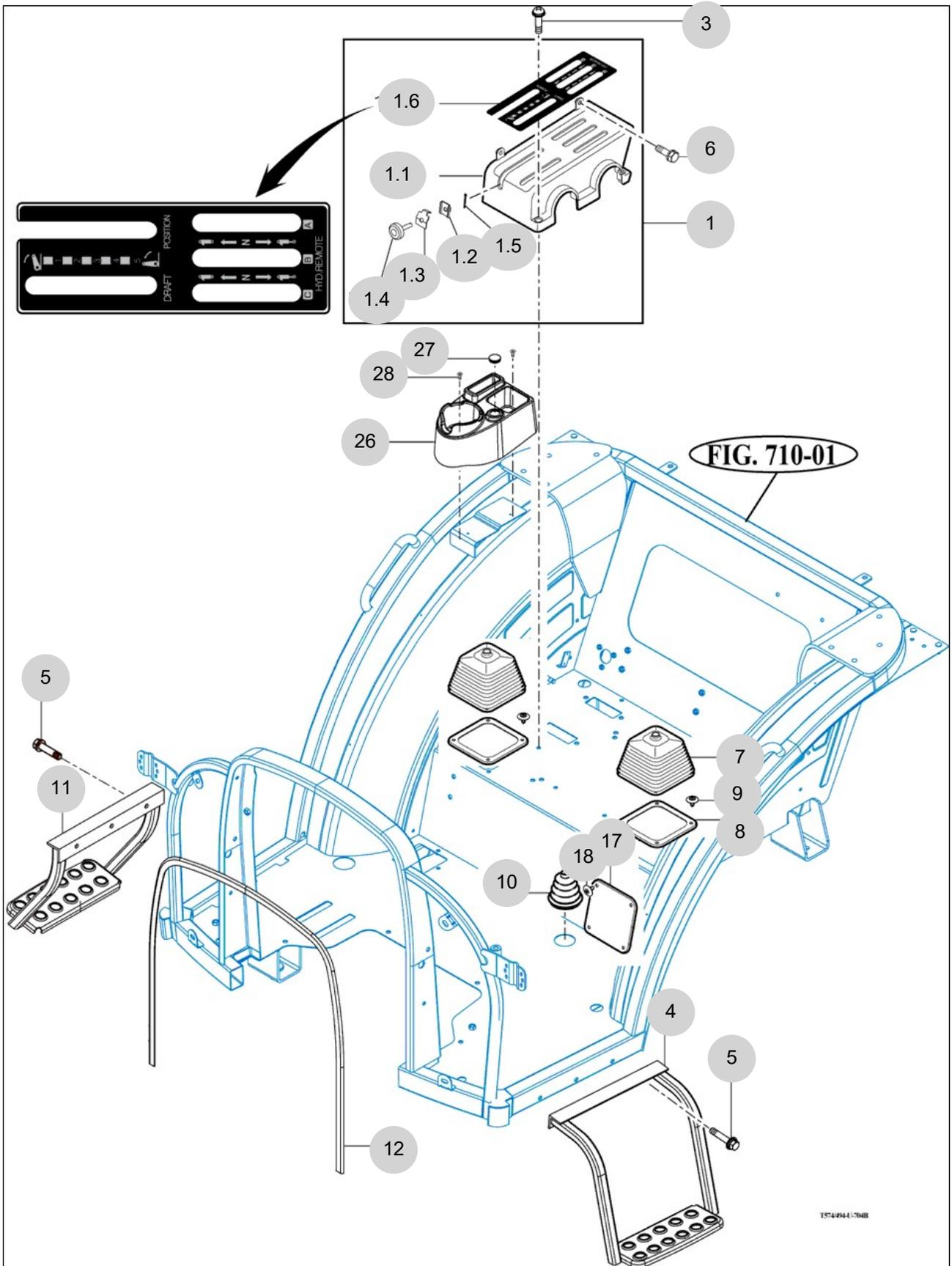

NOTE

FIG 705

T494NH

FRONT & REAR MOUNTING

년/월
Year/Month

2022-12

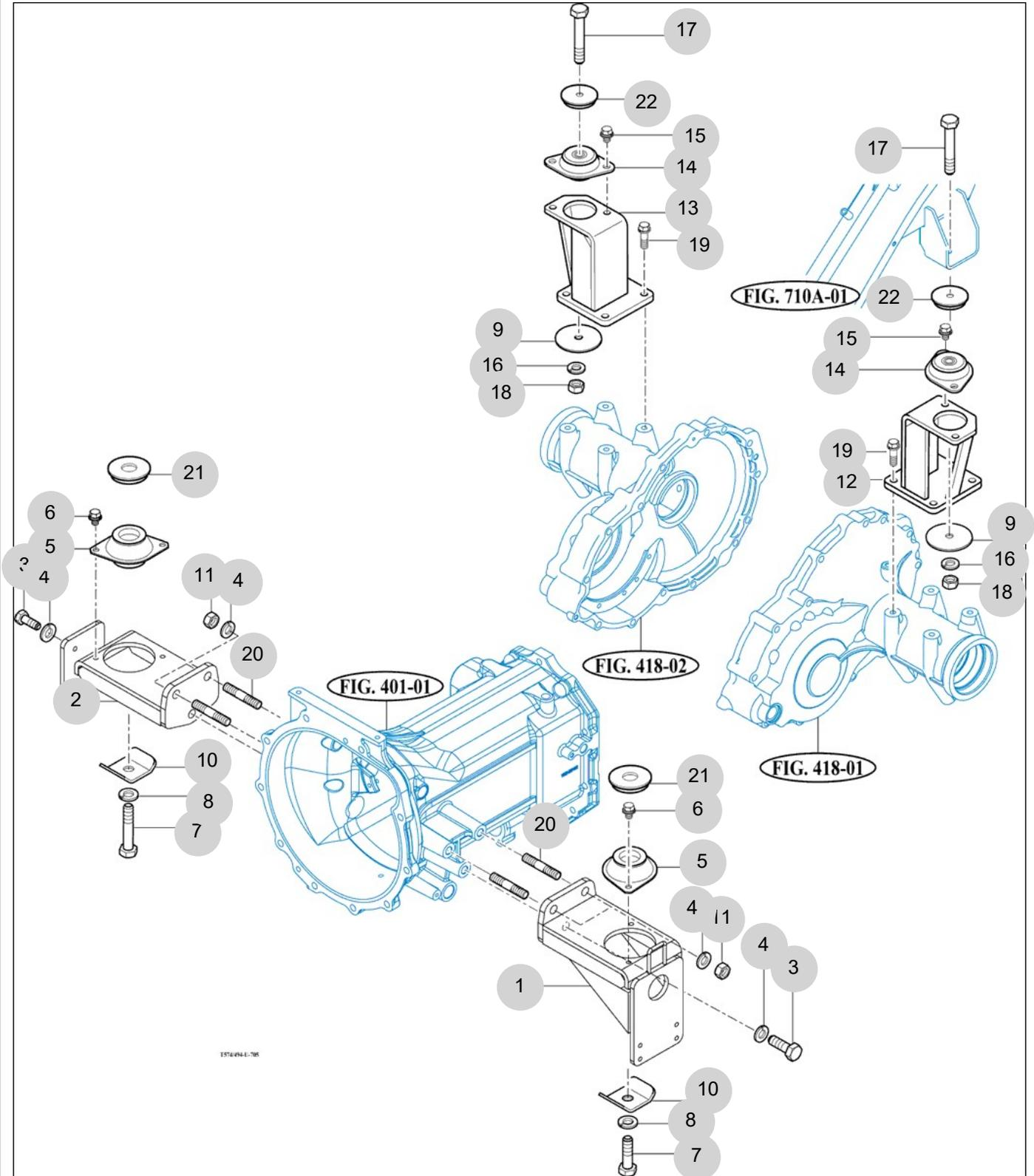

NOTE

FIG 706

SEAT & MAT

년/월
Year/Month

2022-12

T494NH

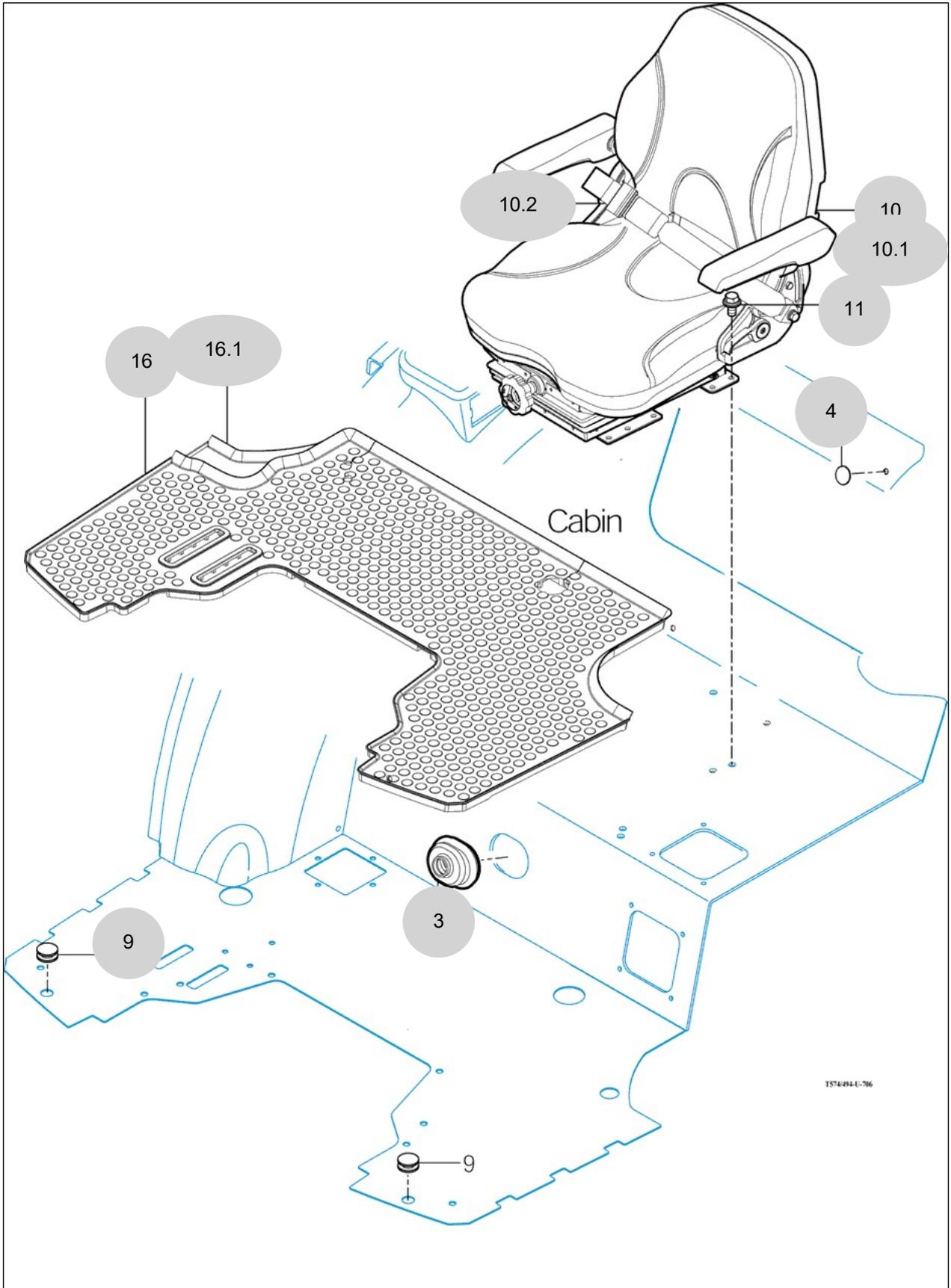

NOTE

FIG 710-2

FRAME & 2POLES-ROPS-NON CAB

년/월
Year/Month

2022-12

T494NH

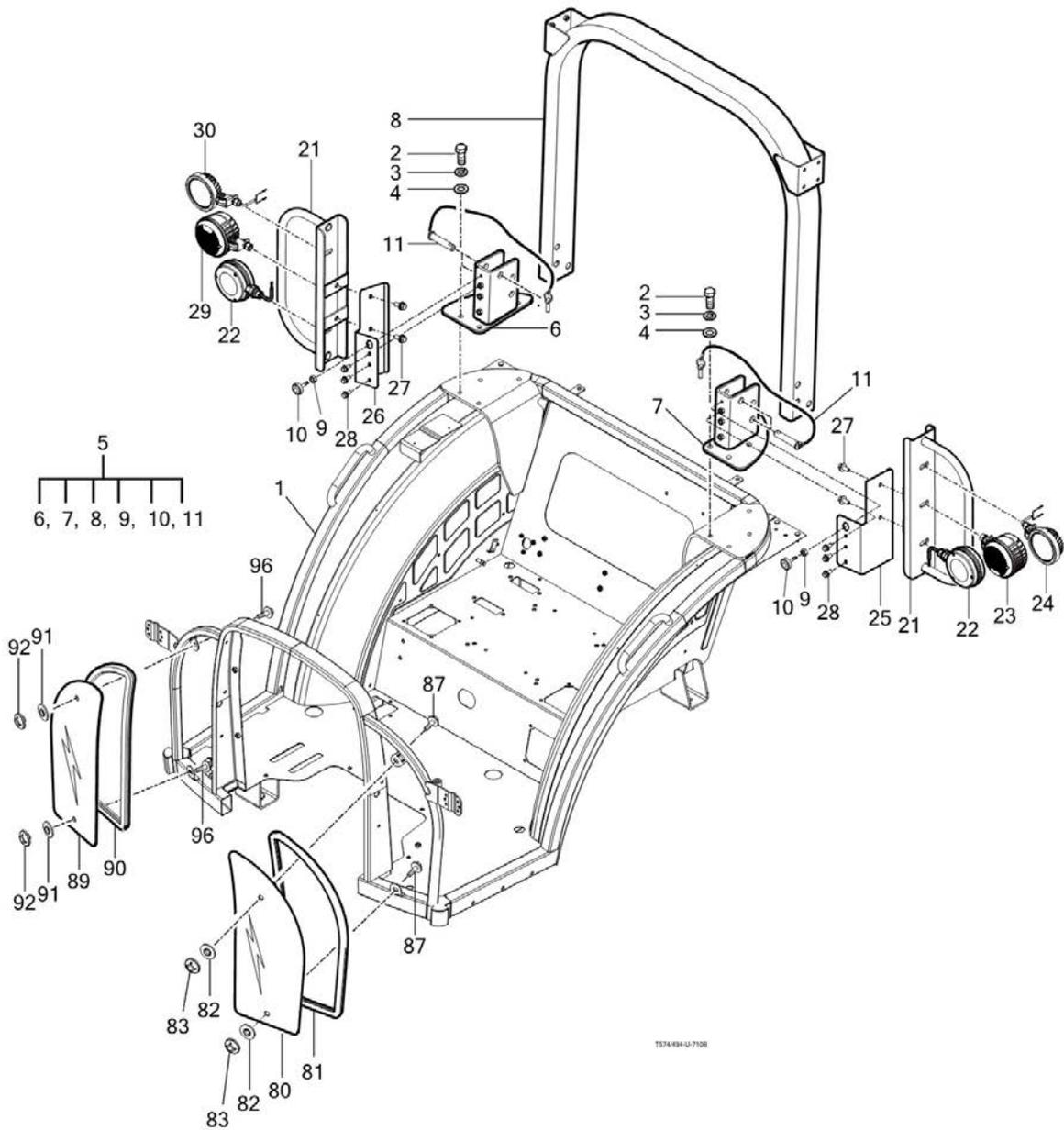

T3741084-01-7102

NOTE

FIG 713-2

SUB FENDER & COVER-NON CAB

년/월
Year/Month

2022-12

T494NH

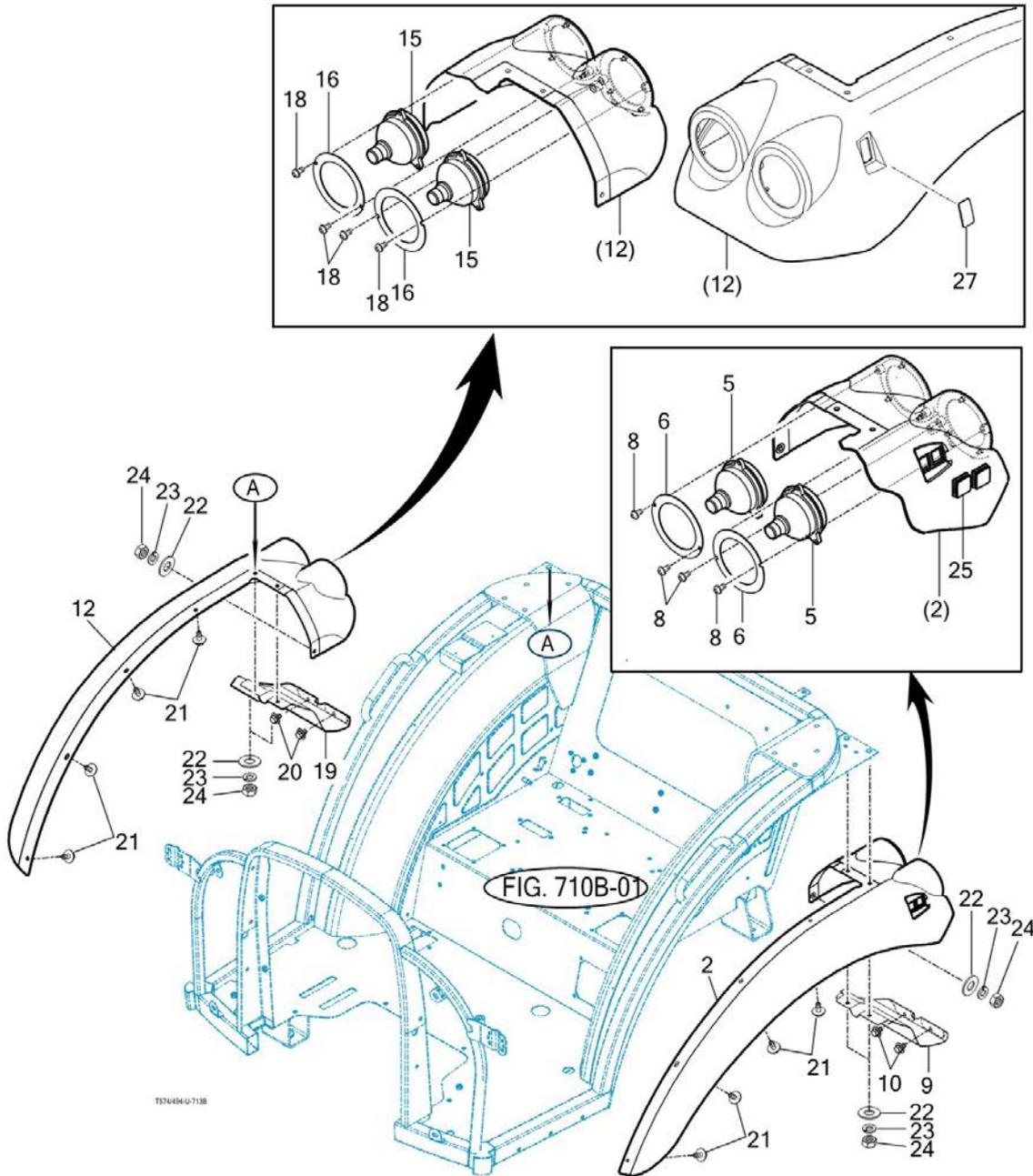

NOTE

FIG 714-2

MIRROR&WORKING LAMP-NON CAB

년/월
Year/Month

2022-12

T494NH

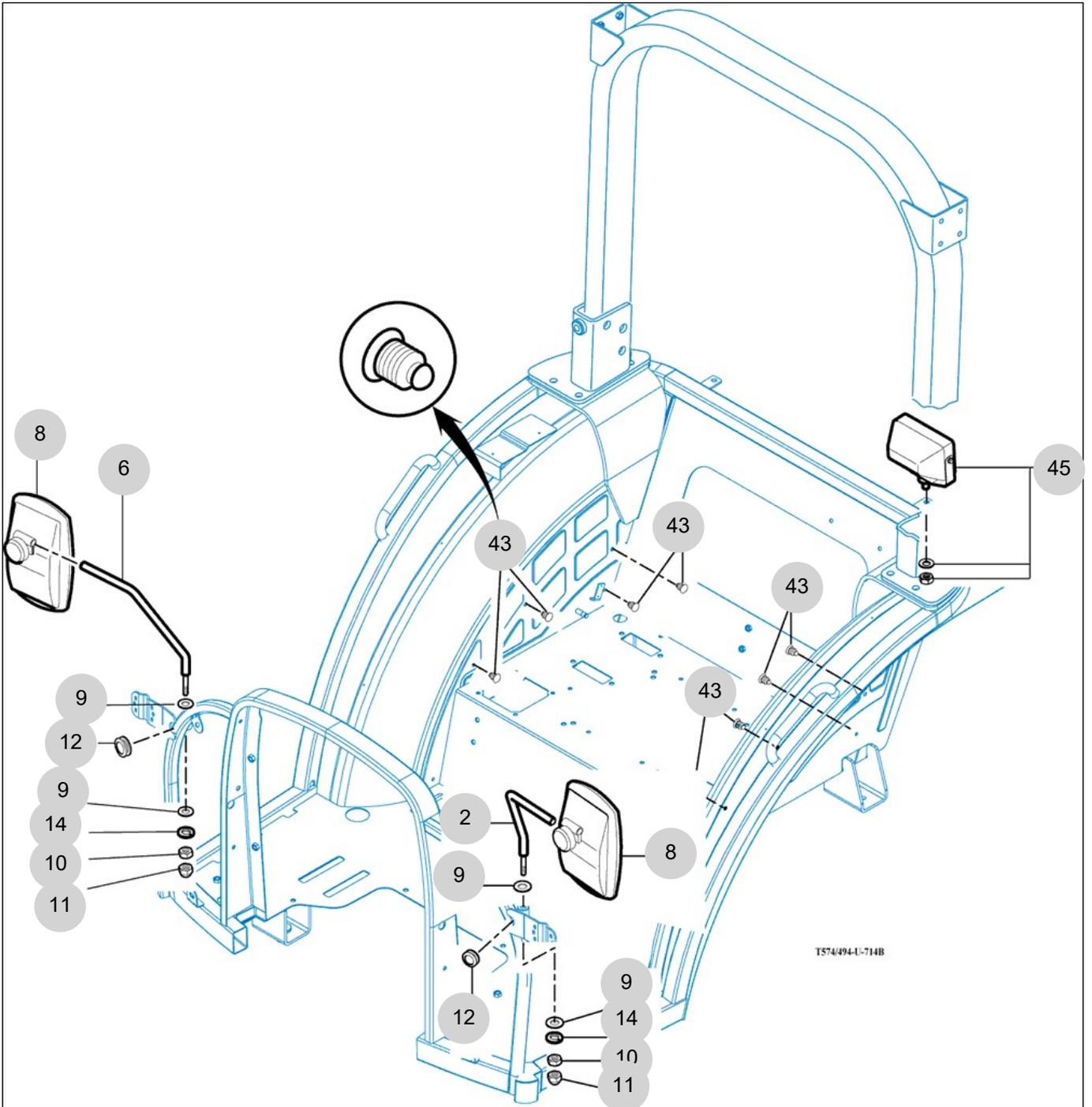

NOTE

8. Electrical System PART NO. T8

FIG 801 BATTERY & MOUNTING	234
FIG 802 HARNESS LAMP	236
FIG 803 INSTRUMENT PANEL	238
FIG 804 ELECTRIC SYSTEM (1)	240
FIG 805-2 ELECTRIC SYSTEM (2)-NON CAB	242
FIG 806 ELECTRIC SYSTEM (3)	244

FIG 801

T494NH

BATTERY & MOUNTING

년/월
Year/Month

2022-12

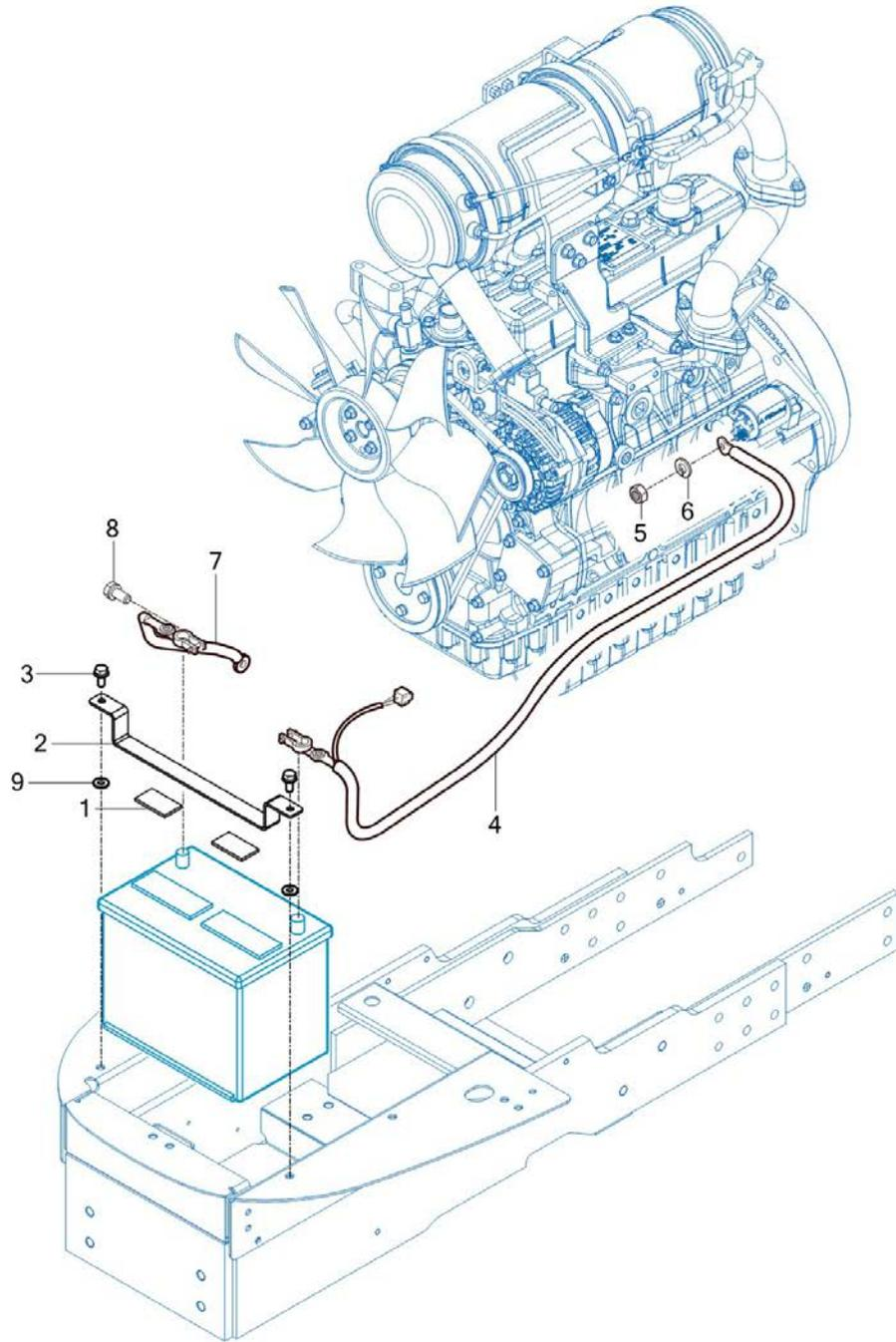

NOTE

FIG 802

HARNES LAMP

년/월
Year/Month

T494NH

2022-12

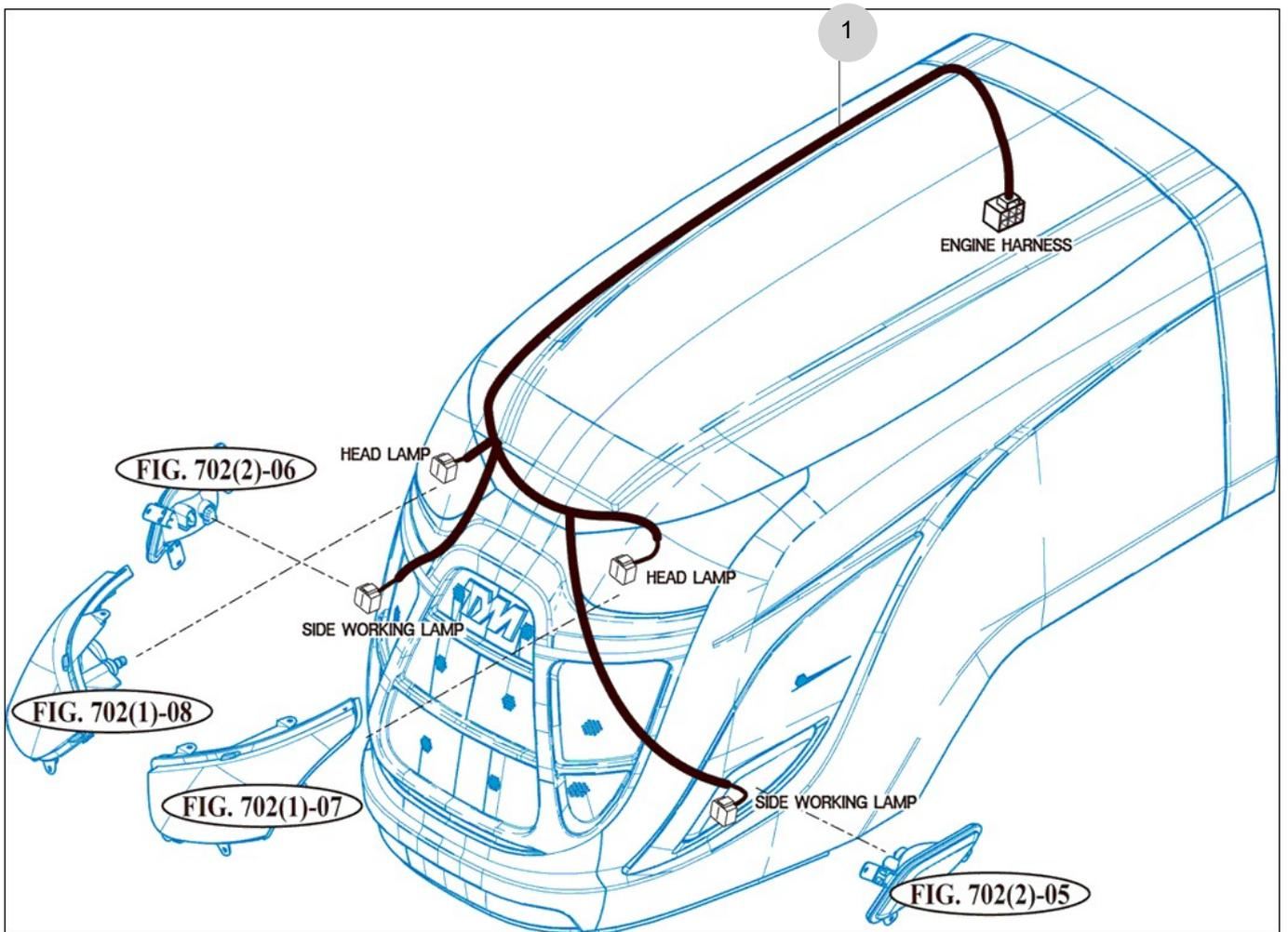

NOTE

FIG 803

INSTRUMENT PANEL

년/월
Year/Month

T494NH

2022-12

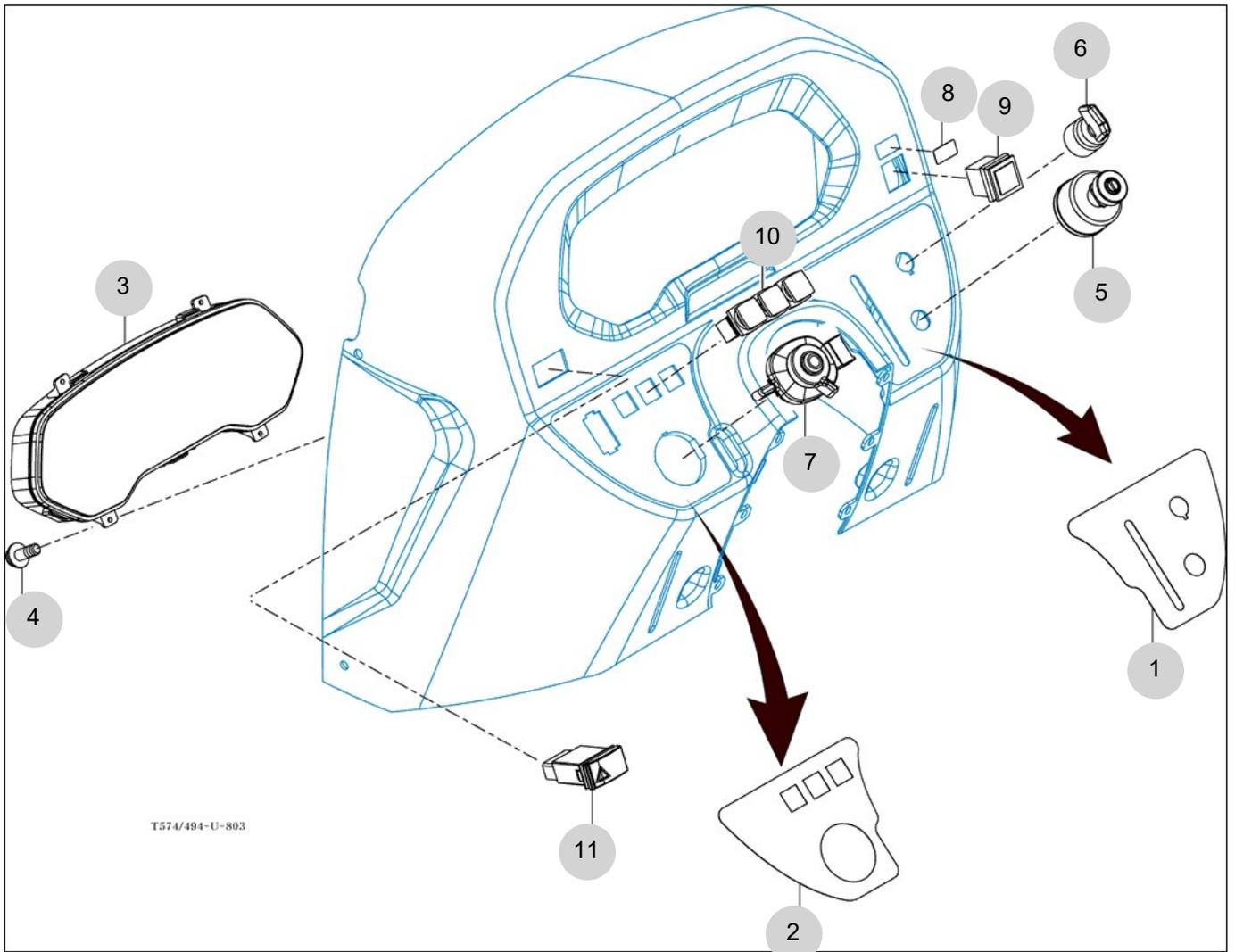

NOTE

FIG 804

T494NH

ELECTRIC SYSTEM (1)

년/월
Year/Month

2022-12

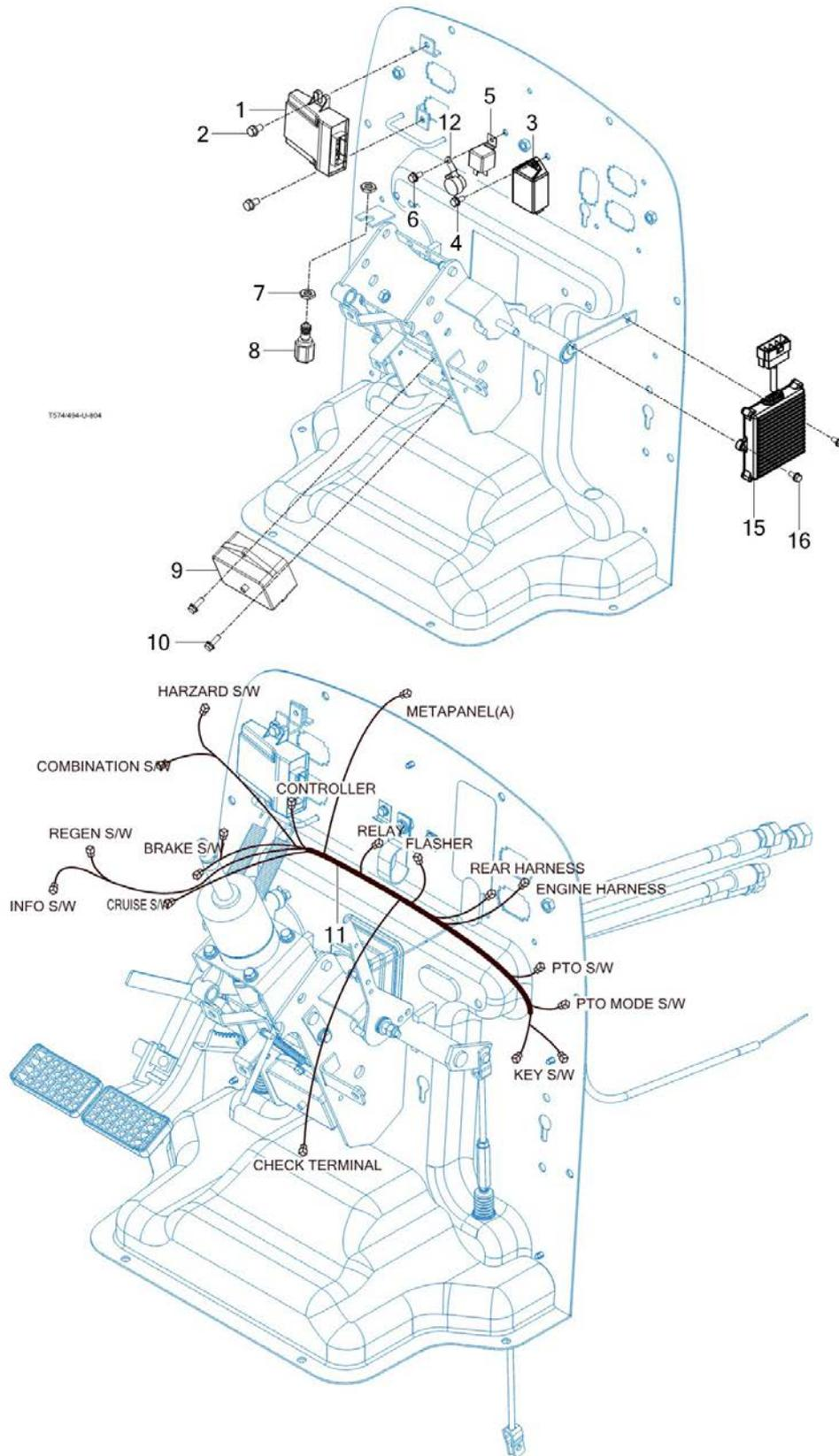

NOTE

FIG 805-2

ELECTRIC SYSTEM (2)-NON CAB

년/월
Year/Month

T494NH

2022-12

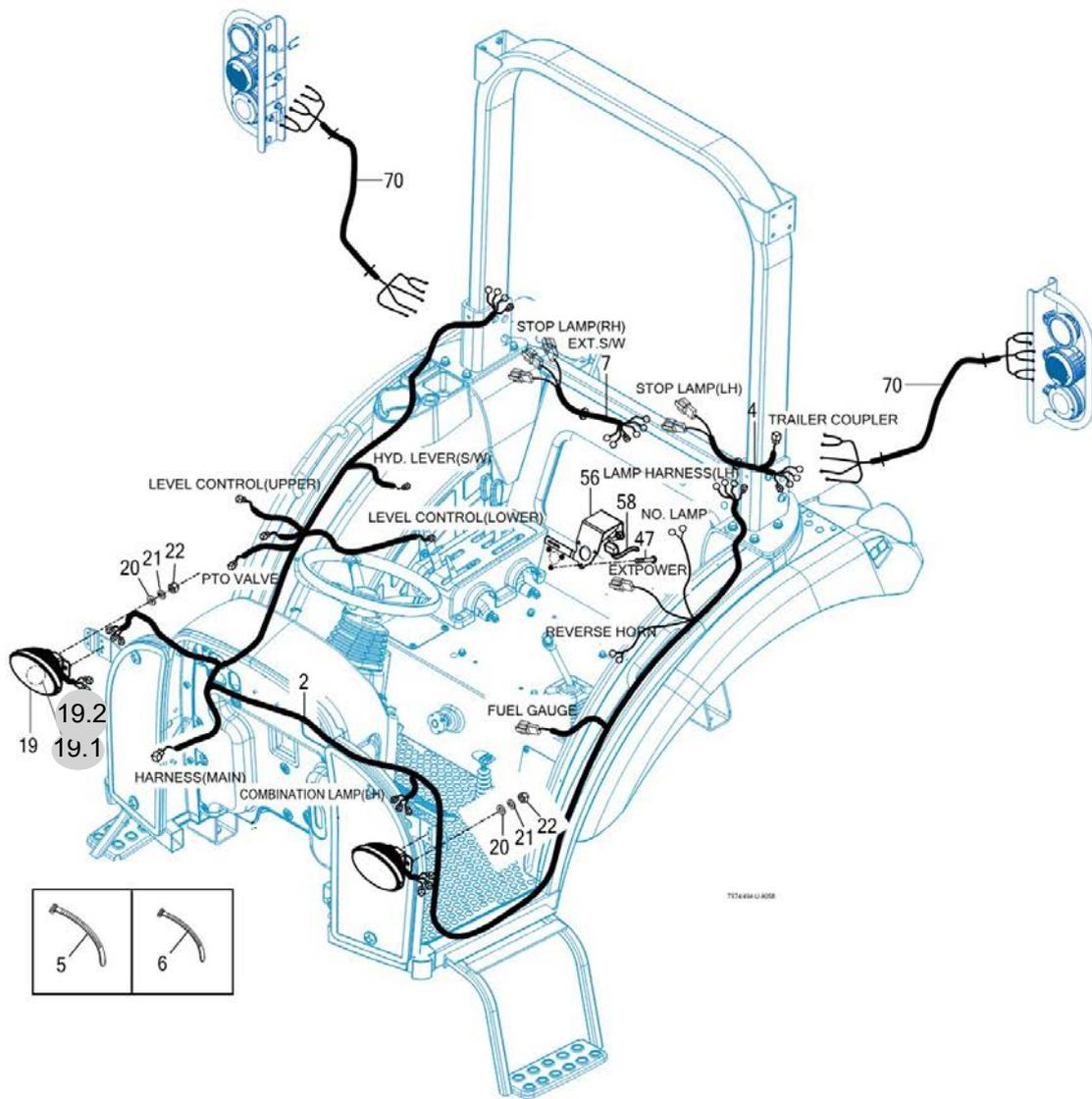

NOTE

FIG 806

ELECTRIC SYSTEM (3)

년/월
Year/Month

T494NH

2022-12

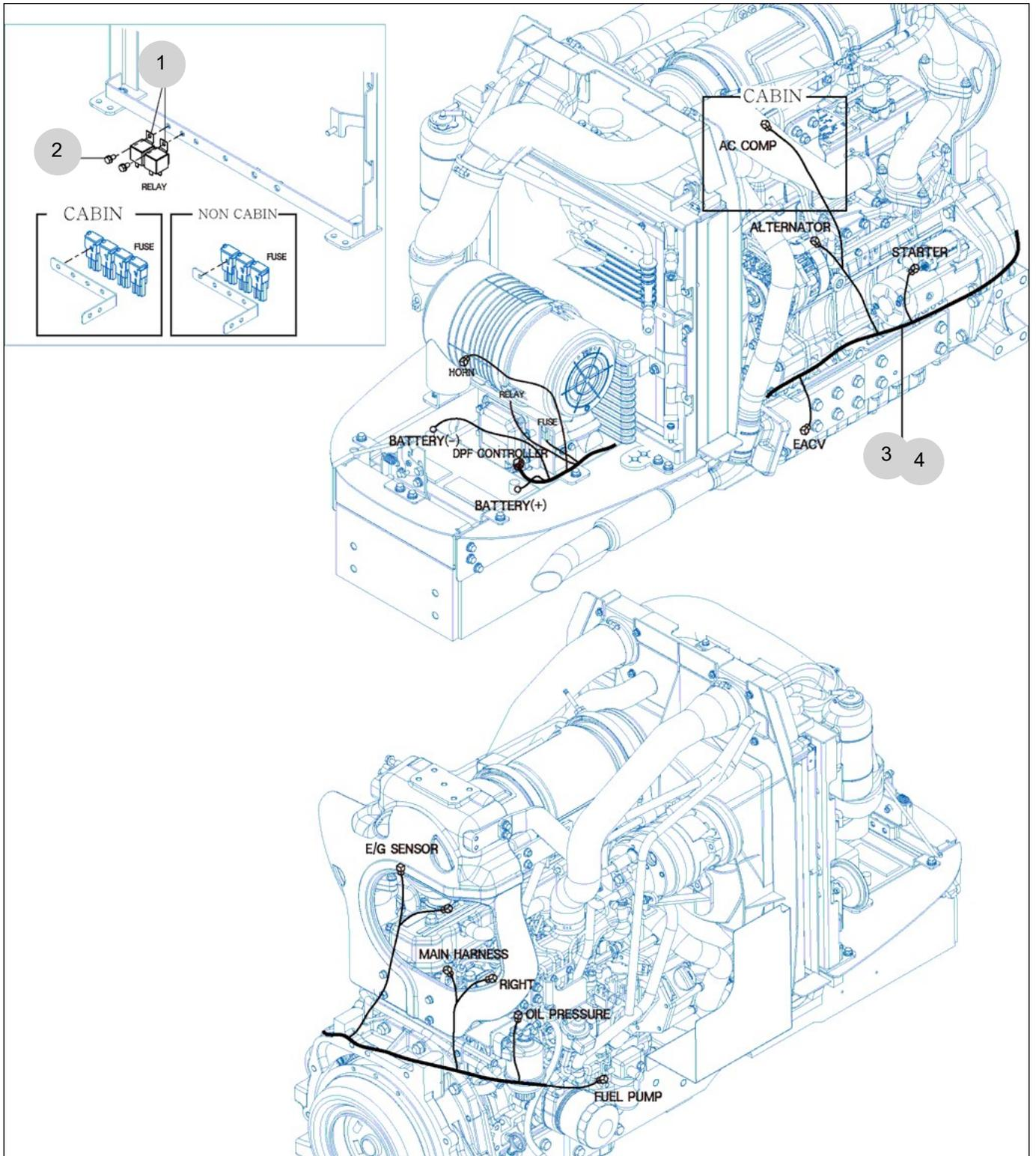

NOTE

9. Label/Option PART NO. T9

FIG 901 TOOL & ACCESSORY	247
FIG 902 LABEL	249
FIG 902-2 LABEL	251
FIG 903 OPTION	253

FIG 901

T494NH

TOOL & ACCESSORY

년/월
Year/Month

2022-12

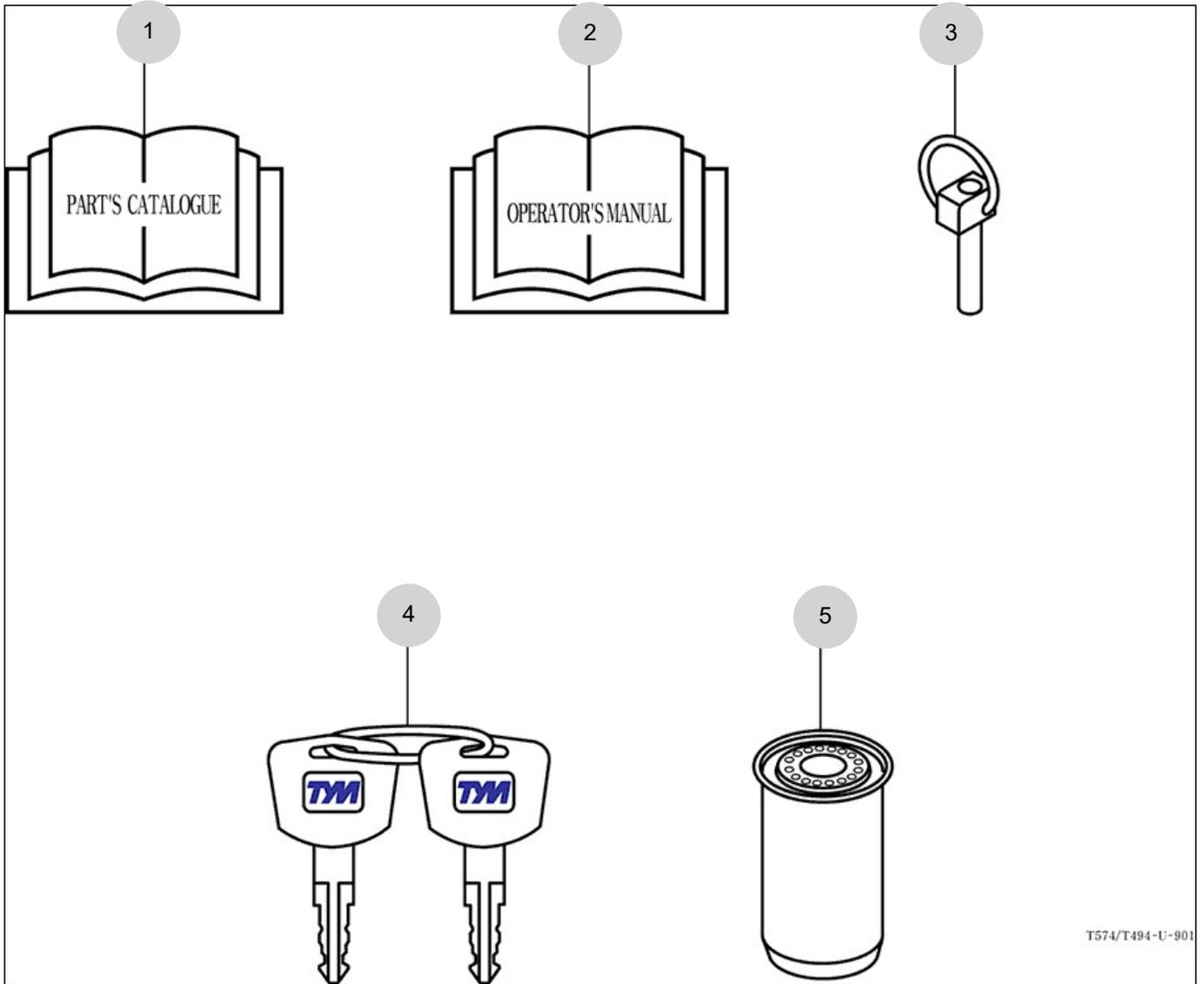

NOTE

FIG 902

LABEL

년/월
Year/Month

T494NH

2022-12

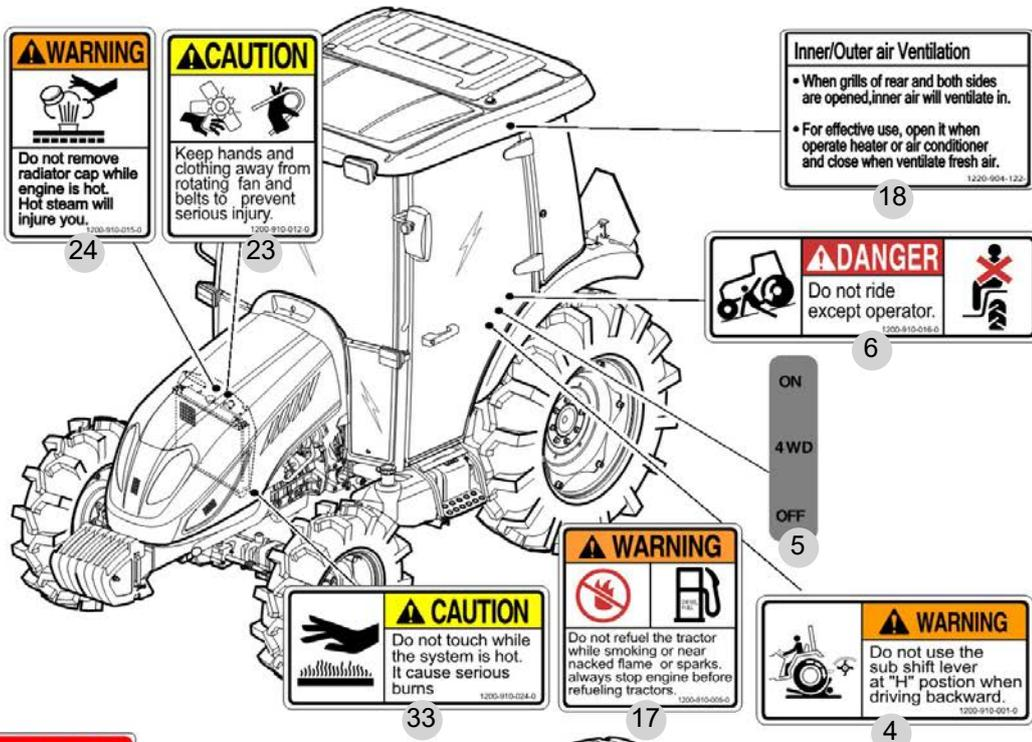

DANGER
This Tractor may tip over unexpectedly and quicker than an operator is able to jump free.
1. Never operate a tractor without a proper Roll Over Protection Structure (ROPS)
2. Always wear your seat belt when operating this tractor equipped with roll over protection.
3. Never pull from above or from the rear axle.
4. Do not operate the tractor on steep slopes or near drop offs.
5. Avoid sharp high speed turns.
Serious injury or death may result from tractor upsets.
39

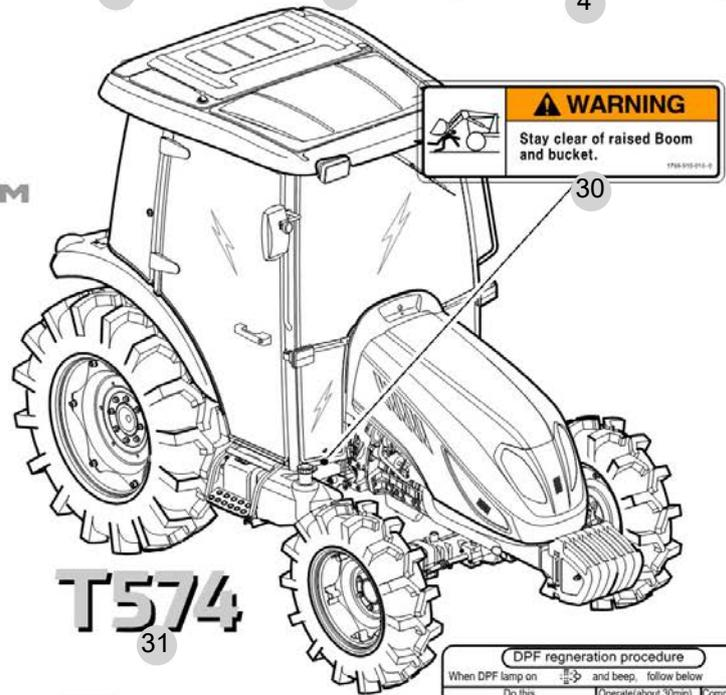

WARNING
Additions, alterations, cracking, damage or corrosion to this structure may adversely affect the performance of the ROPS.
40

WARNING
Death or injury may result if this tractor over turns with the ROPS in the folded down position. Operate this tractor with the ROPS folded down only when necessary. Do not wear seat belt if operated with ROPS folded down. 1220-904-102-0
41

DPF regeneration procedure

When DPF lamp on	Do this	Operate (about 30min)	Complete
1 Park outside safe location	2 Stop all functions.	3 Parking brake ON.	DPF+EGT ON + Button blinking Lamp off
4 Press clutch pedal (Mechanical)	5 Engine speed to Max RPM	6 Press the regen button	
6 Must remain with the vehicle			

For further details, consult your Owner's Manual. 1200-910-001-0
49

NOTE

FIG 902-2

LABEL

년/월
Year/Month

T494NH

2022-12

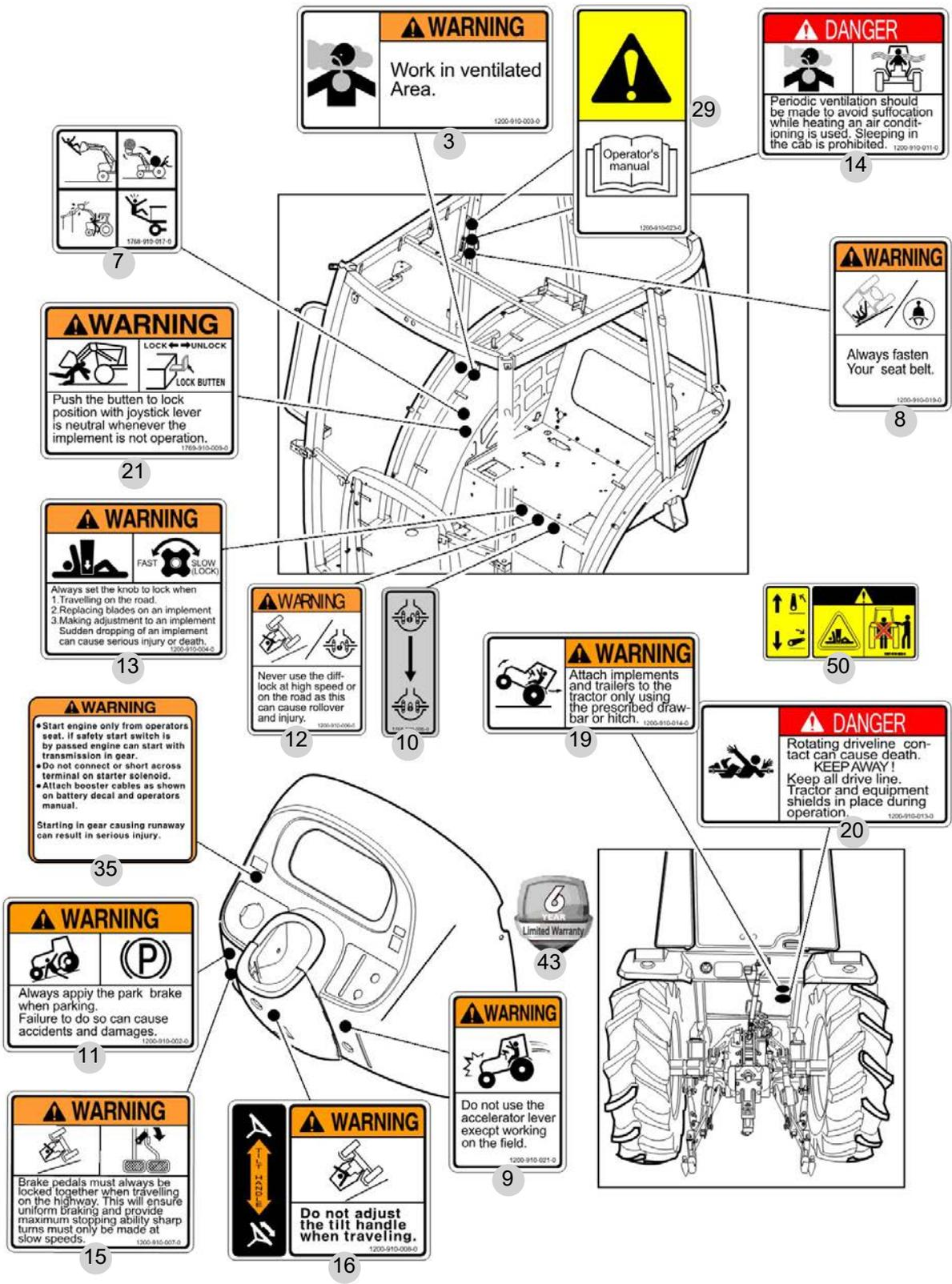

NOTE

FIG 903

OPTION

년/월
Year/Month

T494NH

2022-12

0

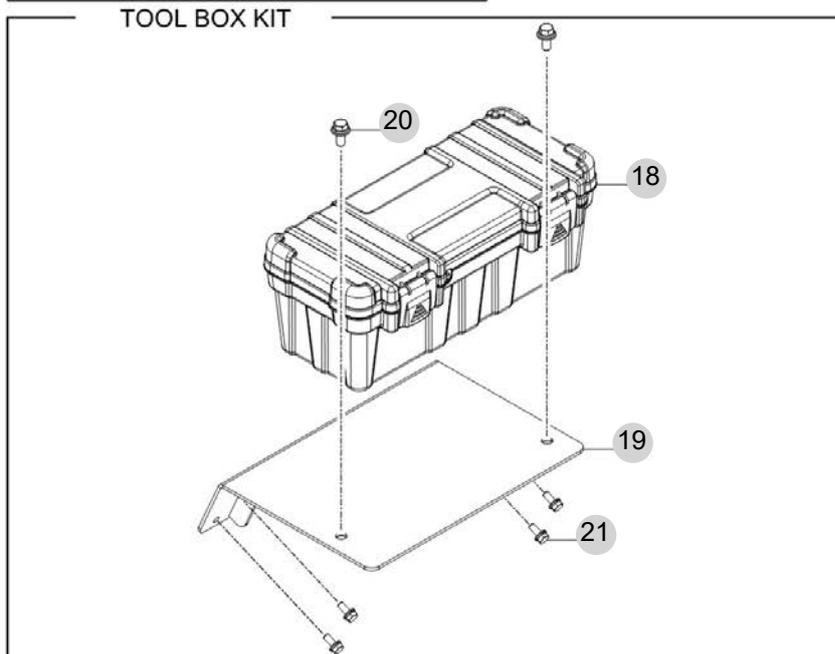
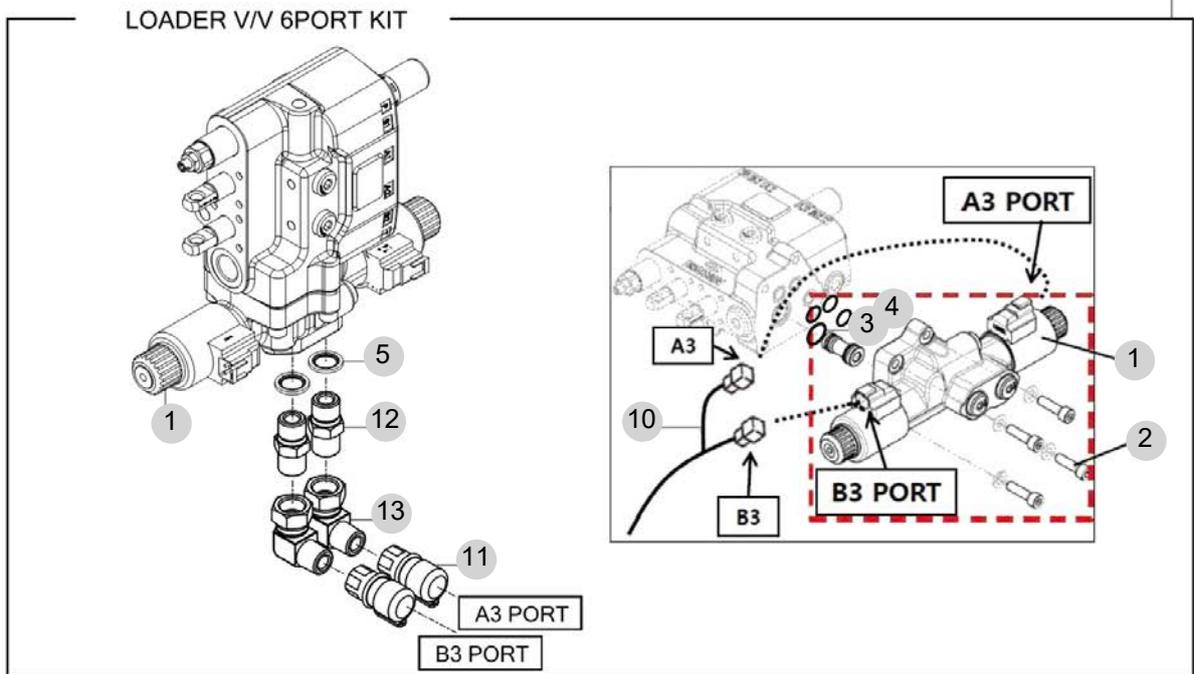

NOTE

